

OVOLUX

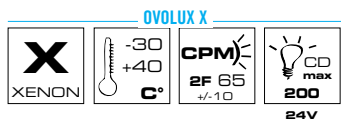

OVOLUX R

OVOLUX M
(con pressacavo M16)
(with M16 cable gland)
(avec presse-étoupe M16)

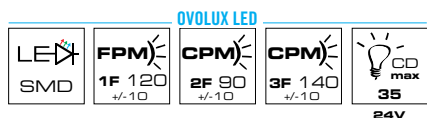
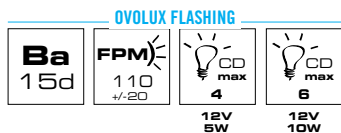
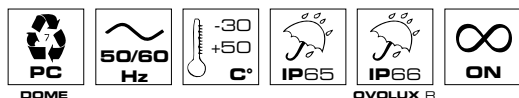

OVOLUX STEADY

| | |
|----------|--------------------------|
| V ACDC | 12 ÷ 24 ÷ 48 ÷ 110 ÷ 240 |
| mA (5W) | 430 210 100 35 22 |
| mA (10W) | 830 420 210 90 42 |

OVOLUX FLASHING

| | | | |
|----------|--------------|---------------------|-----------|
| V DC | 12 ÷ 24 ÷ 48 | - | - |
| V AC | - | 24 ÷ 48 ÷ 110 ÷ 240 | |
| mA (5W) | 430 | 210 | 100 35 22 |
| mA (10W) | 830 | 420 | 210 90 42 |

OVOLUX LED

| | | |
|--------|---------|----------|
| V ACDC | 12 ÷ 24 | - |
| V AC | - | 90 ÷ 240 |
| mA | 180 | 40 |

OVOLUX X

| | | | |
|--------|-----|-----|-----|
| V ACDC | 24 | - | - |
| V AC | - | 110 | 240 |
| mA | 360 | 50 | 65 |

Dispositivo luminoso disponibile in versione:
STEADY e **FLASHING** con lampada a incandescenza
LED con tecnologia a LED SMD
X a flash con lampada a scarica di Xenon

L'avvisatore è dotato di base per installazione retroquadro (versioni R) o con pressacavo M16 (versioni M).

Tensione operativa

OVOLUX STEADY: 12/240V ACDC +/-10% (fornito senza lampada)
OVOLUX FLASHING: 12/48V DC, 24/240V AC +/-10% (fornito senza lampada)
OVOLUX LED: 12/24V ACDC, 90/240V AC +/-10%
OVOLUX X: 24V ACDC, 110V AC, 240V AC +/-10% (fornito con lampada)

Caratteristiche meccaniche

Cupola e base in policarbonato. Fissaggio tramite anello di chiusura (versioni R), tramite viteria standard non fornita (versioni M).

Caratteristiche luminose

OVOLUX STEADY (luce fissa), **OVOLUX FLASHING** (luce lampeggiante) con lampada a incandescenza Ba15d da 5W o 10W
OVOLUX LED con tecnologia LED SMD, è possibile realizzare 4 diverse funzioni luminose tramite dip-switch (luce fissa, singolo lampeggio, doppio lampeggio, triplo lampeggio)
OVOLUX X con lampada Xenon, doppio flash 2F da 2J

Certificazioni / Certifications

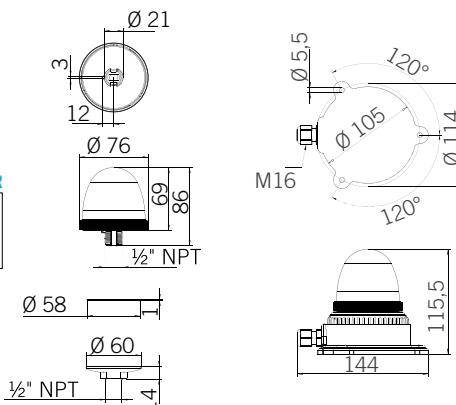
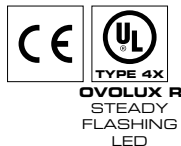

Luminous device available in different versions:
STEADY and **FLASHING** with incandescent lamp
LED with SMD LED technology
X flashing light with Xenon discharge tube.

Available with flush mounting base (R versions) or with M16 cable gland (M versions).

Voltagges

OVOLUX STEADY: 12/240V ACDC +/-10% (supplied without bulb)
OVOLUX FLASHING: 12/48V DC, 24/240V AC +/-10% (supplied without bulb)
OVOLUX LED: 12/24V ACDC, 90/240V AC +/-10%
OVOLUX X: 24V ACDC, 110V AC, 240V AC +/-10% (supplied with bulb)

Mechanical features

Polycarbonate dome and base. Mounting through the provided locking ring (R versions). Screw mounting (screws not included) for M versions.

Optical features

OVOLUX STEADY (steady light), **OVOLUX FLASHING** (flashing light) with incandescent lamp Ba15d 5W or 10W
OVOLUX LED with SMD LED technology, it is possible to select via dip-switch 4 light effects (steady light, single flash, double flash, triple-flash)
OVOLUX X with 2J Xenon discharge tube, double flash 2F



Feu de signalisation disponible en version :
STEADY et **FLASHING** avec ampoule à incandescence
LED avec technologie à LED SMD
X à éclats, avec tube à décharge au Xénon.

Le dispositif est disponible pour installation à encastrer (versions R) ou avec presse-étoupe M16 (versions M).

Tension d'utilisation

OVOLUX STEADY: 12/240V ACDC +/-10% (fourni sans ampoule)
OVOLUX FLASHING: 12/48V DC, 24/240V AC +/-10% (fourni sans ampoule)
OVOLUX LED: 12/24V ACDC, 90/240V AC +/-10%
OVOLUX X: 24V ACDC, 110V AC, 240V AC +/-10% (fourni avec ampoule)

Caractéristiques mécaniques

Base et dôme en polycarbonate. Fixation par bague de serrage (versions R), ou par vis standards non fournies (versions M).

Caractéristiques optiques

OVOLUX STEADY (feu fixe), **OVOLUX FLASHING** (feu clignotant) avec ampoule à incandescence Ba15d 5W ou 10W
OVOLUX LED avec technologie à LED SMD, on peut sélectionner par dip-switch 4 différents effets lumineux (lumière fixe, simple, double ou triple éclat)
OVOLUX X avec tube à décharge au Xénon, double éclat 2F 2J

Codici / Codes**OVOLUX STEADY***







Luce fissa con lampada a filamento
Steady light with incandescent bulb
Feu fixe, ampoule à incandescence

| |  |  |  |  |  |  |  |
|--------------|---|---|---|---|---|---|---|
| BASES | | | | | | | |
| R | 12/240V ACDC | 30011 | 30012 | 30013 | 30014 | 30015 | 30016 |
| M | 12/240V ACDC | 30031 | 30032 | 30033 | 30034 | 30035 | 30036 |

* Fornito senza lampada / Supplied without bulb / Fourni sans ampoule

OVOLUX FLASHING*







Luce lampeggiante con lampada a filamento
Flashing light with incandescent bulb
Feu clignotant avec ampoule à incandescence

| |  |  |  |  |  |  |  |
|--------------|---|---|---|---|---|---|---|
| BASES | | | | | | | |
| R | 12/48V DC | 30051 | 30052 | 30053 | 30054 | 30055 | 30056 |
| | 24/240V AC | 30091 | 30092 | 30093 | 30094 | 30095 | 30096 |
| M | 12/48V DC | 30071 | 30072 | 30073 | 30074 | 30075 | 30076 |
| | 24/240V AC | 30111 | 30112 | 30113 | 30114 | 30115 | 30116 |

* Fornito senza lampada / Supplied without bulb / Fourni sans ampoule







OVOLUX LED

Luce multifunzione a LED
LED multifunctional light
Feu multifonction à LED

| |  |  |  |  |  |  |  |
|--------------|---|---|---|---|---|---|---|
| BASES | | | | | | | |
| R | 12/24V ACDC | 38781 | 38782 | 38783 | 38784 | 38785 | 38786 |
| | 90/240V AC | 38791 | 38792 | 38793 | 38794 | 38795 | 38796 |
| M | 12/24V ACDC | 38801 | 38802 | 38803 | 38804 | 38805 | 38806 |
| | 90/240V AC | 38811 | 38812 | 38813 | 38814 | 38815 | 38816 |

OVOLUX X*

Luce allo Xenon
Flashing light with Xenon discharge tube
Feu au Xénon

| |  |  |  |  |  |  |  |
|--------------|---|---|---|---|---|---|---|
| BASES | | | | | | | |
| R | 24V ACDC | 30131 | 30132 | 30133 | 30134 | 30135 | 30136 |
| | 110V AC | 30171 | 30172 | 30173 | 30174 | 30175 | 30176 |
| | 240V AC | 30211 | 30212 | 30213 | 30214 | 30215 | 30216 |
| M | 24V ACDC | 30151 | 30152 | 30153 | 30154 | 30155 | 30156 |
| | 110V AC | 30191 | 30192 | 30193 | 30194 | 30195 | 30196 |
| | 240V AC | 30231 | 30232 | 30233 | 30234 | 30235 | 30236 |

* Fornito con lampada / Supplied with bulb / Fourni avec ampoule

RICAMBI CUPOLE / SPARE DOMES / DOMES DE RECHANGE

| |  |  |  |  |  |  |
|--|---|---|---|---|---|---|
| | 71115 | 71116 | 71117 | 71098 | 71099 | 71100 |

ACCESSORI / ACCESSORIES / ACCESSOIRES

| |  |
|-------------------------|---|
| OVOLUX MOUNTING ADAPTER | 27697 |
| WALL MOUNT | 27762 |
| DOUBLE WALL MOUNT | 27763 |
| EXTENDED FOOT L10 | 27764 |

ACCESSORI ACCESSORIES ACCESSOIRES



OVOLUX MOUNTING ADAPTER

OVOLUX MOUNTING ADAPTER

ADATTATORE (necessario per utilizzare gli accessori)
ADAPTER (to mount the accessories)
ADAPTATEUR (nécessaire pour utiliser les accessoires)

Codici / Codes

OVOLUX MOUNTING ADAPTER

27697

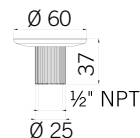

EXTENDED FOOT L10

EXTENDED FOOT L10

Base piana per montaggio superficiale con estensione di 10 cm
Flat base for surface mount with 10 cm extension
Base pour montage à plat (position soulevée de 10 cm)

Codici / Codes

EXTENDED FOOT L10

27764

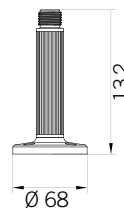

WALL MOUNT

WALL MOUNT

Base parete per montaggio laterale
Wall base for side mount
Support fixation en applique (à filetage simple)

Codici / Codes

WALL MOUNT

27762

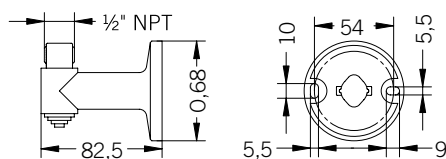

DOUBLE WALL MOUNT

DOUBLE WALL MOUNT

Base parete per montaggio laterale di 2 dispositivi
Wall base for side mount of 2 devices
Support fixation en applique (à double filetage) pour 2 dispositifs

Codici / Codes

DOUBLE WALL MOUNT

27763

