

















AS-Interface dispositivo di indirizzamento V3.0 per l'impostazione degli indirizzi di moduli slave AS-i test di ingressi/uscite e altre funzioni specifica AS-i V3.0 presa di collegamento M12 con cavo di indirizzamento 1,5 m (connettore M12 / connettore a barilotto) con batterie (4 x 1,5 V LR6)

Dati tecnici generali		
esecuzione del prodotto		Dispositivo di indirizzamento AS-Interface
altre avvertenze		temperatura di stoccaggio senza batterie
Condizioni ambientali		
temperatura ambiente		
• durante l'esercizio	°C	0 ... 55
• durante l'immagazzinaggio	°C	-20 ... +55
Dati meccanici		
larghezza	mm	84
altezza	mm	195
profondità	mm	35
Certificati/ Approvazioni		
General Product Approval		EMV
		
		
CCC	UKCA	EG-Konf.
UL		
Functional Safety	Test Certificates	Maritime application
Type Examination Certificate	Type Test Certificates/Test Report	Special Test Certificate
		
		
		
Maritime application	other	
		
LRS	PRS	RINA
		
	RMRS	产品合格 QC PASS
		Miscellaneous
other	Railway	Environment
Confirmation	Special Test Certificate	Environmental Confirmations
Miscellaneous	Type Test Certificates/Test Report	

Ulteriori informazioni

Informazioni sull'imballaggio

<https://support.industry.siemens.com/cs/ww/it/view/109813875>

Information for data generation and storage

<https://support.industry.siemens.com/cs/ww/en/view/109995012>

Information- and Downloadcenter (Cataloghi, Opuscoli,...)

<https://www.siemens.com/ic10>

Industry Mall (sistema di ordinazione Online)

<https://mall.industry.siemens.com/mall/it/it/Catalog/product?mlfb=3RK1904-2AB02>

Generatore CAx online

<https://support.automation.siemens.com/WW/CAxorder/default.aspx?lang=en&mlfb=3RK1904-2AB02>

Service&Support (Manuali, Certificati, Caratteristiche, FAQ, ...)

<https://support.industry.siemens.com/cs/ww/it/ps/3RK1904-2AB02>

Banca dati immagini (foto prodotto, disegni dimensionali 2D, modelli 3D, schemi delle connessioni, macro EPLAN...)

https://www.automation.siemens.com/bilddb/cax_de.aspx?mlfb=3RK1904-2AB02&lang=en

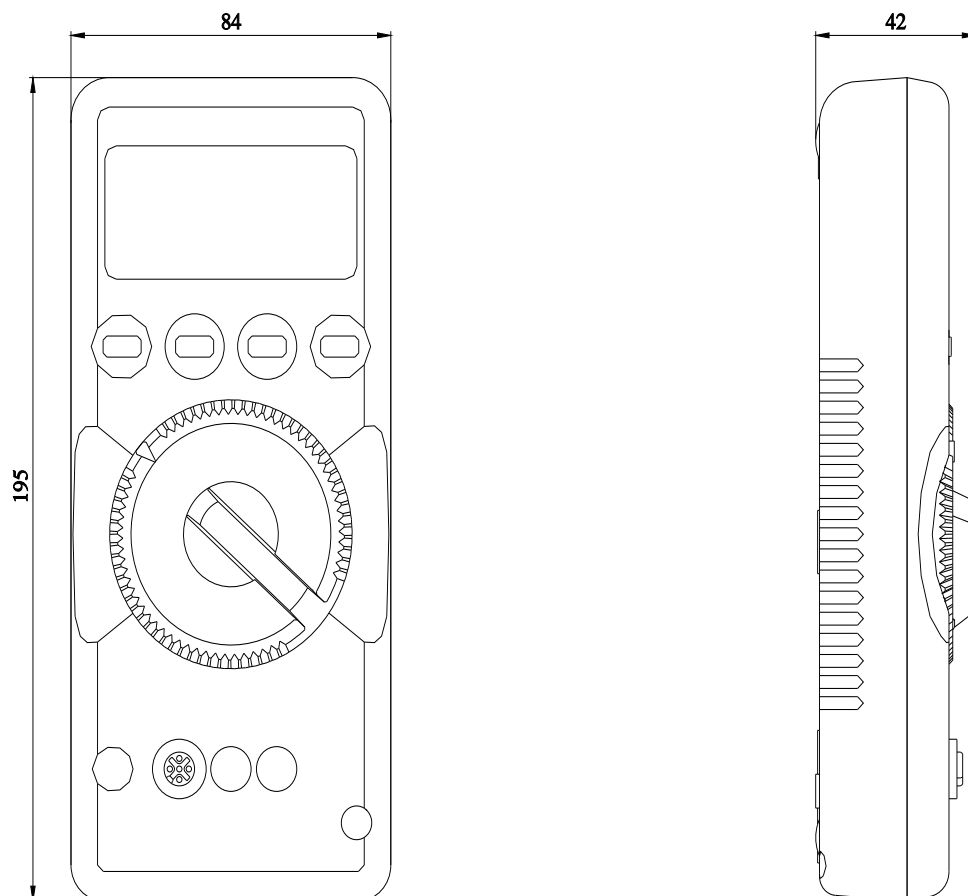

Ultima modifica:

20/11/2025 