







SENTRON, portafusibili per cartucce cilindriche, 10x38 mm, a 3 poli, In: 32 A, Un AC: 690 V, controllore d'intervento universale a LED, esecuzione compatta

Versione	
marca del prodotto	SENTRON
denominazione del prodotto	Portafusibili per cartucce cilindriche
esecuzione del prodotto	Segnalatore a LED, esecuzione compatta
Dati tecnici generali	
numero di poli	3
grandezza costruttiva della cartuccia fusibile	10 x 38 mm
Tensione di alimentazione	
tensione di impiego	
• con AC valore nominale	690 V
grado di protezione IP	IP20
Progettazione meccanica	
altezza	90 mm
larghezza	45 mm
profondità	58 mm
Peso netto per UQ	204 g
Certificati	
codice di riferimento secondo IEC 81346-2:2009	F
Approvazioni Certificati	
Environment	General Product Approval
Environmental Confirmations	   
General Product Approval	other   
Ulteriori informazioni	
Informazioni sull'imballaggio https://support.industry.siemens.com/cs/ww/it/view/109813875 Information for data generation and storage https://support.industry.siemens.com/cs/ww/en/view/109995012 Information- and Downloadcenter (Cataloghi, Opuscoli,...) https://www.siemens.com/lowvoltage/catalogs Industry Mall (sistema di ordinazione Online) https://mall.industry.siemens.com/mall/it/it/Catalog/product?mlfb=3NW7034-1 Service&Support (Manuali, Certificati, Caratteristiche, FAQ, ...) https://support.industry.siemens.com/cs/ww/it/ps/3NW7034-1 Banca dati immagini (foto prodotto, disegni dimensionali 2D, modelli 3D, schemi delle connessioni, ...) https://www.automation.siemens.com/bilddb/cax_en.aspx?mlfb=3NW7034-1 CAx-Online-Generator https://www.siemens.com/cax Tender specifications https://www.siemens.com/specifications Curve caratteristiche <a href='https://curves.simaris.siemens.com/curves/<mmp_prod_noCOMP="HAUPT"></mmp_prod_no>'>https://curves.simaris.siemens.com/curves/<mmp_prod_noCOMP="HAUPT"></mmp_prod_no>	

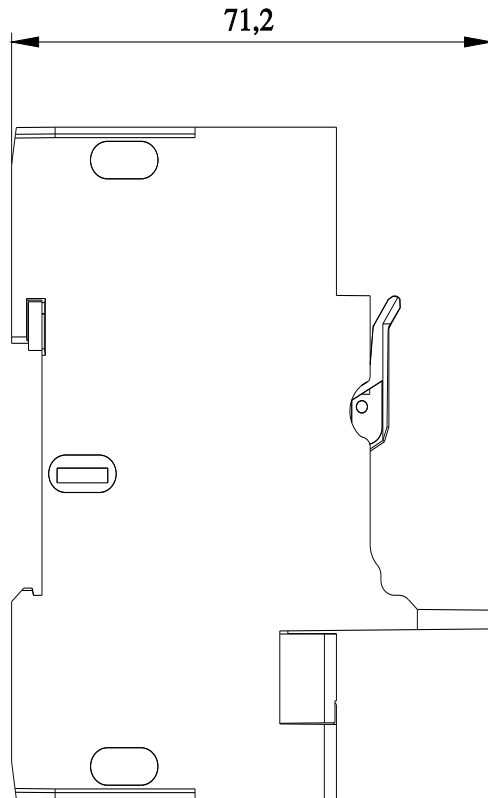
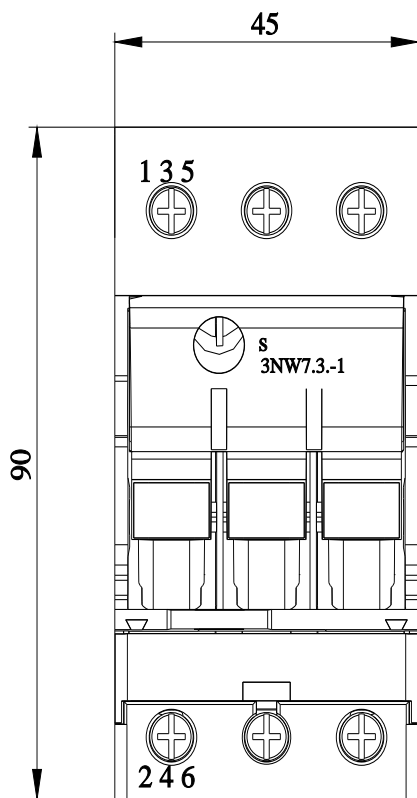

Ultima modifica:

11/04/2025

