







SENTRON, portafusibili per cartucce cilindriche, 10x38 mm, a 3 poli, In: 32 A, Un AC: 690 V, esecuzione compatta

Versione	
marca del prodotto	SENTRON
denominazione del prodotto	Portafusibili per cartucce cilindriche
esecuzione del prodotto	Esecuzione compatta
Dati tecnici generali	
numero di poli	3
grandezza costruttiva della cartuccia fusibile	10 x 38 mm
Tensione di alimentazione	
tensione di impiego	
• con AC valore nominale	690 V
grado di protezione IP	IP20
Progettazione meccanica	
altezza	90 mm
larghezza	45 mm
profondità	58 mm
Peso netto per UQ	198 g
Certificati	
codice di riferimento secondo IEC 81346-2:2009	F
Approvazioni Certificati	
Environment	General Product Approval
<a href="#">Environmental Confirmations</a>	   
General Product Approval	other
	 <a href="#">Confirmation</a>
Ulteriori informazioni	
<p>Informazioni sull'imballaggio  <a href="https://support.industry.siemens.com/cs/ww/it/view/109813875">https://support.industry.siemens.com/cs/ww/it/view/109813875</a></p> <p>Information for data generation and storage  <a href="https://support.industry.siemens.com/cs/ww/en/view/109995012">https://support.industry.siemens.com/cs/ww/en/view/109995012</a></p> <p>Information- and Downloadcenter (Cataloghi, Opuscoli,...)  <a href="https://www.siemens.com/lowvoltage/catalogs">https://www.siemens.com/lowvoltage/catalogs</a></p> <p>Industry Mall (sistema di ordinazione Online)  <a href="https://mall.industry.siemens.com/mall/it/it/Catalog/product?mlfb=3NW7033-1">https://mall.industry.siemens.com/mall/it/it/Catalog/product?mlfb=3NW7033-1</a></p> <p>Service&amp;Support (Manuali, Certificati, Caratteristiche, FAQ, ...)  <a href="https://support.industry.siemens.com/cs/ww/it/ps/3NW7033-1">https://support.industry.siemens.com/cs/ww/it/ps/3NW7033-1</a></p> <p>Banca dati immagini (foto prodotto, disegni dimensionali 2D, modelli 3D, schemi delle connessioni, ...)  <a href="https://www.automation.siemens.com/bilddb/cax_en.aspx?mlfb=3NW7033-1">https://www.automation.siemens.com/bilddb/cax_en.aspx?mlfb=3NW7033-1</a></p> <p>CAX-Online-Generator  <a href="https://www.siemens.com/cax">https://www.siemens.com/cax</a></p> <p>Tender specifications  <a href="https://www.siemens.com/specifications">https://www.siemens.com/specifications</a></p> <p>Curve caratteristiche  <a haupt"&gt;&lt;="" href="https://curves.simaris.siemens.com/curves/&lt;mmp_prod_noCOMP=" mmp_prod_no&gt;"="">https://curves.simaris.siemens.com/curves/&lt;mmp_prod_noCOMP="HAUPT"&gt;&lt;/mmp_prod_no&gt;</a></p>	

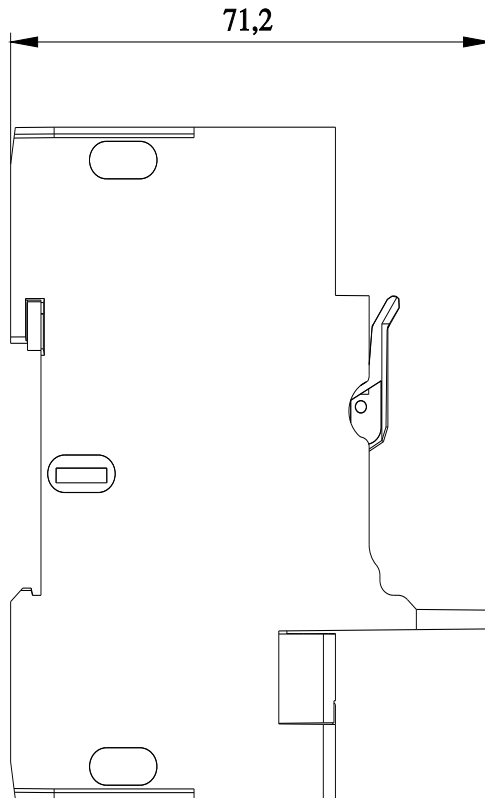
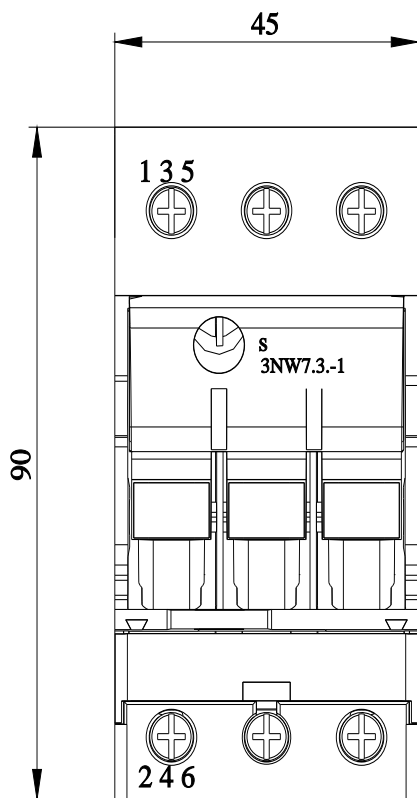

Ultima modifica:

11/04/2025

