

piastra di isolamento allungata a 4 poli, 1 pezzo accessori per: 3VA12



Versione	
marca del prodotto	SETRON
denominazione del prodotto	piastra di isolamento allungata
esecuzione del prodotto	tecnica di collegamento
accessori	piastra d'isolamento
Progettazione meccanica	
Peso netto per UQ	44 g
Certificati	
General Product Approval	EMV

[Miscellaneous](#)



[Confirmation](#)



Test Certificates	Maritime application	other	Environment		
Type Test Certificates/Test Report		Miscellaneous	Confirmation	Environmental Confirmations	Environmental Confirmations

Ulteriori informazioni

Informazioni sull'imballaggio

<https://support.industry.siemens.com/cs/ww/it/view/109813875>

Information for data generation and storage

<https://support.industry.siemens.com/cs/ww/en/view/109995012>

Information- and Downloadcenter (Cataloghi, Opuscoli,...)

<https://www.siemens.com/lowvoltage/catalogs>

Industry Mall (sistema di ordinazione Online)

<https://mall.industry.siemens.com/mall/it/it/Catalog/product?mlfb=3VA9211-0WJ40>

Service&Support (Manuali, Certificati, Caratteristiche, FAQ, ...)

<https://support.industry.siemens.com/cs/ww/it/ps/3VA9211-0WJ40>

Banca dati immagini (foto prodotto, disegni dimensionali 2D, modelli 3D, schemi delle connessioni, ...)

https://www.automation.siemens.com/bilddb/cax_en.aspx?mlfb=3VA9211-0WJ40

CAX-Online-Generator

<https://www.siemens.com/cax>

Tender specifications

<https://www.siemens.com/specifications>

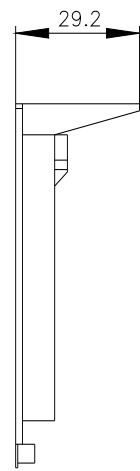
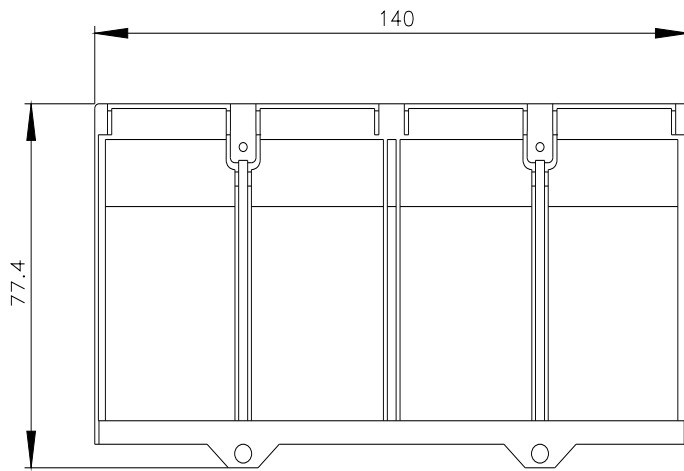

Ultima modifica:

06/04/2026 

