







Morsetto tripla 3x 2,5 - 16 mm<sup>2</sup>, per grandezza costruttiva NH000, NH00 con morsetto serracavo, accessori per sezionatori sottocarico a fusibili 3NP1 contiene 3 morsetti

Versione	
marca del prodotto	SETRON
denominazione del prodotto	Morsetto tripla 3 x 2,5 ... 16 mm <sup>2</sup>
esecuzione del prodotto	accessori per sezionatori sottocarico a fusibili 3NP1
idoneità all'impiego	per 3NP1, a 3 poli, NH000, NH00, con morsetti serracavo
Accessori	
accessori	per grandezza costruttiva NH000, NH00 con morsetto serracavo
Progettazione meccanica	
Peso netto per UQ	131 g
Approvazioni Certificati	
Environment	General Product Approval
<a href="#">Environmental Confirmations</a>	<a href="#">Environmental Confirmations</a>
	<a href="#">Miscellaneous</a>
	
	
General Product Approval	Test Certificates
	Maritime application
	other
	<a href="#">Type Test Certificates/Test Report</a>
	
	<a href="#">Confirmation</a>
	

### Ulteriori informazioni

#### Informazioni sull'imballaggio

<https://support.industry.siemens.com/cs/ww/it/view/109813875>

#### Information for data generation and storage

<https://support.industry.siemens.com/cs/ww/en/view/109995012>

#### Information- and Downloadcenter (Cataloghi, Opuscoli,...)

<https://www.siemens.com/lowvoltage/catalogs>

#### Industry Mall (sistema di ordinazione Online)

<https://mall.industry.siemens.com/mall/it/it/Catalog/product?mlfb=3NP1923-1BE20>

#### Service&Support (Manuali, Certificati, Caratteristiche, FAQ, ...)

<https://support.industry.siemens.com/cs/ww/it/ps/3NP1923-1BE20>

#### Banca dati immagini (foto prodotto, disegni dimensionali 2D, modelli 3D, schemi delle connessioni, ...)

[https://www.automation.siemens.com/bilddb/cax\\_en.aspx?mlfb=3NP1923-1BE20](https://www.automation.siemens.com/bilddb/cax_en.aspx?mlfb=3NP1923-1BE20)

#### CAX-Online-Generator

<https://www.siemens.com/cax>

#### Tender specifications

<https://www.siemens.com/specifications>

#### Curve caratteristiche

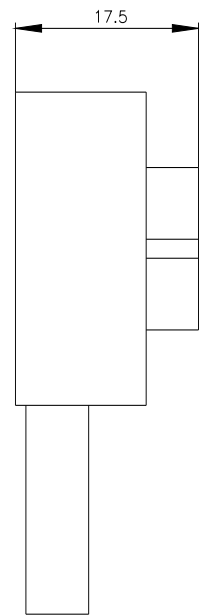
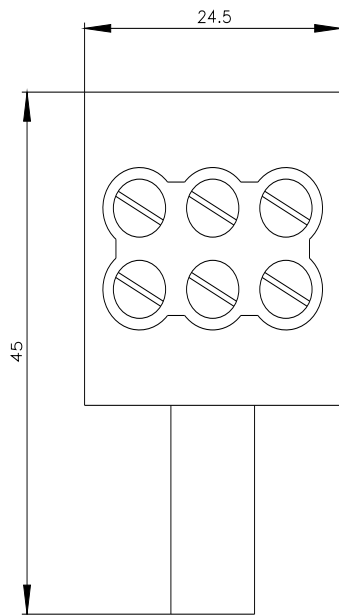

---

Ultima modifica:

12/04/2025 

