



PrismaSeT 6300

Catalog 2025
Cubicles up to 6300 A

Version 05



se.com

Life Is On



Content PrismaSeT 6300

Index
p. A-2

Catalog number index
> p A-2

Overview
p. B-1

Overview
> p B-1

Standards and
Certifications
p. C-1

Standards and tested switchboards
> p. C-2

Selection Guide
p. D-1

Select a cubicle configuration
> p D-2

Functional Units
p. E-1

Circuit breakers
> p. E-3



Enclosures
p. F-1

Enclosures
> p. F-2



Dimensions
> p. F-10



Linery Distribution
Systems
p. G-1

Power busbars
> p. G-2



Functionnal
Partitioning
p. H-1

Form partitioning
> p. H-3



Additional
Information
p. I-1



Index
p. A-2

A

Overview
p. B-1

B

Standards and
Certifications
p. C-1

C

Selection Guide
p. D-1

D

Functional Units
p. E-1

E

Enclosures
p. F-1

F

Linery Distribution
Systems
p. G-1

G

Functionnal Partitioning
p. H-1

H

Additional Information
p. I-1

I



Index Of Commercial References With Description

Com. no.	Description	Page	Com. no.	Description	Page
87233	MTZ3 40-63 Connectors	E-3, E-4, E-5	LVS04631	PrismaSeT 6300 5xCross Bar Support W1200	D-2, E-3, F-14
LVMZ1207	KT 6300A 3P Interface	D-2, E-4	LVS04639	Linery Vertical Connection Link 2500A	G-4
LVMZ1208	KT 6300A 4P Interface	D-2	LVS04646	Additional mounting hardware for supports linery lgye 3200 & 4000A	G-3
LVS01130	Linery LGYE busbar screw plate kit	G-6	LVS04648	Linery Vertical Bottom Support	G-4
LVS03509	PrismaSeT 6300 MTZ3 CB Mounting Plate	D-2, E-3, E-4, E-5	LVS04649	LGYE lateral JdB fixed support, center distance 115mm, width 300mm, depth 800mm	G-4
LVS03583	6 UNIVERSAL ANGLE BRACKETS	H-6	LVS04654	Linery Lateral Fixed Support	G-4
LVS03589	PrismaSeT 6300 2xInter Upright W1200	D-3, F-4, F-8, F-14	LVS04655	Linery Bottom Fixed Support	G-4
LVS03591	PrismaSeT 6300 2xLateral Upright W1200	F-4, F-8	LVS04658	12 chock for Linery LGYE 1600 A vert.	G-4
LVS03598	PrismaSeT 6300 2xIP Flange Cover W500	D-3, F-4, F-8	LVS04659	12 chock for Linery LGYE 4000 A vert.	G-4
LVS03599	PrismaSeT 6300 2xIP Flange Cover W1200	D-3, F-4, F-8	LVS04660	Linery Fixed Support HBB LGYE 6300A	G-2, G-3
LVS03706	PrismaSeT 6300 Front Plate 4M W1200		LVS04662	Free support for vertical/horizontal busbar Linery bs 5/10 mm or Linery lgye	G-3
LVS03707	PrismaSeT 6300 Front Plate 11M W1200	D-2, E-3, E-4, E-5	LVS04664	Horizontal fixed busbar support for Linery BS 5/10 mm or linery lgye	G-3
LVS03708	PrismaSeT 6300 FP MTZ3 10M W1200	D-2, E-3, E-4, E-5	LVS04671	Support mounting hardware for bars > 80 mm	G-3
LVS04229	Voltage tap-offs for tab connectors, M10 (20)	G-6	LVS04675	Linery Free Support HBB LGYE 6300A	G-2, G-3
LVS04509	Linery LGYE vertical busbar, 3200 A	G-4	LVS04678	Free 5/10 busbar support D600 Linery bs	D-2, E-3, E-4, E-5, G-4
LVS04510	Linery LGYE vertical busbar, 4000 A	G-4	LVS04739	PrismaSeT 6300 Canalis Conn Pad MTZ3	E-4
LVS04560	Linery LGYE horiz. busbar 630 A	G-2, G-4	LVS04742	Insulated flex.Bar 20 x2 L1800	G-7
LVS04561	Linery LGYE horiz. busbar 800 A	G-2, G-4	LVS04743	Insulated flex.bar 20 x3 L1800	G-7
LVS04562	Linery LGYE horiz. busbar 1000 A	G-2, G-4	LVS04746	Insulated flex.bar 24 x5 L1800	G-7
LVS04563	Linery LGYE horiz. busbar 1250 A	G-2, G-4	LVS04751	Insulated flex.bar 32 x5 L1800	G-7
LVS04564	Linery LGYE horiz. busbar 1600 A	G-2, G-4	LVS04752	Insulated flex.bar 32 x6 L1800	G-7
LVS04565	Linery LGYE horiz. busbar 2000 A	G-2, G-4	LVS04753	Insulated flex.bar 32 x8 L1800	G-7
LVS04566	Linery LGYE horiz. busbar 2500 A	G-2, G-4	LVS04759	Torque nuts, M8 (20)	G-6
LVS04567	Linery LGYE horiz. busbar 3200 A	G-2	LVS04766	20 M8 LGY bolts for cab.lug/ flex bar L25	G-6
LVS04568	Linery LGYE horiz. busbar 4000 A	G-2	LVS04767	20 M8 LGY bolts for copper bar L39	G-6
LVS04569	Linery Profile HBB LGYE 6300A L960	G-2	LVS04768	SET OF 12 screwplates for linery evolution 2500A	G-6
LVS04580	Linery Profile HBB LGYE 6300A L1160	G-2	LVS04769	SET OF 8 screwplates for linery evolution 4000A	G-6
LVS04581	Linery Profile HBB LGYE 6300A L1360	G-2	LVS04773	M8 washers for insulated flexible bars (20), external diameter 24 mm	G-6
LVS04582	Linery Profile HBB LGYE 6300A L1690	G-2, G-4	LVS04774	M8 washers for insulated flexible bars (20), external diameter 28 mm	G-6
LVS04604	Linery LGYE vert. short connection 2500 A	G-4	LVS04775	M8 conducting washers for lugs = 25 mm (20), external diameter 20 mm	G-6
LVS04605	Connection, Linery LGY, for vertical long connection 2500A	G-4	LVS04782	Bolts for bars (20), M8x20	G-6
LVS04620	Linery LGYE horiz. connection 1600 A	G-3	LVS04783	Bolts for bars (20), M8x25	G-6
LVS04621	Linery LGYE horiz. connection 2500 A	G-3	LVS04784	Bolts for bars (20), M8x30	G-6
LVS04622	Linery Vertical Connection Link 3200A	G-4	LVS04785	Bolts for bars (20), M8x35	G-6
LVS04623	Linery Evol. horiz. connection 4000 A	G-3	LVS04786	Bolts for bars (20), M8x40	G-6
LVS04624	Isolating screen neutral Linery LGYE	G-3			
LVS04625	Linery Fish Plate for 2xHBB LGYE 6300 A	G-3			
LVS04627	Linery Vertical Links+Inserts LGYE 6300 A	G-4			



Index Of Commercial References With Description

Com. no.	Description	Page	Com. no.	Description	Page
LVS04787	Bolts for bars (20), M8 x 45	G-6	NSY2SP208ED	External fixing side panels, PrismaSeT, for enclosure H 2000 x W 800 mm, RAL 9003, set of 2	F-2
LVS04788	Bolts for bars (20), M8 x 50	G-6	NSY2SPN205	PanelSeT SFN external fixing side panels - 2000x500 mm	F-9
LVS04794	Linery markers (12)	G-6	NSY2SPN208	PanelSeT SFN external fixing side panels - 2000x800 mm	F-6
LVS04901	Form 3 horizontal partition	H-6	NSY2SPN208ED	PrismaSeT 6300 - 2 side panels - 2000x800 mm - RAL9003	F-2, F-5
LVS04911	Inter cubicle partition, PrismaSeT P, 2 panels H 850mm W 320mm, for 2 adjacent cubicles D400 / D600	H-4	NSYCAC228RMB	Roof outlet grille - cut-out 228x228mm - ext. dim 90x340x340mm - IP54, white (RAL 9003)	F-17
LVS04924	Form 2 restoration kit for side barrier cut-out	H-4	NSYCAC228RMF	Roof outlet grille - cut-out 228x228mm - ext. dim 90x340x340mm - IP54, grey	F-17
LVS04943	F3 PARTITION REAR SUPPORT	H-6	NSYCAF291	Filter STD G2 cut-out. 291 x 291 mm	F-16
LVS04946	F4 backplate front conn. D600	H-7	NSYCAF291T	Fine filter G3 for outlet grille or fan cut-out 291 x 29 mm 1 ext. dim 336 x 316 mm	F-16
LVS04951	Gland plate, PrismaSeT P, H 200mm W 325mm, lateral or rear mounting in form 4 partitioning	H-7	NSYCAC228RMB	Roof outlet grille - cut-out 228x228mm - ext. dim 90x340x340mm - IP54, white (RAL 9003)	F-17
LVS04952	Gland plate, PrismaSeT P, H 300mm W 325mm, lateral or rear mounting in form 4 partitioning	H-7	NSYCAF291T	Fine filter G3 for outlet grille or fan cut-out 291 x 29 mm 1 ext. dim 336 x 316 mm	F-16
LVS04969	PrismaSeT 6300 Covers HZ F2 7M BB W300	H-5	NSYCAC228RMF	Roof outlet grille - cut-out 228x228mm - ext. dim 90x340x340mm - IP54, grey	F-17
LVS04970	PrismaSeT 6300 Covers HZ F2 7M BB W500	H-5	NSYCAF291	Filter STD G2 cut-out. 291 x 291 mm	F-16
LVS04971	PrismaSeT 6300 Covers HZ F2 7M BB W700	H-5	NSYCAF291T	Fine filter G3 for outlet grille or fan cut-out 291 x 29 mm 1 ext. dim 336 x 316 mm	F-16
LVS04972	PrismaSeT 6300 Covers HZ F2 7M BB W1200	H-5	NSYCAC228RMB	Roof outlet grille - cut-out 228x228mm - ext. dim 90x340x340mm - IP54, white (RAL 9003)	F-17
LVS04979	PrismaSeT 6300 1xSet Side Partition D800	F-9, H-4	NSYCAC228RMF	Roof outlet grille - cut-out 228x228mm - ext. dim 90x340x340mm - IP54, grey	F-17
LVS04990	PrismaSeT 6300 F-B Barrier Form 2 W500	H-4	NSYCAF291	Filter STD G2 cut-out. 291 x 291 mm	F-16
LVS06500	Cross Brackets Upright & Intern Plates	F-4, F-8	NSYCAF291T	Fine filter G3 for outlet grille or fan cut-out 291 x 29 mm 1 ext. dim 336 x 316 mm	F-16
LVS06540	PrismaSeT 6300 F-B Barrier Form 2 W300	H-4	NSYCAC228RMB	Roof outlet grille - cut-out 228x228mm - ext. dim 90x340x340mm - IP54, white (RAL 9003)	F-17
LVS06543	PrismaSeT 6300 Side Barrier Form 2 D800	H-4	NSYCAC228RMF	Roof outlet grille - cut-out 228x228mm - ext. dim 90x340x340mm - IP54, grey	F-17
LVS06545	PrismaSeT 6300 Side Barrier Form 2 D500	H-4	NSYCAF291	Filter STD G2 cut-out. 291 x 291 mm	F-16
LVS06555	PrismaSeT 6300 Inter Cubicle Cover D500	H-4	NSYCAF291T	Fine filter G3 for outlet grille or fan cut-out 291 x 29 mm 1 ext. dim 336 x 316 mm	F-16
LVS06560	PrismaSeT 6300 HZ Cover F2 W300 D500	H-5	NSYCAC228RMB	Roof outlet grille - cut-out 228x228mm - ext. dim 90x340x340mm - IP54, white (RAL 9003)	F-17
LVS06563	PrismaSeT 6300 HZ Cover F2 W300 D500+300	H-5	NSYCAC228RMF	Roof outlet grille - cut-out 228x228mm - ext. dim 90x340x340mm - IP54, grey	F-17
LVS06567	PrismaSeT 6300 4M HZ Cover F2 W700	H-5	NSYCAF291	Filter STD G2 cut-out. 291 x 291 mm	F-16
LVS06568	PrismaSeT 6300 4M HZ Cov F2 W300D500+300	H-5	NSYCAF291T	Fine filter G3 for outlet grille or fan cut-out 291 x 29 mm 1 ext. dim 336 x 316 mm	F-16
LVS06569	PrismaSeT 6300 Mounting Flange Cov W700	D-3, F-4, F-8	NSYCAC228RMB	Roof outlet grille - cut-out 228x228mm - ext. dim 90x340x340mm - IP54, white (RAL 9003)	F-17
LVS06570	PrismaSeT 6300 HZ Cover F2 W700 D500	H-5	NSYCAC228RMF	Roof outlet grille - cut-out 228x228mm - ext. dim 90x340x340mm - IP54, grey	F-17
LVS06600	PrismaSeT 6300 Form 4 FU 3 to 5MOD	H-7	NSYCAF291	Filter STD G2 cut-out. 291 x 291 mm	F-16
LVS06601	PrismaSeT 6300 Form 4 FU 4 to 6 MOD	H-7	NSYCAF291T	Fine filter G3 for outlet grille or fan cut-out 291 x 29 mm 1 ext. dim 336 x 316 mm	F-16
LVS06604	PrismaSeT 6300 Form 4 Conn Trans 3P 630A	H-7	NSYCAC228RMB	Roof outlet grille - cut-out 228x228mm - ext. dim 90x340x340mm - IP54, white (RAL 9003)	F-17
LVS06605	PrismaSeT 6300 Form 4 Conn Trans 4P 630A	H-7	NSYCAC228RMF	Roof outlet grille - cut-out 228x228mm - ext. dim 90x340x340mm - IP54, grey	F-17
LVS06606	PrismaSeT 6300 Form 4 Conn Trans 3P 250A	H-7	NSYCAF291	Filter STD G2 cut-out. 291 x 291 mm	F-16
LVS06607	PrismaSeT 6300 Form 4 Conn Trans 4P 250A	H-7	NSYCAF291T	Fine filter G3 for outlet grille or fan cut-out 291 x 29 mm 1 ext. dim 336 x 316 mm	F-16
LVS08566	HINGED FR.PLATE SUPFRAME W650	F-4, F-8	NSYCAC228RMB	Roof outlet grille - cut-out 228x228mm - ext. dim 90x340x340mm - IP54, white (RAL 9003)	F-17
LVS08921	20 framework screws + wing nuts	F-12	NSYCAC228RMF	Roof outlet grille - cut-out 228x228mm - ext. dim 90x340x340mm - IP54, grey	F-17



Index Of Commercial References With Description

Com. no.	Description	Page	Com. no.	Description	Page
NSYINT71	Shape insert - lock 7 mm triangular insert	F-18	NSYSFP12200	PanelSeT SFN/SM front plinth - 200x1200 mm	F-2, F-6, F-13
NSYINT81	Shape insert - lock 8 mm triangular insert	F-18	NSYSFPS8100	PanelSeT SFN/SM side panel plinth - 100x800 mm	F-13
NSYINT91	Shape insert - lock 9 mm triangular insert	F-18	NSYSFPS8200	PanelSeT SFN/SM side panel plinth - 200x800 mm	F-2, F-3, F-6, F-7, F-13
NSYSFBK19	PanelSeT SFN coupling kit for SFN enclosures equipped with swinging 19" rack - IP55	F-12	NSYSUCR6580	Busbar free support, Linergy BS, 115mm between centers, for 5-10mm thick busbar	D-2, E-3, E-4, E-5, G-3
NSYSFN20380	PanelSeT SFN enclosure without mounting plate - assembled - 2000x300x800 mm	F-7, F-8	NSYSUCR9080	PanelSeT SFN/SM universal cross rails -	D-2, E-3, E-4, E-5
NSYSFN20380ED	PrismaSeT 6300 - Enclosure busbar/cables - plain door - 2000x300x800 - RAL9003	D-3, F-3, F-4	NSYSUCR40120	PanelSeT SFN/SM universal cross rails -	D-2, E-3
NSYSFN20580	PanelSeT SFN enclosure without mounting plate - assembled - 2000x500x800 mm	F-7, F-8	NSYSUCR40200	PanelSeT SFN/SM universal cross rails - 40 mm	D-3, F-4, F-8
NSYSFN20580ED	PrismaSeT 6300 - Enclosure LGYE6300 busbar - plain door - 2000x500x800 - RAL9003	D-3, F-3, F-4	NSYSUCR65120	Universal cross rails, PanelSeT SFN, Spacial SF, Spacial SM, H65 W1200mm, 2 rows, set of 2	D-2, E-3, E-4, E-5
NSYSFN201280DED	PrismaSeT 6300 - Enclosure for MTZ3 - double door - 2000x1200x800mm - RAL9003	D-3, F-2, F-4	NSYSUCR90120	PanelSeT SFN/SM universal cross rails -	D-2, E-3
NSYSFN2012802D	PanelSeT SFN enclosure without mounting plate - assembled - 2000x1200x800 mm	F-6, F-8	NSYVR18	Spacial SM/SF - set of 2 standard spars L1696mm - for enclosures H1800mm	F-4, F-8
NSYSFNHS1	PanelSeT SFN/SM handle for shape inserts and cylindrical barrels	F-18			
NSYSFPAED	Adaptation uprights for Linergy LGY supports installation	D-3, F-4			
NSYSFPN20780ED	PrismaSeT 6300 - Enclosure PrismaSeT FU - plain door - 2000x700x800 mm - RAL9003	D-3, F-2, F-4			
NSYSFPN20780G	PrismaSeT 6300 - Enclosure PrismaSeT FU - plain door - 2000x700x800 mm - RAL7035	F-6			
NSYSFPN20780TED	PrismaSeT 6300 - Enclosure PrismaSeT FU - transp. door - 2000x700x800 mm - RAL9003	D-3, F-4			
NSYSFPN20780TG	PrismaSeT 6300 - Enclosure PrismaSeT FU - transp. door - 2000x700x800 mm - RAL7035	F-8			
NSYSFSEGS300	PrismaSeT 6300 - SE Green signature for W300 RAL 7035 enclosures	I-2			
NSYSFSEGS500	PrismaSeT 6300 - SE Green signature for W500 RAL 7035 enclosures	I-2			
NSYSFSEGS700	PrismaSeT 6300 - SE Green signature for W700 RAL 7035 enclosures	I-2			
NSYSFSEGS1200	PrismaSeT 6300 - SE Green signature for W1200 RAL 7035 enclosures	I-2			
NSYSFTB16	Set of 4 PanelSeT SFN M12 lifting eyebolt - galvanized cast steel	F-15			
NSYSFPF3100	PanelSeT SFN front plinth - 100x300 mm	F-13			
NSYSFPF3200	PanelSeT SFN front plinth - 200x300 mm	F-3, F-7, F-13			
NSYSFPF5100	PanelSeT SFN front plinth - 100x500 mm	F-13			
NSYSFPF5200	PanelSeT SFN front plinth - 200x500 mm	F-3, F-7, F-13			
NSYSFPF7100	PanelSeT SFN front plinth - 100x700 mm	F-13			
NSYSFPF7200	PanelSeT SFN front plinth - 200x700 mm	F-2, F-6, F-13			
NSYSFPF12100	PanelSeT SFN/SM front plinth - 100x1200 mm	F-13			





Overview

PrismaSeT

B-2

PrismaSeT - Reliable, Easily connected	B-2
Wireless Sensor for Early Detection of Overheating Cables	B-3
PrismaSeT G: Enclosures up to 630A - IP30, IP40, IP41, IP43, IP55	B-4
PrismaSeT P: Cubicles up to 4000A IP30, IP31, IP55	B-5
PrismaSeT 6300: Electrical switchboards from 4000 A up to 6300 A	B-6
The switchboard, central to the electrical installation	B-8
Minimum Distance Around the Switchboard	B-9

B



PrismaSeT - Reliable, Easily connected

The new PrismaSeT switchboard is the market forerunner with built-in cloud connectivity, allowing instant access to smart alarm system, energy usage analysis, trends, and preventative maintenance plans.

Built-in cloud connectivity allows users to be notified of the round-the-clock electrical distribution as well as voltage loss if any. This maximizes efficiency and power availability, while creating the basis for future innovations. The PrismaSeT switchboard also allows easy wireless integration of sensors.

PowerLogic HeatTag

- Cable Overheating Alert



The PowerLogic HeatTag sensor is a revolutionary new product designed for fire prevention in switchboards. It uses proactive heating detection technology to drastically reduce the risk of fire.

ComPacT NSX

- With wireless Auxiliary Contact



New ComPacT NSX circuit breaker redefines and enhances customer experience through seamless connectivity along with game-changing user interface.

Acti9 AFDD Connect

- Arc Fault detection on Load cables



Acti9 AFDD Connect is most advanced protection available with all-in-one function providing connectivity and diagnostics.

PowerLogic PowerTag

- From 1 to 6300 A



PowerTag Energy is a wireless communication energy sensor that provides precise, real-time data on energy, currents, power, voltage, and power factor.



Wireless Sensor for Early Detection of Overheating Cables



SMT10020

HeatTag is a smart sensor for early detection of overheating wire connections or overheating cables. HeatTag helps prevent electrical switchboards from being damaged, by analyzing gas and particles in the air and sending alerts before any smoke or insulator browning.

Standards

The HeatTag smart sensor complies with the following standards:

- IEC 61010-1:2017 UL/CSA/EU CENELEC deviations
- IEC/EN 61326-1b FCC Part 15B and 15C
- ETSI/EN 300328
- ETSI/EN 301489-1
- IEEE 802.15.4

Note:

Do not use HeatTag as a safety device. HeatTag does not replace the fire protection devices of the building.

Presentation

HeatTag smart sensor:

- Sends three levels of alert depending on the severity of the situation it detects.
- Helps prevent potential fire damages by analyzing gas and micro-particles emitted by cable sheaths when overheating.
- Measures temperature and humidity.
- Communicates with all Schneider Electric EcoStruxure panel servers or gateways.
- Is integrated in EcoStruxure solutions.

The HeatTag sensor must be installed only in non-forced air ventilated switchboards. It must be mounted on a DIN rail.

During the first 30 minutes after commissioning, HeatTag can generate an alert for test. It then takes another 8 hours for HeatTag to define its nominal environment and to be fully operational. Each time the HeatTag sensor is powered on, these 30-minute and 8-hour sequences are repeated.

Operation

Paired with Schneider Electric panel servers or gateways, HeatTag reports:

- Alerts
- Air quality index
- Temperature and humidity measurement
- Self-diagnosis information

Air Quality

HeatTag provides an air quality index, ranging from 0 to 10, and displays the air quality evolution trend in a table.

When the air quality index is equal or above 10, HeatTag sends an alert. It has detected abnormal cable sheath heating in the switchboard.

Detection Alert

An alert is triggered when HeatTag detects abnormal cable sheath heating in the switchboard, which can be caused by:

- One or more loose connections (too high contact resistance)
- A poorly sized cable compared to the rated current
- Overcurrent and poorly regulated protective equipment
- Alerts are triggered with three severity levels:
- Low level: a cable is slowly overheating in the installation, you must plan a maintenance visit of the installation.
- Medium level: a cable is overheating in the installation, you must go quickly to the installation for maintenance.
- High level: a cable overheats very quickly, you must check the installation immediately.
- The orange application led flashes when HeatTag sends an alert to the panel servers or gateways.

Temperature

HeatTag provides a temperature value with a 30 second default transmission period. The transmission period can be increased by the system in case of high wireless data traffic.

Humidity

The HeatTag provides a humidity rate with a 30 second default transmission period. The transmission period can be increased by the system in case of high wireless data traffic.

Self-Diagnosis

HeatTag carries out two types of diagnosis:

- A minor alert is sent when the fan rpm is 80% of its nominal rpm, which means fan clogging.
- A major alert is sent when HeatTag is faulty. In this case it cannot report measures at all, nor reports incorrect measures.



PrismaSeT G: Enclosures up to 630 A IP30, IP40, IP41, IP43, IP55



160 A

250 A

630 A

- Schools
- Small shops
- Hotels, etc.

Pack 250



- Small companies
- Buildings
- Offices
- Laboratories
- Healthcare centres
- Hotels
- Supermarkets
- Malls, etc.

PrismaSeT G



PrismaSeT P: Cubicles up to 4000 A IP30, IP31, IP55

The optimised, tested and IEC compliant solution, for low voltage electrical distribution and control switchboards.



B



- Hospitals
- Data centres
- Logistics centres
- Shopping centres
- Offices buildings

PrismaSeT P



Energy management has never been simpler

Smart Panels connect you to energy savings in three steps.

1. Measure

Embedded and stand-alone metering & control capabilities

- Embedded and stand-alone metering
- Control capabilities

2. Connect

- Integrated communication interfaces
- Ready to connect to energy management platforms

3. Act

- Data-driven energy efficiency actions
- Real time monitoring and control
- Access to energy and site information through on-line services



Tested, Validated, Documented Smart Panels architecture
 Smart Panels have been certified via Schneider Electric's "TVDA" quality process
 Tested in performance labs by experts, in the most common configuration
 Validated full functional compatibility of devices
 Documented, with user guide, predefined CAD panel designs & wiring diagrams



PrismaSeT 6300: Electrical switchboards from 4000 A...

The PrismaSeT 6300 functional system can be used for all types of low-voltage distribution switchboards up to 6300 A in harsh environments.

PB603874.ai

PB603877(2).ai



Switchboard design is very simple

1. A metal structure

Made up of one or more pre-assembled frameworks combined side-by-side or back-to-back.

2. A distribution system

Horizontal busbars running on the top or bottom and vertical busbars positioned in a lateral compartment or at the rear of the cubicle are used to distribute electricity throughout the switchboard.

3. Complete functional units

- dedicated mounting plate for device installation
- front plate to block direct access to live parts.
- devices for on-site connections.

Each functional unit contributes to a function in the switchboard.

The functional units are modular and are arranged rationally.

The system includes everything required for functional unit mounting, supply and onsite connection.

The components of the PrismaSeT 6300 and those of the functional units in particular have been designed and tested taking into account device characteristics.

This design approach ensures a high degree of reliability in system operation and optimum safety for personnel.



Advantages of PrismaSeT 6300 system switchboards

1. A dependable electrical installation

The total compatibility of Schneider Electric devices with the PrismaSeT 6300 system is a key advantage in ensuring a high level of installation dependability.

2. An upgradeable electrical installation

Thanks to modular design, PrismaSeT 6300 switchboards can be modified easily to integrate new functional units as needed or to be combined with the PanelSeT SFN Control Panel cabinets.

3. Total safety for personnel

Work in a switchboard must be carried out by authorised persons in compliance with all applicable safety regulations.

To increase the safety of personnel, devices are installed behind protective front plates; only the operating handles are accessible.

Additional internal protection (partitions, barriers) is available to create form 2, 3 or 4 separation to protect against direct contacts with live parts.

Terminal shields are mandatory for installation of Compact NSX and INS/INV devices in PrismaSeT 6300 enclosures.

4. Connected solution up 4000 A

- Fire prevention
- Power availability
- Energy management



...up to 6300 A

Use of the components in the PrismaSeT 6300 functional system ensures the creation of switchboards complying with standard IEC 61439-1&2.



B

Electrical characteristics

- Rated insulation level of main busbars: 1000 V
- Rated operational current I_e : 6300 A
- Rated peak withstand current I_{pk} : 220 kA
- Rated short-time withstand current I_{cw} : 100 kA rms/1 second
- Frequency: 50/60 Hz.

Mechanical characteristics

- Steel sheet metal.
- Structured finish.
- 2 options:
 - Grey color RAL 7035 and white color RAL 9003 inside (for the PrismaSeT references)
 - White color RAL 9003 outside and inside.
- Can be dismantled.
- Can be combined side-by-side and back-to-back.
- Degree of protection.
- Degree of protection against mechanical impacts.
- Enclosures dimensions:
 - four widths:
 - W300 and W500: busbar or cable compartment
 - W700 and W1200: device compartment
 - one depth:
 - D800: front connection up to 6300 A
 - height: 2000 mm
- Indoor cubicles.



Electrical switchboards built using the PrismaSeT functional system and Schneider Electric recommendations fully comply with international standard IEC 61439-1 and 2.



The switchboard, central to the electrical installation

Both the point of arrival of energy and a device for distribution to the site applications, the LV switchboard is the intelligence of the system, central to the electrical installation.

It plays an essential role in the availability of electric power, while meeting the needs of personal and property safety. Its definition, design and installation are based on precise rules; there is no place for improvisation. The IEC 61439 standard aims to better define "low-voltage switchgear and controlgear assemblies", ensuring that the specified performances are reached. It specifies in particular:

- the responsibilities of each player, distinguishing those of the original equipment manufacturer; the organization that performed the original design and associated verification of an assembly in accordance with the standard, and of the assembly manufacturer - the organization taking responsibility for the finished assembly;
- the design and verification rules, constituting a benchmark for product certification.

All the component parts of the electrical switchboard are concerned by the IEC 61439 standard. Equipment produced in accordance with the requirements of this switchboard standard ensures the safety and reliability of the installation.

A switchboard must comply with the requirements of standard IEC 61439-1 and 2 to guarantee the safety and reliability of the installation. Managers of installations, fully aware of the professional and legal liabilities weighing on their company and on themselves, demand a high level of safety for the electrical installation.

What is more, the serious economic consequences of prolonged halts in production mean that the electrical switchboard must provide excellent continuity of service, whatever the operating conditions.

The Schneider Electric solution

- Specify switchboards that comply with standard IEC 61439-1 and 2.
- Guarantee a level of safety that has been 100 % tested, from the day the switchboard is installed and throughout its service life.
- Ensure a lasting investment through easy upgrading of the installation in compliance with the standard.
- Guarantee that the switchboard complies with the technical specifications.

PrismaSeT tested switchboards

The conformity of the switchboard has been tested and proven.

A PrismaSeT switchboard is:

- made up of Schneider Electric low-voltage devices and components that all comply with the applicable standards;
- based on configurations in our catalog;
- made up of PrismaSeT and Linergy mechanical and electrical components that have been subjected to the verification of original equipment manufacturer;
- mounted and wired by a panelbuilder in compliance with professional standards;
- subjected to the individual verification.

Schneider Electric makes available to the panelbuilder everything required to create tested PrismaSeT switchboards, including the basic configurations in the low voltage distribution catalog, all the documentation for switchboard design and mounting, calculation and design software, etc.

Panelbuilders can demonstrate conformity with standard IEC 61439-1 and 2 by presenting the declarations or certificates of conformity for type tests carried out by independent laboratories (ASEFA, ASTA, KEMA, etc.) and supplied by Schneider Electric. The panelbuilder is responsible for the individual routine verification and delivers the corresponding declarations of conformity.



Minimum Distance Around the Switchboard

Top View

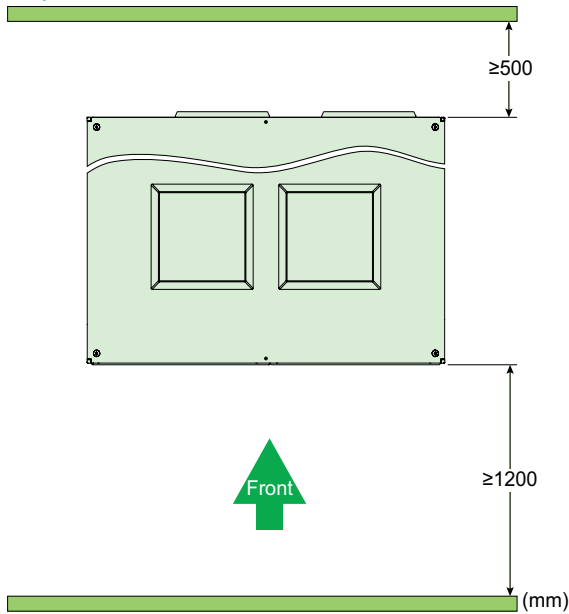

B

Side View

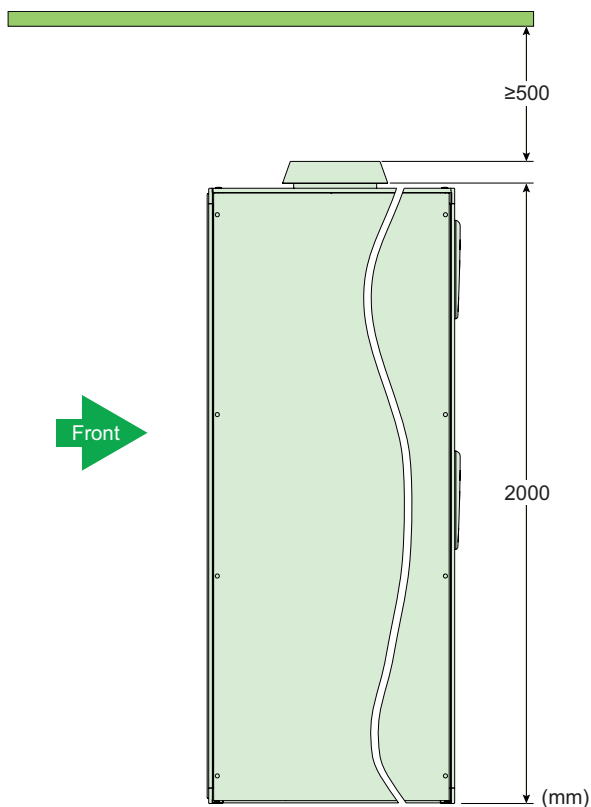

Standards and Certifications

Standards and tested switchboards	C-2
Regional standardization systems	C-2
Standards types	C-3



Standards

Regional standardization systems



Standards and tested switchboards

IEC international standards

IEC member countries

Argentina	Luxemburg
Australia	Malaysia
Austria	Mexico
Belarus	Netherlands
Belgium	New Zealand
Brazil	Norway
Bulgaria	Pakistan
Canada	Poland
China	Portugal
Croatia	Rumania
Czech Rep.	Russia
Denmark	Singapore
Egypt	Slovakia
Finland	Slovenia
France	South Africa
Germany	Spain
Greece	Sweden
Hungary	Switzerland
India	Thailand
Indonesia	Turkey
Iran	Ukraine
Ireland	United Kingdom
Israel	United States
Italy	
Japan	
Korea (Rep. of)	

The IEC (International Electrotechnical Commission) is a worldwide organisation for standardisation comprising all national electrotechnical committees (IEC National Committees).

The object of the IEC is to promote international cooperation on all questions concerning standardisation in the electrical and electronic fields.

To that end, the IEC publishes International Standards.

Their preparation is entrusted to technical committees and any IEC National Committee interested in the subject dealt with may participate in the preparatory work.

Local standards

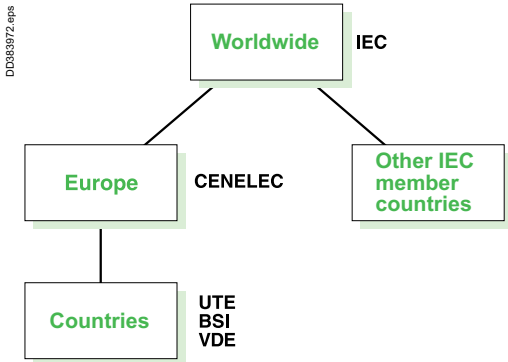

In Europe

The IEC documents are first studied by CENELEC, which establishes:

- either a European standard (EN), often identical to the IEC standard, which then becomes the applicable national standard in all the member countries
- or, in the event of differences, a harmonisation document (HD).

Other IEC member countries

Each country is autonomous and can accept the IEC standard as the national standard, with or without modifications.

Even though they are IEC members, countries such as Japan and the United States continue to develop their own standardisation systems.

Countries without a standardisation system

It is possible to refer to an IEC standard in the framework of a project.

CEI / IEC

Commission Electrotechnique Internationale

CENELEC

Comité Européen de Normalisation ELECTrotechnique

UTE

Union Technique de l'Électricité

VDE

Verband der Elektrotechnik, Elektronik und Informationstechnik

e.v. (German electrotechnical, electronics and computer technology standardisation organisation)

BSI

British Standards Institution



Standards

Standards types



Standards and tested switchboards

The different types of standards

There are different types of standards, including:

- management standards
- installation standards
- product standards.

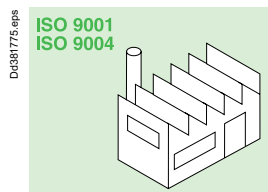

Design and manufacture.

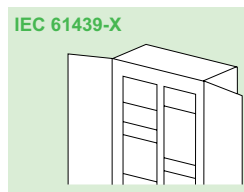

Switchgear and controlgear assemblies.

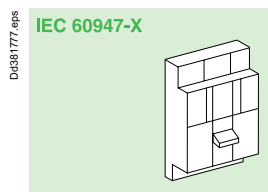

Switchgear and controlgear.

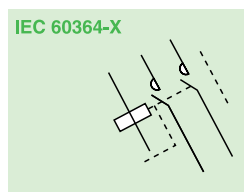

Installation.

Management standards

ISO 9004: Quality-management systems - guidelines for performance improvements. Used in setting up a quality-management system.

ISO 9001: Quality management systems - requirements. Used for certification audits.

ISO 14004: Environmental-management systems. General guidelines on the principles, systems and supporting techniques.

ISO 14001: Environmental-management systems.

Specification with guidance for use

- The majority of Schneider Electric development centres and factories are certified ISO 9001 and ISO 14001.

Installation standards

The set of IEC 60364-X standards defines the main principles and rules on:

- determining general characteristics of installations
- protection
- selection and installation of equipment
- verification and maintenance of installations.

Product standards

They apply to devices or assemblies and are aimed at ensuring correct operation and safety of the concerned products.

- standards on low-voltage switchgear and controlgear:

- IEC 60947-1: general rules
- IEC 60947-2: circuit breakers
- IEC 60947-3: switches and disconnectors
- IEC 60947-4: contactors
- IEC 62208: empty enclosures.

- standards on low-voltage switchgear and controlgear assemblies:

- IEC 61439-1: general rules
- IEC 61439-2: power switchgear and controlgear assemblies
- IEC 61439-3: distribution boards
- IEC 61439-4: assemblies for construction sites
- IEC 61439-5: assemblies for power distribution
- IEC 61439-6: busbar trunking systems.

Regulations in a given country may make certain standards legally binding and may also create additional safety requirements.

In addition to providing proof of the conformity of its quality-management system, a product manufacturer can demonstrate the quality of products by providing proof that the design and manufacture comply with the requirements in the applicable standard.

Proof of conformity may be a declaration by the manufacturer or a certificate supplied by an independent organisation.

Selection Guide

Selection guide

D-2

Select a cubicle configuration

D-2

D

Starting with the electrical diagram:
 IP54 switchboard

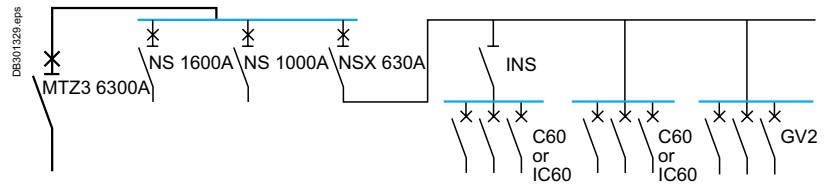

Install the incomer

PrismaSeT 6300 Functional Units

- 1 Define incoming cables connection
- 2 Mount incomer device
- 3 Linergy LGYE 6300 connection

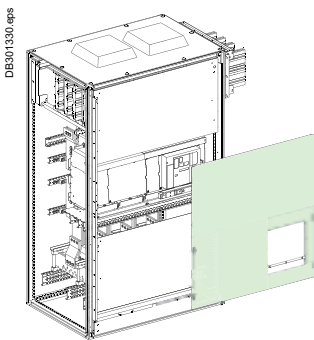

Incoming Cables Connection

Devices	Withdrawable device	
	MTZ3 6300 4P	
Mounting	Front connection with cables	Front connection with Canalis Interface
Number of devices per row	1	1
No. of vertical modules	38	38
Mounting Plate	LVS03509	LVS03509
Front Plates upstream	LVS03708 [13]	LVS03708 [13]
[No. of vertical modules] with cut-out	LVS03707 [12]	LVS03707 [12]
downstream	LVS03708 [13]	LVS03708 [13]
Cross rails required to support mounting plate and must be made connections	2 x set of NSYSUCR90120 2 x set of NSYSUCR9080 2 x set of NSYSUCR40120 1 x set of NSYSUCR65120 1 x set of NSYSUCR6580 LVS04631	2 x set of NSYSUCR9080 2 x set of NSYSUCR40120 1 x set of NSYSUCR65120 1 x set of NSYSUCR6580
Support for cross rails and bars	3 x LVS04678	3 x LVS04678
Interface	-	3P LVMZ1207 4P LVMZ1208
Links on horizontal busbars Linergy LGYE 6300A	Must be made	Must be made

Install functional units up to 3200 A

PrismaSeT P Functional Units

- 1 Installation

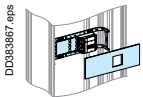

- 2 Lynergy LGY BB conn.

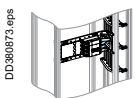

- 3 Connection with vertical BB must be made

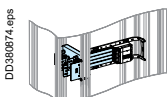

See **PrismaSeT P** catalog (DESW024EN) to design the functional units up to 4000 A



Determine the size of the switchboard:

- Count the number of modules occupied
- Determine the number of cubicles
- Order the additional plain front plates



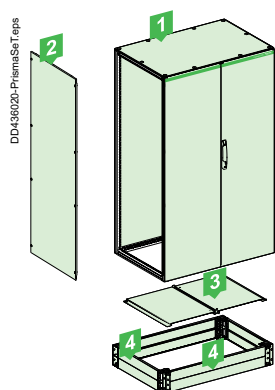

Select the enclosures

PrismaSeT 6300 cubicles

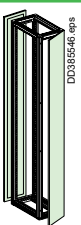

Switchboard 1 - Enclosure for the MTZ3 installation, W = 1200, D = 800

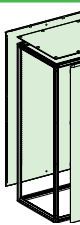
Mounting	Enclosures for front connection			
	300	500	700	1200
 Width (mm) 300 Depth 800 mm	 Width (mm) 500 Depth 800 mm	 Width (mm) 700 Depth 800 mm	 Width (mm) 1200 Depth 800 mm	
Assembled enclosure plain door	NSYSFN20380ED	NSYSFN20580ED	NSYSFPN20780ED	NSYSFN201280DED
Assembled enclosure glazed door	-	-	NSYSFPN20780TED	-
Uprights for Linergy LGY mounting	NSYSFPAED + NSYSUCR40200	-	-	-
Additional flanges for 5000 to 6300 A	-	LVS03598 (2 flanges are included)	LVS06569 (1 flange is included)	LVS03599 (2 flanges are included)
Additional intermediary uprights for Linergy 6300A	-	LVS03589 (2 uprights are included)	LVS03589 (2 uprights are included)	NSYVR18 (2 uprights are included)



Plan the distribution system

Linergy distribution systems

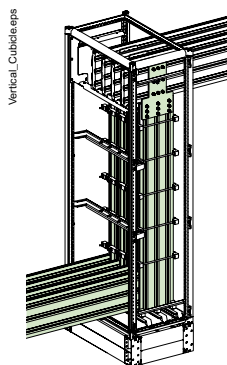

Permissible current and selection of Linergy LGYE busbars
Up to 6300 A
Linergy LGYE section

Type of bars	Permissible current (A)											
	Ambient temperature around the switchboard											
	25 °C		30 °C		35 °C		40 °C		50 °C			
Size per phase	IP ≤ 31	IP > 31	IP ≤ 31	IP > 31	IP ≤ 31	IP > 31	IP ≤ 31	IP > 31	IP ≤ 31	IP > 31		
Linergy LGYE 630	680	580	650	550	630	530	590	500	550	470	520	•
Linergy LGYE 800	860	740	830	710	800	680	750	630	700	600	660	•
Linergy LGYE 1000	1080	920	1040	884	1000	850	940	790	880	750	830	•
Linergy LGYE 1250	1350	1150	1300	1100	1250	1050	1170	1000	1100	930	1020	•
Linergy LGYE 1600	1730	1580	1690	1530	1650	1480	1550	1380	1450	1300	1350	•
Linergy LGYE 2000	2200	1810	2100	1730	2000	1650	1900	1560	1810	1480	1720	•
Linergy LGYE 2500	2640	2230	2540	2160	2440	2100	2310	2000	2240	1930	2120	•
Linergy LGYE 3200	3400	3020	3300	2900	3200	2800	3040	2660	2890	2520	2750	•
Linergy LGYE 4000	3800	3510	3710	3430	3620	3350	3450	3180	3280	3020	3120	•
Linergy LGYE 6300 *	5800	5490	5680	5370	5550	5250	5410	5120	5270	4990	5130	4860
Linergy LGYE 6300 (Forced Ventilation)	•	6300	•	6300	•	6300	•	6300	•	6300	•	6300



Functional Units

Circuit breakers	E-3
Dedicated cubicle - W=1200 Cables connection	E-3
Dedicated cubicle - W=1200 Canalis connection	E-4
Dedicated cubicle - W=1200+500 or 500+1200 Coupling	E-5

Switchgears



Upgradeable functional units

Functional units include switchgear mounting plates, front plates, connection supports, barriers...

- MasterPacT MTZ3
From 4000 to 6300 A



- MasterPacT MTZ2
From 800 to 4000 A



- MasterPacT MTZ1
From 600 to 1600 A



- ComPacT NSX up to 630 A



- ComPacT NS from 630b to 1600 A



- ComPacT NS up to 3200 A



- EasyPact from 100 to 630 A



- ComPacT INS-INV250-630 A



- ComPacT INS-INV630-2500 A



- Source changeover systems ComPacT/MasterPacT



- Source changeover systems ComPacT INS



- FuPacT from 32 to 1250 A



- Acti9

Accessories

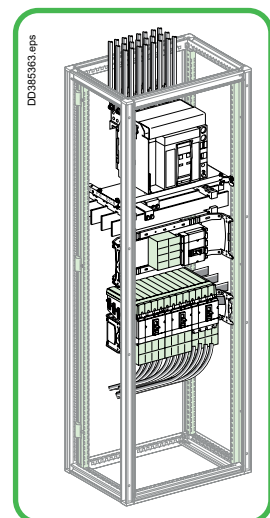

For more informations, see the catalog Prisma**SeT** P - DESW024EN.



MasterPacT MTZ3 40b to 63

Dedicated cubicle - W=1200 Cables connection

Withdrawable

Circuit breakers

Mounting Front connection

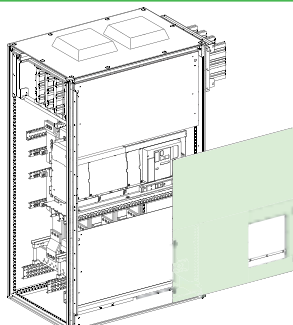
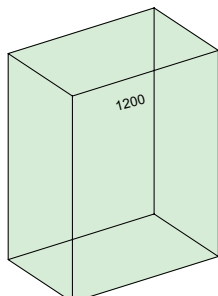

Devices		Withdrawable device
		MTZ3 40-63
Number of devices per row		1
Number of vertical modules		38
Mounting plate		LVS03509
Front plates [No. of vertical modules]	Upstream	LVS03708 [13]
	with cut-out	LVS03707 [12]
	downstream	LVS03708 [13]
Cross rails required for mounting plate support		1 x set of NSYSUCR9080 (2 pieces)

Connection Upstream on incomer

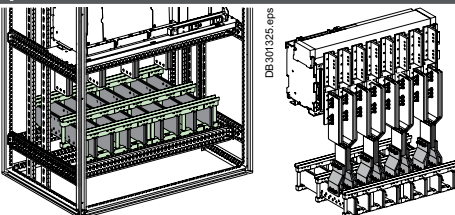

Devices		Withdrawable device
		MTZ3 40-63
Type of terminals		Top & bottom rear vertical connections supplied with the device, needs to be replaced by 3 x set of 87233 for 3P device (12 pieces) or 4 x set of 87233 for 4P device (16 pieces) (1) (2)
Connection		must be made (3)
Connections cross bar support		LVS04631
Cross rails required to support the connections to be made		2 x set of NSYSUCR90120 (4 pieces) 1 x set of NSYSUCR9080 (2 pieces) 2 x set of NSYSUCR40120 (4 pieces)

Distribution Links on horizontal busbars Linergy LGYE 6300 A

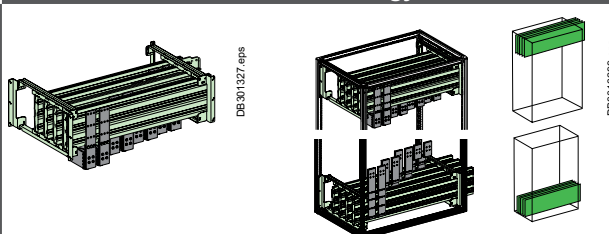

Devices		Withdrawable device
		MTZ3 40-63
Type of device terminal pad		3 x set of 87233 for 3P device (12 pieces) (1) (2) 4 x set of 87233 for 4P device (16 pieces) (1) (2)
Connection		must be made (3)
Cross rails required to support the connections to be made		1x set of NSYSUCR65120 1x set of NSYSUCR6580
Support for cross rails		3x LVS04678

(1) This represents the total required quantity for the replacement of existing pad on the device for both top and bottom device connection.
 (2) Do not throw away top & bottom connections supplied with the device. They will need to be used as connection links to the must be made connections.
 (3) Connection to be made according to the busbar drawings supplied by Schneider Electric.

MasterPacT MTZ3 40b to 63

Dedicated cubicle - W=1200 Canalis connection

Withdrawable

Circuit breakers

Mounting Front connection

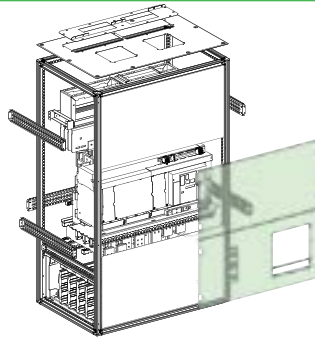
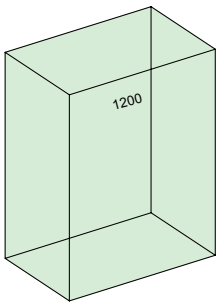

Devices	Withdrawable device
	MTZ3 40-63
Number of devices per row	1
Number of vertical modules	38
Mounting plate	LVS03509
Front plates [No. of vertical modules]	Upstream LVS03708 [13]
	with cut-out LVS03707 [12]
	downstream LVS03708 [13]
Cross rails required for mounting plate support	2 x NSYSUCR9080

Connection Upstream on incomer

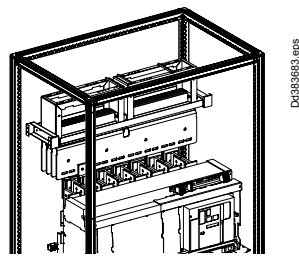

Devices	Withdrawable device
	MTZ3 63
Type of terminals	Top & bottom rear vertical connections supplied with the device, needs to be replaced by 3 x set of 87233 for 3P device (12 pieces) or 4 x set of 87233 for 4P device (16 pieces) (1) (2)
Canalis support	1x set of NSYSUCR6580
Canalis interface bracket	LVS04739
Canalis interface (4)	3P 4P
	LVMZ1207 LVMZ1208
Front connection Extension bars	must be made (3)

Distribution Links on horizontal busbars Linergy LGYE 6300 A

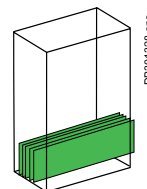
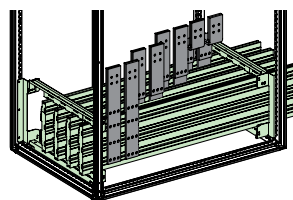

Devices	Withdrawable device
	MTZ3 40-63
Type of device terminal pad	3 x set of 87233 for 3P device (12 pieces) (1) (2) 4 x set of 87233 for 4P device (16 pieces) (1) (2)
Connection	must be made (3)
Cross rails required to support the connections to be made	1x set of NSYSUCR65120
	1x set of NSYSUCR6580
Support for cross rails	3x LVS04678

(1) This represents the total required quantity for the replacement of existing pad on the device for both top and bottom device connection.
 (2) Do not throw away top & bottom connections supplied with the device. They will need to be used as connection links to the must be made connections.
 (3) Connection to be made according to the busbar drawings supplied by Schneider Electric.
 (4) To tight the screws of the Canalis interface use the special tool 87808.



MasterPacT MTZ3 40b to 63

Dedicated cubicle - W=1200+500 or 500+1200 Coupling

Withdrawable

Circuit breakers

Mounting | **Front connection**

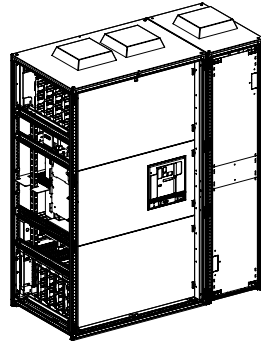
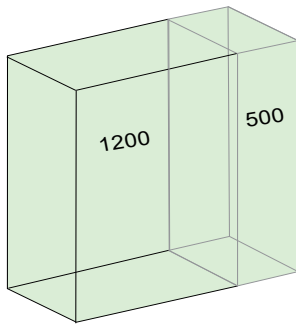

Devices		Withdrawable device
		MTZ3 40-63
Number of devices per row		1
Number of vertical modules		38
Mounting plate		LVS03509
Front plates [No. of vertical modules]	Upstream	LVS03708 [13]
	with cut-out	LVS03707 [12]
	downstream	LVS03708 [13]
Cross rails required for mounting plate support		1 x set of NSYSUCR9080 (2 pieces)

Distribution | **Links on horizontal busbars Linergy LGYE 6300 A**

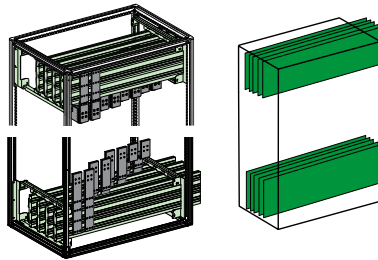

Devices		Withdrawable device
		MTZ3 40-63
Type of device terminal pad		3 x set of 87233 for 3P device (12 pieces) (1) (2) 4 x set of 87233 for 4P device (16 pieces) (1) (2)
Connection		must be made (3)
Cross rails required to support the connections to be made		2 x set of NSYSUCR65120 2 x set of NSYSUCR6580
Support for cross rails		6 x LVS04678

- (1) This represents the total required quantity for the replacement of existing pad on the device for both top and bottom device connection.
- (2) Do not throw away top & bottom connections supplied with the device. They will need to be used as connection links to the must be made connections.
- (3) Connection to be made according to the busbar drawings supplied by Schneider Electric.



Enclosures

Enclosures		F-2
	PrismaSeT 6300 - Enclosures RAL 9003	F-2
	PrismaSeT 6300 - Frameworks	F-4
	PrismaSeT 6300 - IP55 side panels	F-5
	PrismaSeT 6300- Enclosures RAL 7035	F-6
	PrismaSeT 6300- Frameworks	F-8
	PrismaSeT 6300- IP55 side panels	F-9
	Dimensions	F-10
Accessories		F-12
	Coupling kit	F-12
	Plinth	F-13
	Vertical column support	F-14
	Installation accessories	F-15
	Ventilation accessories	F-16
	Roof installation	F-17
	Door handles and locks	F-18

Enclosures

1200 mm width switchboard

For incomer switchboard with front connections.

- assembled Enclosure
- side panels = set of two panels
- gland plates (plain)
- plinth

Parts list for switchboard 1 (depth 800)

- | | | |
|----------|------------------------|--|
| 1 | NSYSFN201280DED | PrismaSeT 6300 - Enclosure for MTZ3 - double door - 2000x1200x800 mm - RAL9003 |
| 2 | NSY2SPN208ED | PrismaSeT 6300 - 2 side panels - 2000x800mm - RAL9003 |
| 3 | NSYEC128 | PanelSeT SFN plain cable gland plate - fixed by clips - 1200x800 mm |
| 4 | NSYSPF12200 | PanelSeT SFN/SM front plinth - 200x1200 mm |
| 4 | NSYSPS8200 | PanelSeT SFN/SM side panel plinth - 200x800 mm |

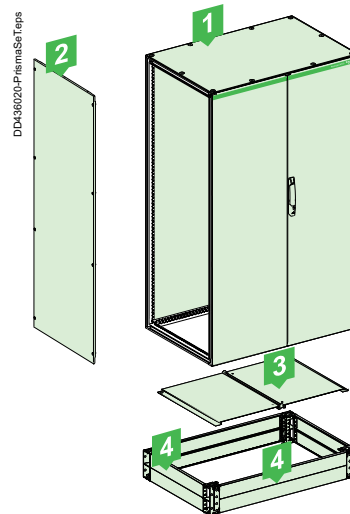

Switchboard 1 - Enclosure for the MTZ3 installation, W = 1200, D = 800

700 mm width switchboard

For switchboard with front connections.

- assembled enclosure
- transparent door or plain door
- gland plates (1 entry).

Parts list for switchboard 2 (depth 800)

- | | | |
|----------|-----------------------|--|
| 1 | NSYSFPN20780ED | PrismaSeT 6300 - Enclosure PrismaSeT FU - plain door - 2000x700x800 mm - RAL9003 |
| 2 | NSYEC781 | PanelSeT SFN 1 entry cable gland plate - fixed by clips - 700x800 mm |
| 3 | NSYSPF7200 | PanelSeT SFN/SM front plinth - 200x700 mm |
| 3 | NSYSPS8200 | PanelSeT SFN/SM side panel plinth - 200x800 mm |

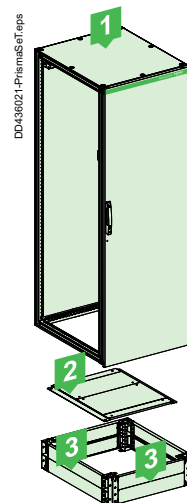

Switchboard 2 - Enclosure for the functional units, W = 700

500 mm width switchboard

Made up of single cubicle used for vertical busbars (above 4000 A) or cable chamber.

Front connections are possible

- assembled enclosure
- gland plates (1 entry)
- plinth

Parts list for switchboard 3 (depth 800)

- | | | |
|----------|----------------------|---|
| 1 | NSYSFN20580ED | PrismaSeT 6300 - Enclosure LGYE6300 busbar - plain door - 2000x500x800 mm - RAL9003 |
| 2 | NSYEC581 | PanelSeT SFN 1 entry cable gland plate - fixed by clips - 500x800 mm |
| 3 | NSYSPF5200 | PanelSeT SFN/SM front plinth - 200x500 mm |
| 3 | NSYSPS8200 | PanelSeT SFN/SM side panel plinth - 200x800 mm |

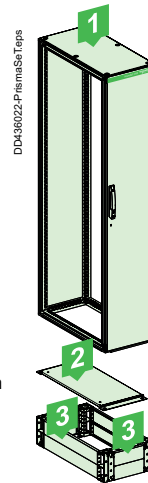

Switchboard 3 - Enclosure for vertical LGYE 6300 installation, W = 500, D = 800

300 mm width switchboard

Made up of single cubicle used for vertical busbars (up to 4000 A) or cable chamber.

Front connections are possible.

- assembled Enclosure
- gland plates (1 entry).

Parts list for switchboard 4 (depth 800)

- | | | |
|----------|----------------------|---|
| 1 | NSYSFN20380ED | PrismaSeT 6300 - Enclosure busbar/cables - plain door - 2000x300x800 mm - RAL9003 |
| 2 | NSYEC381 | PanelSeT SFN 1 entry cable gland plate - fixed by clips - 300x800 mm |
| 3 | NSYSPF3200 | PanelSeT SFN/SM front plinth - 200x300 mm |
| 3 | NSYSPS8200 | PanelSeT SFN/SM side panel plinth - 200x800 mm |

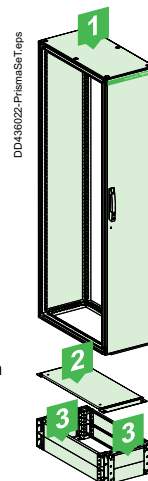

Switchboard 4 - Enclosure for vertical busbar installation or cable management, W = 300



Enclosures

Frameworks

Enclosures

Mounting	Enclosures for front connection			
Width (mm)	300	500	700	1200
	Depth 800 mm			
Assembled enclosure plain door	NSYSFN20380ED	NSYSFN20580ED	NSYSFPN20780ED	NSYSFN201280DED
Assembled enclosure transparent door	-	-	NSYSFPN20780TED	-
Uprights for Linergy LGY mounting	NSYSFPAED + NSYSUCR40200	-	-	-
Additional flanges for 5000 to 6300 A	-	LVS03598 (2 flanges are included)	LVS06569 (1 flange is included)	LVS03599 (2 flanges are included)
Additional intermediary uprights for Linergy 6300A	-	LVS03589 (2 uprights are included)	LVS03589 (2 uprights are included)	LVS06500 + NSYVR18 (2 uprights are included)

Mounting	Fixed front plate support uprights for W1200	Hinged front plate frame support W700
Width (mm)	1200	700
Cat. no.	LVS03591	LVS08566
Characteristics	-	<ul style="list-style-type: none"> Reversible for left or right-hand opening. Secured at two points.



Enclosures

IP55 side panels

Enclosures

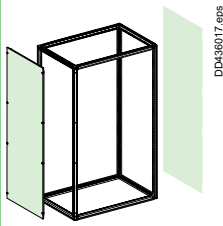
Mounting	Side panels			
				
Dimensions (mm)	W = 300	W = 500	W = 700	W = 1200
Dimensions (mm)	D = 800			
Side panels	NSY2SPN208ED			
Characteristics	Supplied with quarter-turn fasteners.			

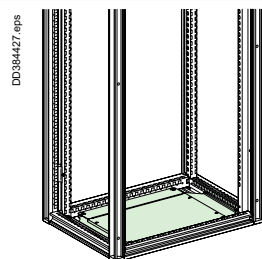
Mounting	Gland plates			
				
Dimensions (mm)	W = 300 mm	W = 500 mm	W = 700 mm	W = 1200 mm
D800	NSYEC381	NSYEC581	NSYEC781	NSYEC128

Note: Gland plates with 1 cable entry for W300/500/700 mm. No cable entry for W1200 mm.



Enclosures

1200 mm width switchboard

For incomer switchboard with front connections.

- assembled Enclosure
- side panels = set of two panels
- gland plates (plain)
- plinth

Parts list for switchboard 1 (depth 800)

- | | | |
|----------|-----------------------|--|
| 1 | NSYSFN2012802D | PanelSeT SFN enclosure without mounting plate - assembled - 2000x1200x800 mm |
| 2 | NSY2SPN208 | PanelSeT SFN external fixing side panels - 2000x800 mm |
| 3 | NSYEC128 | PanelSeT SFN plain cable gland plate - fixed by clips - 1200x800 mm |
| 4 | NSYSPF12200 | PanelSeT SFN/SM front plinth - 200x1200 mm |
| 4 | NSYSPS8200 | PanelSeT SFN/SM side panel plinth - 200x800 mm |

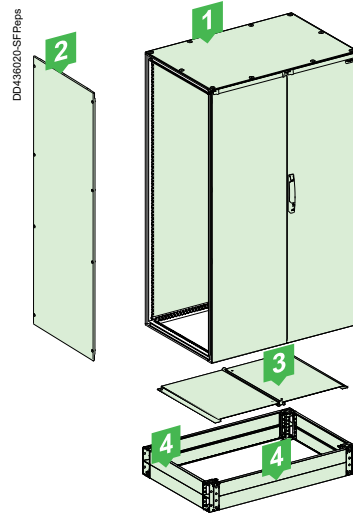

Switchboard 1 - Enclosure for the MTZ3 installation, W = 1200, D = 800

700 mm width switchboard

For switchboard with front connections.

- assembled enclosure
- transparent door or plain door
- gland plates (1 entry)
- plinth

Parts list for switchboard 2 (depth 800)

- | | | |
|----------|----------------------|---|
| 1 | NSYSFPN20780G | PrismaSeT 6300 - Enclosure PrismaSeT FU - plain door - 2000x700x800mm - RAL7035 |
| 2 | NSYEC781 | PanelSeT SFN 1 entry cable gland plate - fixed by clips - 700x800 mm |
| 3 | NSYSPF7200 | PanelSeT SFN/SM front plinth - 200x700 mm |
| 3 | NSYSPS8200 | PanelSeT SFN/SM side panel plinth - 200x800 mm |

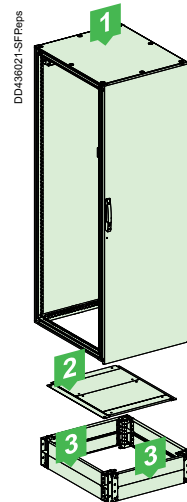

Switchboard 2 - Enclosure for the functional units, W = 700

500 mm width switchboard

Made up of single cubicle used for vertical busbars (above 4000 A) or cable chamber.

Front connections are possible

- assembled enclosure
- gland plates (1 entry)
- plinth

Parts list for switchboard 3 (depth 800)

- | | | |
|----------|--------------------|---|
| 1 | NSYSFN20580 | PanelSeT SFN enclosure without mounting plate - assembled - 2000x500x800 mm |
| 2 | NSYEC581 | PanelSeT SFN 1 entry cable gland plate - fixed by clips - 500x800 mm |
| 3 | NSYS PF5200 | PanelSeT SFN/SM front plinth - 200x500 mm |
| 3 | NSYS PS8200 | PanelSeT SFN/SM side panel plinth - 200x800 mm |

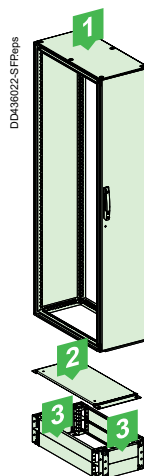

Switchboard 3 - Enclosure for vertical LGYE 6300 installation, W = 500, D = 800

300 mm width switchboard

Made up of single cubicle used for vertical busbars (up to 4000 A) or cable chamber.

Front connections are possible.

- assembled Enclosure
- gland plates (1 entry)
- plinth

Parts list for switchboard 4 (depth 800)

- | | | |
|----------|--------------------|---|
| 1 | NSYSFN20380 | PanelSeT SFN enclosure without mounting plate - assembled - 2000x300x800 mm |
| 2 | NSYEC381 | PanelSeT SFN 1 entry cable gland plate - fixed by clips - 300x800 mm |
| 3 | NSYS PF3200 | PanelSeT SFN/SM front plinth - 200x300 mm |
| 3 | NSYS PS8200 | PanelSeT SFN/SM side panel plinth - 200x800 mm |

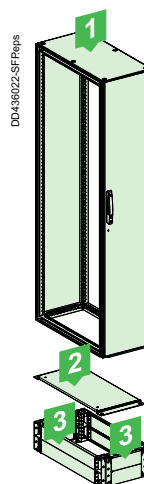

Switchboard 4 - Enclosure for vertical busbar installation or cable management, W = 300



Enclosures
Frameworks

Enclosures

Mounting	Enclosures for front connection			
Width (mm)	300	500	700	1200
	Depth 800 mm			
Assembled enclosure plain door	NSYSFN20380	NSYSFN20580	NSYSFPN20780G	NSYSFN2012802D
Assembled enclosure transparent door	-	-	NSYSFPN20780TG	-
Uprights for Linergy LGY mounting	NSYSFPAED + NSYSUCR40200	-	-	-
Additional flanges for 5000 to 6300 A	-	LVS03598 (2 flanges are included)	LVS06569 (1 flange is included)	LVS03599 (2 flanges are included)
Additional intermediary uprights for Linergy 6300A	-	LVS03589 (2 uprights are included)	LVS03589 (2 uprights are included)	LVS06500 + NSYVR18 (2 uprights are included)
Mounting	Fixed front plate support uprights for W1200	Hinged front plate frame support W700		
Width (mm)	1200	700		
Cat. no.	LVS03591	LVS08566		
Characteristics	-	<ul style="list-style-type: none"> Reversible for left or right-hand opening. Secured at two points. 		



Enclosures
IP55 side panels

Enclosures

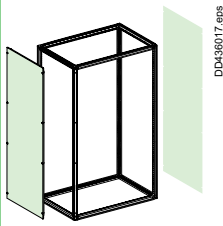
Mounting		Side Panels			
					
Dimensions (mm)	W = 300	W = 500	W = 700	W = 1200	
Dimensions (mm)	D = 800				
Side panels	NSY2SPN208				
Characteristics	Supplied with quarter-turn fasteners.				

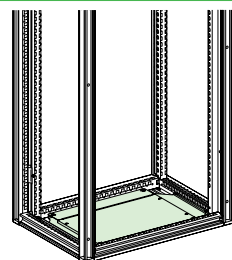
Mounting		Gland plates			
					
Dimensions (mm)	W = 300 mm	W = 500 mm	W = 700 mm	W = 1200 mm	
D800	NSYEC381	NSYEC581	NSYEC781	NSYEC128	

Note: Gland plates with 1 cable entry for W300/500/700 mm. No cable entry for W1200 mm.

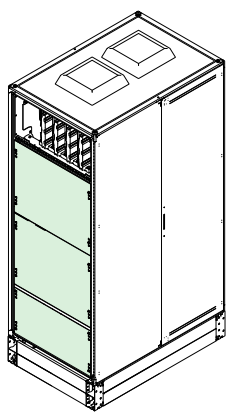
Description		Catalog Number
	Inter-column partition	LVS04979
	<ul style="list-style-type: none"> ■ Systematically install partitions at each end of the switchboard. ■ A column added to an existing switchboard must receive an inter-column partition at its left. ■ It gives way to the horizontal busbar. ■ It can be installed between any compartment or cubicle in order to partition specific areas in the switchboard. 	

Enclosures

Dimensions

Dimensions

Frameworks

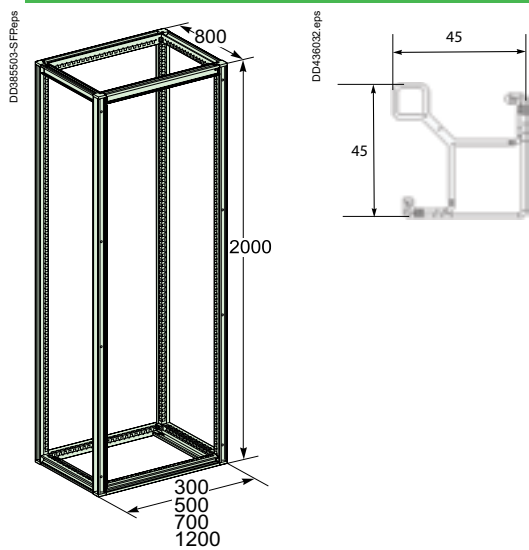

Fixing to floor

Without plinth

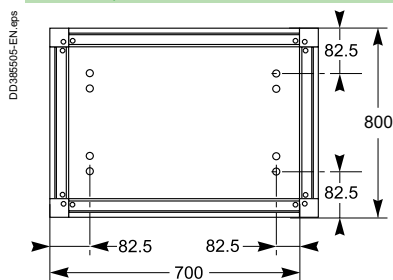

Cubicle with cover panels

Height

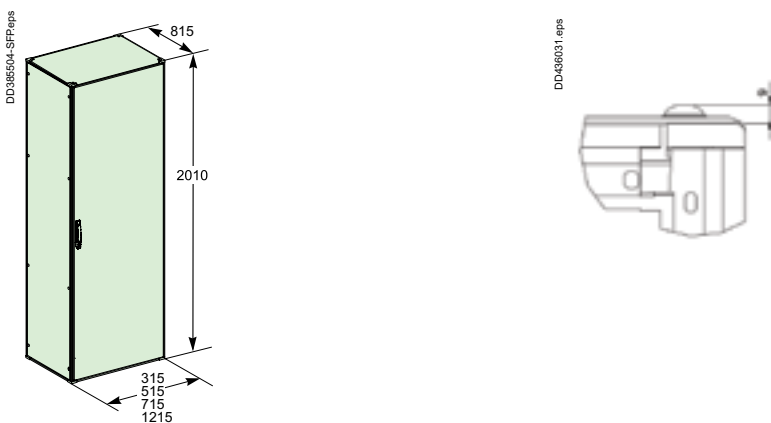

Enclosures

Dimensions

Dimensions

Gland plates

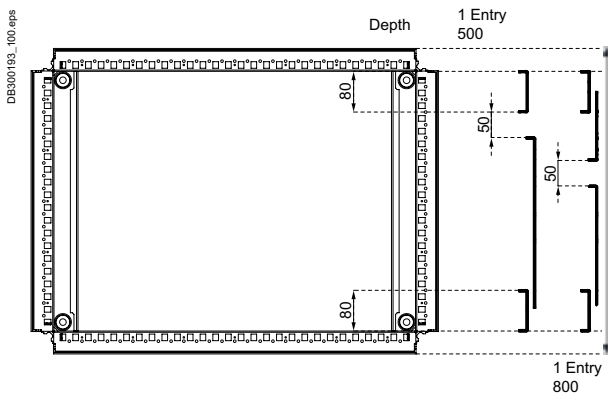

Busbars mounting, lateral vertical busbars

2500 A to 6300 A

>4000 A - up to 6300 A

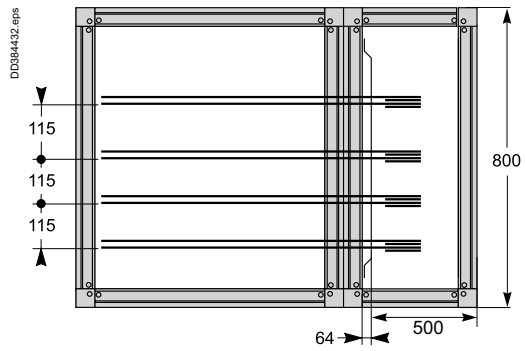
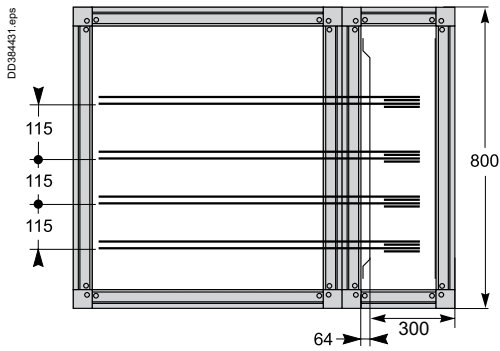

Accessories

Coupling kit

Enclosures

Coupling kit	
Type	Side-by-side
Cat. no.	NSYSFBK19

Accessories	
Type	Commodities
	Fixing screws and nuts
Cat. no.	LVS08921
Characteristics	Set of 20 screws

Accessories

Plinth

Enclosures

Mounting	Plinth H = 100 mm	Plinth H = 200 mm
----------	-------------------	-------------------

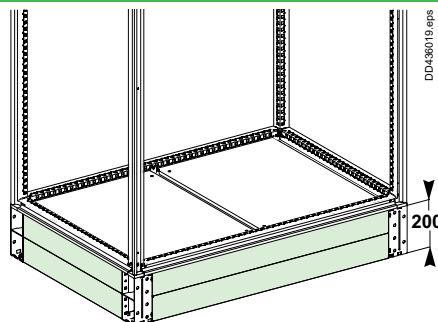
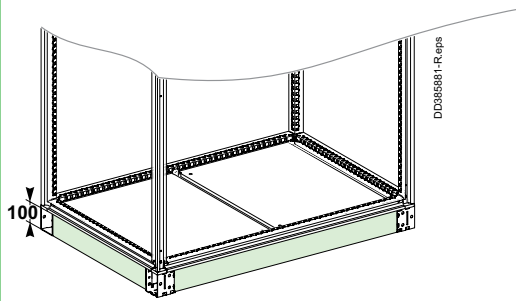

Dimensions (mm)		W = 300	W = 500	W = 700	W = 1200	W = 300	W = 500	W = 700	W = 1200
Front and rear cross-pieces	D=800	NSYSPPF3100	NSYSPPF5100	NSYSPPF7100	NSYSPPF12100	NSYSPPF3200	NSYSPPF5200	NSYSPPF7200	NSYSPPF12200
Lateral cross-pieces	D = 800	NSYSPPS8100	NSYSPPS8100	NSYSPPS8100	NSYSPPS8100	NSYSPPS8200	NSYSPPS8200	NSYSPPS8200	NSYSPPS8200

Characteristics

The plinth is made up of two catalog numbers:

- one catalog number comprising four corner posts + two cross-pieces (front and rear), that can be used in side-by-side combinations or stacked to form a plinth 200 mm high (maximum)
- one catalog number comprising two side plates.

Each catalog number is supplied with the necessary hardware.

Examples

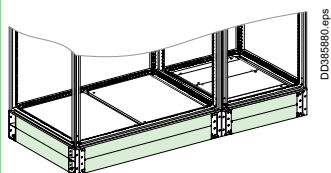

Side-by-side combination of two cubicles with a plinth.

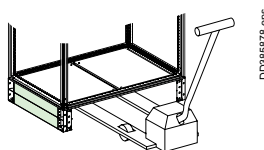

The front and rear cross-pieces can be easily removed for a pallet-mover.

⚠ WARNING



TIP OVER HAZARD

- Read and apply user instructions before work:
 - Secure the product in place.
 - Secure the product if removing the securing bolts or moving the product.
 - Use appropriate lifting equipment.
- Use trained personnel only, who know and understand the user instructions.

Failure to follow these instructions can result in death, serious injury, or product damage.



Accessories

Vertical Column Support

Enclosures

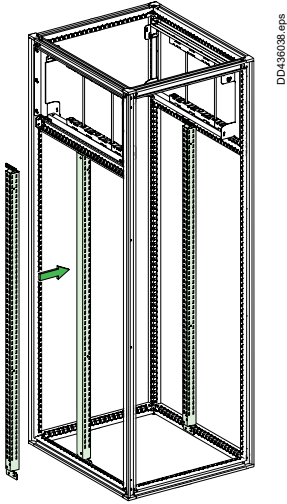
Mounting				
Vertical Column Support				
				
Width (mm)	300	500	700	1200
	Depth 800 mm			
Cat. no.	-	LVS03589	LVS03589	-
Characteristics	<ul style="list-style-type: none"> It is mandatory only when the horizontal LGYE 6300 busbar is inside the column. 			

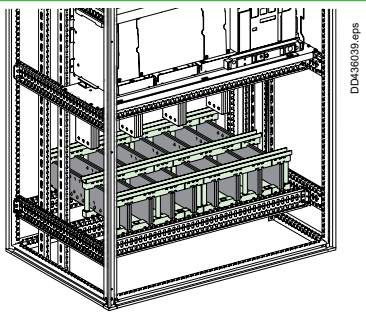
Mounting				
				
Width (mm)	300	500	700	1200
	Depth 800 mm			
Cat. no.	-	-	-	LVS04631

Accessories

Installation accessories

Enclosures

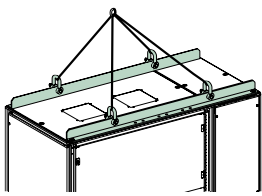

Mounting	Lifting bar
	 <p style="text-align: right; font-size: small;">PD091295.eps</p> <div style="border: 1px solid black; padding: 5px; margin-top: 10px;"> <p style="text-align: center;">⚠ WARNING</p> <p>HAZARD OF DROPPING</p> <ul style="list-style-type: none"> Use strong slings with a valid use-by date when lifting with cranes. Attach the slings to the 4 lifting rings of the lifting bar of the cubicles. Secure the plinth of floor standing enclosure using the fasteners. <p>Failure to follow these instructions can result in death, serious injury, or equipment damage.</p> </div>
Cat. no.	NSYSFTB16
Characteristics	<ul style="list-style-type: none"> Set of bars for lifting and transporting enclosures suites. They are fixed to the structure of the enclosure, in the axis of the uprights. Material: Steel.



Accessories

Ventilation accessories

Others

Forced-air ventilation		560 m ³ /hr	850 m ³ /hr
			
Cat. no.		NSYCVF560M230PF	NSYCVF850M230PF
Unimpeded throughput via filter (m ³ /hr)	50 Hz	562	838
	60 Hz	586	803
Throughput via outlet grill (m ³ /hr)	50 Hz	473	718
	60 Hz	477	568
Power drawn (W) (max. intensity (A))		68/85 (0.52/0.370)	150/195 (0.65/0.85)
Noise level (dB (A))		59/59	76/75
External dimensions (cutting)		336 x 316 x 161 (291 x 291)	336 x 316 x 162 (291 x 291)
Weight (kg)		3.2	4.1
Operating temperature		-15...+60 C	-15...+60 C

Outlet grill		
Cat. no.	NSYCAG291LPF	NSYCAG291LPF

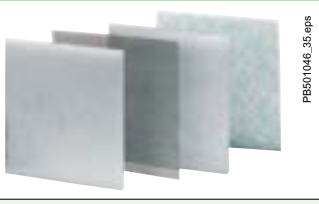
Filters for outlet grill		
		
G2 M1 standard filters	NSYCAF291	NSYCAF291
G3 M1 fine filters	NSYCAF291T	NSYCAF291T
Characteristics	Set of 5 (for replacement) Synthetic filters	

Note: For other usage voltage like 50V or 110V, see Universal Enclosures catalog, cat. no. UEMKCAT001EN and UEMKCAT002EN.

Dimensions

A	B	Cat. no.
225	160.5	NSYCVF560M230PF
280	192	NSYCVF850M230PF

NSYCVF560M230PF - NSYCVF850M230PF

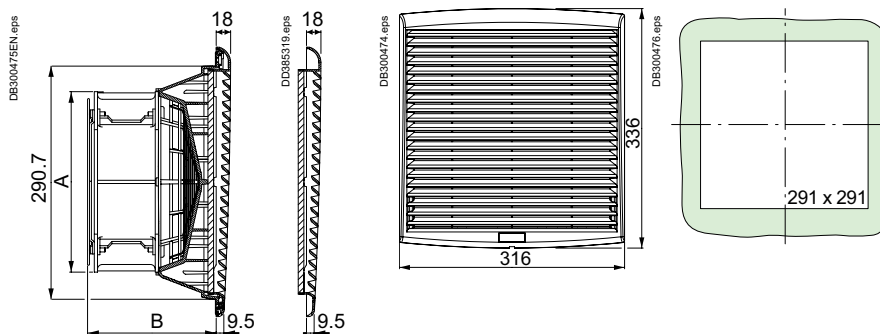

Accessories
Roof installation

Others

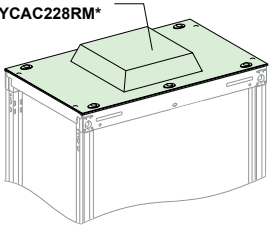
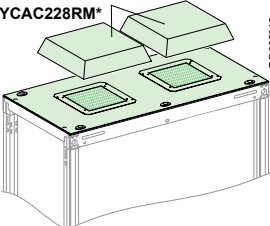
Roof ventilation	Width 500 and 700	Width 1200
	<p>NSYCVF575M230M* or NSYCAC228RM*</p> 	<p>2 x NSYCVF575M230M* or 2 x NSYCAC228RM*</p> 
Forced ventilation top hood with fan		
Catalog numbers	NSYCVF575M230MF (RAL7035 Grey) / NSYCVF575M230MB (RAL9003 White)	
Characteristics	<p>Fan characteristics</p> <ul style="list-style-type: none"> ▪ Power: 575 W ▪ Input voltage: 230 V ▪ Throughput via outlet grill: <ul style="list-style-type: none"> □ with 1 outlet grill: 350 m³/hr □ Free with filter: 575 m³/hr □ Finishing parts: painted with epoxy-polyester resin ▪ Noise level: 64 dB. 	
Natural ventilation top hood without fan		
Catalog numbers	NSYCAC228RMF (RAL7035 Grey) / NSYCAC228RMB (RAL9003 White)	
Characteristics	<ul style="list-style-type: none"> ▪ Material: steel ▪ Finishing parts: painted with epoxy-polyester resin ▪ IP54 ▪ Fixing to the top by means of caged nuts and special screws 	
Air-flow cross section = 304 cm without electrical fan	2 x 304 cm	



Accessories

Door handles and locks

Others

Locking system

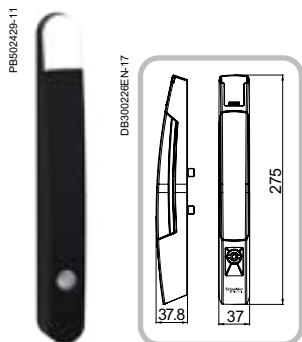

Characteristics	Handle for shape inserts and cylindrical barrels
	Easy to change the opening direction of the door, right/left. Space reserved for enclosure identification, 21 x 27 mm, protected by a label frame.
Material	Handle: polyamide 6 with 30 % fibreglass, RAL 9005 colour
Mechanical protection rating	IK10
Fire resistance	650°C
Supply	Standard handle and fixing elements (insert not included)
References	NSYSFNHS1

Accessories																																									
<p>Shape inserts</p>	<table border="1"> <thead> <tr> <th>Shape inserts</th> <th>References</th> <th>Cylindrical barrels</th> <th>References</th> </tr> </thead> <tbody> <tr> <td>6-mm square insert</td> <td>NSYINS61</td> <td>405E key lock</td> <td>NSYIN405E1</td> </tr> <tr> <td>7-mm square insert</td> <td>NSYINS71</td> <td>421E key lock</td> <td>NSYIN421E1</td> </tr> <tr> <td>8-mm square insert</td> <td>NSYINS81</td> <td>455 key lock</td> <td>NSYIN4551</td> </tr> <tr> <td>6.5-mm triangular insert</td> <td>NSYINT61</td> <td>1242E key lock</td> <td>NSYIN1242E1</td> </tr> <tr> <td>7-mm triangular insert</td> <td>NSYINT71</td> <td>2131A key lock</td> <td>NSYIN2131A1</td> </tr> <tr> <td>8-mm triangular insert</td> <td>NSYINT81</td> <td>2132A key lock</td> <td>NSYIN2132A1</td> </tr> <tr> <td>9-mm triangular insert</td> <td>NSYINT91</td> <td>2433A key lock</td> <td>NSYIN2433A1</td> </tr> <tr> <td>3-mm double-bar insert</td> <td>NSYINDB31</td> <td>3113A key lock</td> <td>NSYIN3113A1</td> </tr> <tr> <td>5-mm double-bar insert</td> <td>NSYINDB51</td> <td>EDF1300 key lock</td> <td>NSYINF1301</td> </tr> </tbody> </table>	Shape inserts	References	Cylindrical barrels	References	6-mm square insert	NSYINS61	405E key lock	NSYIN405E1	7-mm square insert	NSYINS71	421E key lock	NSYIN421E1	8-mm square insert	NSYINS81	455 key lock	NSYIN4551	6.5-mm triangular insert	NSYINT61	1242E key lock	NSYIN1242E1	7-mm triangular insert	NSYINT71	2131A key lock	NSYIN2131A1	8-mm triangular insert	NSYINT81	2132A key lock	NSYIN2132A1	9-mm triangular insert	NSYINT91	2433A key lock	NSYIN2433A1	3-mm double-bar insert	NSYINDB31	3113A key lock	NSYIN3113A1	5-mm double-bar insert	NSYINDB51	EDF1300 key lock	NSYINF1301
	Shape inserts	References	Cylindrical barrels	References																																					
	6-mm square insert	NSYINS61	405E key lock	NSYIN405E1																																					
	7-mm square insert	NSYINS71	421E key lock	NSYIN421E1																																					
	8-mm square insert	NSYINS81	455 key lock	NSYIN4551																																					
	6.5-mm triangular insert	NSYINT61	1242E key lock	NSYIN1242E1																																					
	7-mm triangular insert	NSYINT71	2131A key lock	NSYIN2131A1																																					
	8-mm triangular insert	NSYINT81	2132A key lock	NSYIN2132A1																																					
	9-mm triangular insert	NSYINT91	2433A key lock	NSYIN2433A1																																					
	3-mm double-bar insert	NSYINDB31	3113A key lock	NSYIN3113A1																																					
5-mm double-bar insert	NSYINDB51	EDF1300 key lock	NSYINF1301																																						
<p>Push button</p>	<table border="1"> <thead> <tr> <th>Push button</th> <th>Reference</th> </tr> </thead> <tbody> <tr> <td>Push button</td> <td>NSYINPULS1</td> </tr> </tbody> </table>	Push button	Reference	Push button	NSYINPULS1																																				
	Push button	Reference																																							
Push button	NSYINPULS1																																								
<p>Cylindrical barrels</p>	<table border="1"> <tbody> <tr> <td>Michelin 8133 keyless lock</td> <td>NSYINICHEL8131</td> </tr> <tr> <td>Michelin 8376 keyless lock</td> <td>NSYINICHEL8371</td> </tr> <tr> <td>E1 keyless lock</td> <td>NSYINE11</td> </tr> </tbody> </table>	Michelin 8133 keyless lock	NSYINICHEL8131	Michelin 8376 keyless lock	NSYINICHEL8371	E1 keyless lock	NSYINE11																																		
	Michelin 8133 keyless lock	NSYINICHEL8131																																							
	Michelin 8376 keyless lock	NSYINICHEL8371																																							
E1 keyless lock	NSYINE11																																								

Linergy Distribution Systems

Power busbars	G-2
Horizontal profiles LGYE up to 6300 A	G-2
Lateral profiles LGYE up to 6300 A	G-4
Accessories	G-6

Linergy LGYE

Horizontal profiles up to 6300 A

Power busbars

Linergy LGYE profiles																
Installation		Up to 1600 A					Up to 4000 A				Up to 6300 A					
Linergy profiles																
		630 A	800 A	1000 A	1250 A	1600 A	2000 A	2500 A	3200 A	4000 A	6300 A					
Permissible current for an ambient temperature of 35 °C around the switchboard (1)		IP < 31 630 A	800 A	1000 A	1250 A	1650 A	2000 A	2440 A	3200 A	3620 A	5200 A (2)					
		IP > 31 530 A	680 A	850 A	1050 A	1480 A	1650 A	2100 A	2800 A	3350 A	6300 A (1)					
Number of profiles per phase		1					1				1					
Total number of vertical modules (50 mm)		3					3				4					
		960 mm									LVS04569					
		1160 mm									LVS04580					
		1360 mm									LVS04581					
		1690 mm									LVS04582					
		2000 mm					LVS04560	LVS04561	LVS04562	LVS04563	LVS04564	LVS04565	LVS04566	LVS04567	LVS04568	-

Note: (1) With forced ventilation
 (2) With Natural Ventilation
 (3) Without form 2 partitioning of horizontal busbars

Busbar supports		Up to 6300 A	
	Fixed support		LVS04660
	Free support		LVS04675
	Characteristics	2 fixed supports for 1200 wide frame 2 fixed supports for PrismaSeT 6300 700 wide frame are compulsory. 1 fixed support for 300 wide frame are compulsory. 2 fixed support for 500 wide frame are compulsory. If more supports are needed, add free supports.	
In cubicle: PrismaSeT 6300 W1200 or W700 busbar supports 115mm between centres	Number of supports depending on low (KA rms/1 s)	≤ 15: 2 ≤ 25: 2 ≤ 30: 2 ≤ 40: 2 ≤ 50: 2 ≤ 60: 2 + 1 ≤ 65: 2 + 1 ≤ 75: 2 + 1 ≤ 85: 2 + 1 ≤ 100: 2 + 3	



Linergy LGYE

Horizontal profiles up to 6300 A

Power busbars

Busbar supports

In cubicle: PrismaSet 6300 W500	Number of supports depending on I _{cw} (kA rms/1 s)	≤ 15	-			2*
		≤ 25	-			2*
		≤ 30	-			2*
		≤ 40	-			2*
		≤ 50	-			2*
		≤ 60	-			2*
		≤ 65	-			2*
		≤ 75	-			2*
		≤ 85	-			2*
		≤ 100	-		2 + 1	
Catalog numbers	Fixed support	LVS04664	LVS04664 + LVS04671 (order 1 per support)	LVS04664 + LVS04646 (sold in lots of 12 spacers)	LVS04660 + NSYSUCR6580	
	Free support	LVS04662	LVS04662 + LVS04671 (order 1 per support)	LVS04662 + LVS04646 (sold in lots of 12 spacers)	LVS04675	
In cubicle: PrismaSet 6300 W700	Number of supports depending on I _{cw} (kA rms/1 s)	≤ 15	2			-
		≤ 25	2			-
		≤ 30	2			-
		≤ 40	-	2		-
		≤ 50	-	2		2
		≤ 60	-		2+1	
		≤ 65	-		2+1	
		≤ 75	-		2+1	
		≤ 85	-		2+1	
		≤ 100	-		-	2+2
Catalog numbers	Fixed support	LVS04664	LVS04664 + LVS04671 (order 1 per support)	LVS04664 + LVS04646 (sold in lots of 12 spacers)	LVS04660 + NSYSUCR6580	
	Free support	LVS04662	LVS04662 + LVS04671 (order 1 per support)	LVS04662 + LVS04646 (sold in lots of 12 spacers)	LVS04675	
In cubicle: PrismaSet 6300 W1200	Number of supports depending on I _{cw} (kA rms/1 s)	≤ 15	-			2
		≤ 25	-			2
		≤ 30	-			2
		≤ 40	-			2
		≤ 50	-			2+3
		≤ 60	-			2+3
		≤ 65	-			2+3
		≤ 75	-			2+3
		≤ 85	-			2+3
		≤ 100	-			2+3
Catalog numbers	Fixed support	-	-	-	-	LVS04660 + NSYSUCR6580
	Free support	-	-	-	-	LVS04675

Note: * no free support with vertical busbar cubicle

Joints

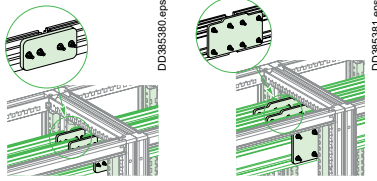
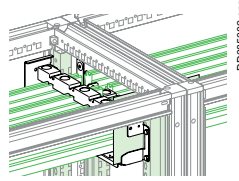
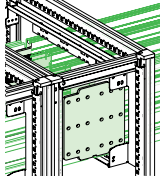
Installation	Up to 1600 A					Up to 4000 A				Up to 6300 A
	630 A	800 A	1000 A	1250 A	1600 A	2000 A	2500 A	3200 A	4000 A	6300 A
Linergy profiles										
Catalog numbers	3 x LVS04620 (3P) 4 x LVS04620 + LVS04624 (4P)					3 x LVS04621 (3P) 4 x LVS04621 + LVS04624 (4P)		3 x LVS04623 (3P) 4 x LVS04623 + LVS04624 (4P)		3 x LVS04625 (3P) 4 x LVS04625 (4P)
Note	Reference LVS04624 is compulsory when installing jointed Linergy LGYE 4P busbars and must be fitted where the frames meet. When installed at the bottom of a cubicle, the busbar must be partitioned.									Busbar should be partitioned properly and linked using LVS04625 with torque (28 Nm). Sold with shrinkable nuts M8 + insert studs



Linergy LGYE

Lateral profiles up to 6300 A

Power busbars

Linergy LGYE profiles		Up to 6300 A			
In PrismaSeT 6300 duct Linergy profile, 2000 mm length for all the ratings except 6300 A: 1625 mm length		W300 			
		630 A	800 A	1000 A	1250 A
Permissible current for an ambient temperature of 35 C around the switchboard	IP 31 IP > 31	530 A 630 A	680 A 800 A	850 A 1000 A	1050 A 1250 A
Length to cut for side mounting		1675 mm			
Number of profiles per phase		1			
Cat. no.		LVS04560	LVS04561	LVS04562	LVS04563
Width of duct		300 mm			

Busbar supports				
		Fixed support for current ratings less than 4000A: LVS04649	Fixed Support for 4000A and above 6300A: LVS04654	Free support up to 4000A: LVS04678
Number depending on lcv (kA rms/1 s)		30 40 50 60 65 75 85 100	3 ⁽²⁾ - - - - - - -	- - - 3 ⁽²⁾ +2 ⁽³⁾ 3 ⁽²⁾ +2 ⁽³⁾ - - -
Cat. no. of supports depending on distance between bars and duct depth	Duct 115 mm = HBB up to 4000 A distance between bars Duct 115 mm = HBB up to 6300 A distance between bars	W300, D800 W500, D800	LVS04649 (fixed) + LVS04678 (free) + LVS04648 (bottom) ⁽¹⁾ LVS04654 (fixed) + LVS04655 (bottom)	

(1) If using a 100 x 10 bars, add a pack of screws ref. LVS04671 for each fixed support and free support, (2) for fixed support, (3) for free support.

Note: * without forced cooling. ** with forced cooling. *** for bottom LGYE HBB connection.

Wedging busbars in position		
Characteristics The bottom support is used to place profiles and ensure they are in the correct position. It is not considered to be a busbar support.		Wedge fitted on bottom support DD385472 eps
Cat. no.	LVS04658 (pack of 12 stops)	

Connections to the Linergy LGYE horizontal busbar		
Characteristics Supplied with mounting hardware. Reference include 1 connection only. Order 1 connection per phase.		2000/2500 A DD385368 eps
Cat. no.	LVS04604 (short connection) LVS04605 (long connection)	



Linergy LGYE

Lateral profiles up to 6300 A

Power busbars

1600 A	2000 A	2500 A	3200 A	4000 A	6300 A
1480 A	1650 A	2100 A	2800 A	3620	5200*
1650 A	2000 A	2440 A	3200 A	3350	6300**
			1625 mm		1690 mm

LVS04564	LVS04565	LVS04566	LVS04509	LVS04510	LVS04582
					500 mm

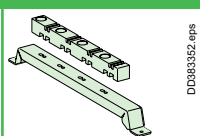

Bottom Support for current ratings less then 4000A: NSYAS500 | Bottom Support for 4000A and above 6300A: LVS04655



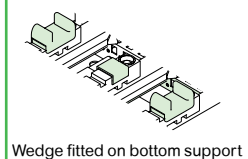
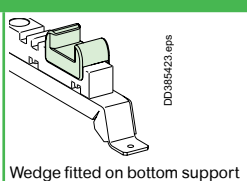

					2 ⁽²⁾ +2 ⁽³⁾
	3 ⁽²⁾				2 ⁽²⁾ +2 ⁽³⁾
	3 ⁽²⁾				2 ⁽²⁾ +2 ⁽³⁾
			3 ⁽²⁾		2 ⁽²⁾ +2 ⁽³⁾
3 ⁽²⁾ +2 ⁽³⁾					2 ⁽²⁾ +2 ⁽³⁾
3 ⁽²⁾ +4 ⁽³⁾			3 ⁽²⁾ +2 ⁽³⁾		2 ⁽²⁾ +2 ⁽³⁾
3 ⁽²⁾ +4 ⁽³⁾					2 ⁽²⁾ +3 ⁽³⁾
		3 ⁽²⁾ +6 ⁽³⁾			2 ⁽²⁾ +3 ⁽³⁾



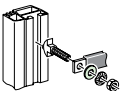

LVS04659 (pack of 12 replacement stops) | **LVS04655 (Included with busbar support kit)**

2000/2500 A	3200/4000 A	6300 A

3*LVS04639 (3P) 4*LVS04639 (4P)	3*LVS04622 (3P) 4*LVS04622 (4P)	3*LVS04627 (3P) 4*LVS04627 (4P)
------------------------------------	------------------------------------	------------------------------------

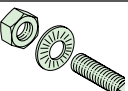
Accessories										
										
Cat. no.	LVS04766	LVS04767	LVS04772	LVS04773	LVS04774	LVS04775	LVS04794	LVS01130	LVS04768	LVS04769
Characteristics	L 25 mm	L 39 mm	20 mm ext. Ø	24 mm ext. Ø	28 mm ext. Ø	20 mm ext. Ø		2 studs	2 studs	3 studs
	Set of 20: 20 bolts + 20 nuts + 20 contact washers, class 8.8. The screws slide into the profile and are then locked in the desired position.		M8 set of 20			M8 sold in lots of 20 for connection of ≤ 25 mm ² lugs to Linergy	12 clip-on supports + N, L1, L2, L3, PE, PEN labels	Linergy LGYE busbars connection kit spare part	Set of 12 flat plates with 2 studs + 24 torque nuts + 24 contact washers. The plates slide along the profile.	Set of 8 flat plates with 3 studs + 24 torque nuts + 24 contact washers. The plates slide along the profile.

M8 bolts		
		
Linergy BS, 20 bolts class 8.8	Characteristics	Set of 20 bolts + 20 nuts + 40 contact washers.
	Catalog numbers	LVS04782
		LVS04783
		LVS04784
		LVS04785
		LVS04786
		LVS04787
		LVS04788

Torque nuts		
		
20 M8 torque nuts	Characteristics	Can be used to obtain the correct tightening torque (28 Nm) recommended by the manufacturer, without using a torque wrench. Torque nuts may be used for all electrical connections.
	Catalog numbers	LVS04759

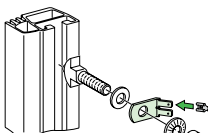
Voltage tap-offs		
		
20 Voltage tap-offs M10 pour 2 clips 6.35	Characteristics	For small lugs (on low-current cables or measurement tap-offs), insert a conducting washer (cat. no. LVS04775) between the busbar and the lug.
	Catalog numbers	LVS04229

 Connections on Linergy LGYE & LGY

InA (A)		Connecting to Linergy LGYE	Connecting to Linergy LGY
0 to 630	Cable - Insulated flexible bars	25 mm Linergy connection hardware used	25 mm Linergy connection hardware used
800 to 1250	5 mm bars	25 mm Linergy connection hardware used	25 mm Linergy connection hardware used
1600 to 2500	5 mm or 10 mm bars	Use of the 2 studs flat plate	39 mm Linergy connection hardware used
3200 to 4000	10 mm bars	Use of the 3 studs flat plate	-

Note: Jointing between 2 busbars (horizontal/vertical or horizontal/horizontal) must be mandatory done with studs plates.

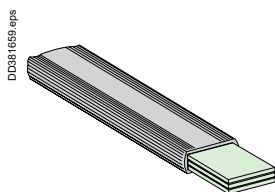

Secondary distribution

The insulated flexible bars are tested in a type-tested switchboard environment. Their design takes into account the switchboard architecture where they are often in close proximity to a protection device (circuit breaker or fuse) with significant heat losses.

The sizes for the flexible bars indicated below take into account the heat losses of Schneider Electric devices in a PrismaSeT switchboard.

Characteristics

Length	1800 mm
Rated insulation voltage (Ui)	1000 V
Maximum withstand temperature for the insulating material	125 C

Connection between device and busbars

The flexible bars are determined taking into account the connected device, whatever the internal temperature of the switchboard.

The bar sizes indicated below take into account the derating curves of devices.

Devices	Size (mm)	Catalog number
NSX100	20 x 2	LVS04742
NSX160/250	20 x 3 (1)	LVS04743
NSX400	32 x 5	LVS04751
NSX630	32 x 8 (2)	LVS04753
NSX100 ELCB	20 x 2	LVS04742
NSX160/250 ELCB	20 x 3 (1)	LVS04743
NSX400 ELCB	32 x 5	LVS04751
NSX630 ELCB	32 x 8 (2)	LVS04753
INS125/160	20 x 2	LVS04742
INS250	20 x 3	LVS04743
INS400	32 x 5	LVS04751
INS630	32 x 6	LVS04752
FM 200 A Linergy	20 x 3	LVS04743
FC 3P Linergy	32 x 8 (2) (3) (4)	LVS04753
FC 4P Linergy	32 x 8 (2) (3) (4)	LVS04753
Fupact 250	24 x 5	LVS04746
Fupact 400	32 x 5	LVS04751
Fupact 630	32 x 8 (2)	LVS04753
Easypact CVS100	20 x 2	LVS04742
Easypact CVS160/250	20 x 3 (1)	LVS04743
Easypact CVS400	32 x 5	LVS04751
Easypact CVS630	32 x 8 (2)	LVS04753

(1) To connect a ComPacT NSX250 and NSX150 ELCB to Linergy BW busbars, use a 24 x 5 mm flexible bar (LVS04746).

(2) The insulated flexible bars is not compatible with Form 2 partitioning (LVS04922). In this case, use the form 2 restoration kit LVS04924.

(3) In case of use of 32 x 6 insulated flexible bar, please contact Schneider Electric.

(4) Max length 500 mm per connection.



Functional Partitioning

Partitioning	H-2
Form 1 partitioning	H-3
Form 2 partitioning	H-4
Form 3b partitioning	H-6
Form 4 partitioning	H-7



PrismaSeT 6300 functional system

The forms according to IEC 61439-1&2

Decisions concerning the Form of separation and the degree of protection are the subject of an agreement between the manufacturer and the user.

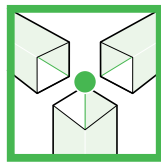

In most installations, PrismaSeT 6300 cubicles do not require partitioning. In this case, the switchboard is a Form 1.

Safety being one of its foremost goals, Schneider Electric offers options and features that go well beyond the recommendations of the standard.

The protection of life and property is a standard feature due to:

- front plates that require a tool to be removed
- keylocks on doors, some of which provide access to live parts
- the systematic installation of terminal shields on ComPacT NSX circuit breakers and ComPacT INS and INV switch-disconnectors
- covering of the upstream and downstream terminals on the incoming device so that operators are perfectly safe at all points in the switchboard when the incoming device is off (open).

What is more, PrismaSeT 6300 offers different levels of partitioning to create separations inside the cubicles and thus create Form 2b, 3b, 4a and 4b electrical switchboards. Electrical switchboards must meet the degree of protection IP2X to comply with standard IEC 61439-1&2.

Form 1

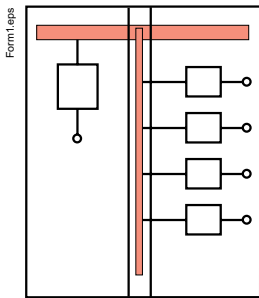

In most installations, PrismaSeT 6300 cubicles do not require partitioning. In this case, the switchboard is a Form 1. Safety being one of its foremost goals, Schneider Electric offers options and features that go well beyond the recommendations of the standard.

Form 2b

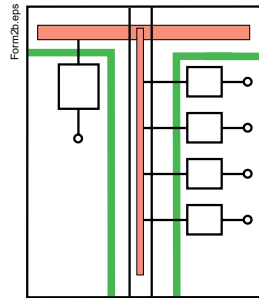

- Terminals for external conductors separated from busbars.
- The functional units and the terminals are separated from the busbars.

Form 3b *

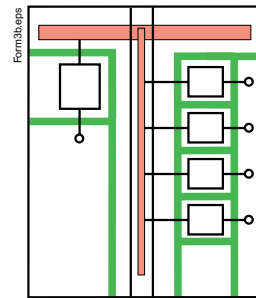

- Terminals for external conductors separated from busbars.
- The functional units are separated from each other and from the busbars.
- The terminals are separated from the busbars, but not from each other.

Form 4a *

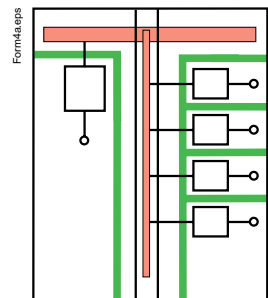

Terminals for external conductors in the same compartment as the associated functional unit.

Form 4b *

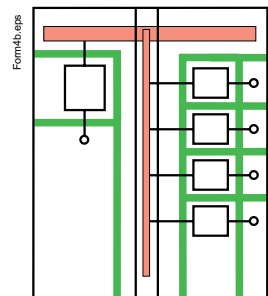

Terminals for external conductors not in the same compartment as the associated functional unit, but in individual, separate, enclosed protected spaces or compartments.

Note: * Is not included from 4000A to 6300A.



★ Presentation

Decisions concerning the Form of separation and the degree of protection are the subject of an agreement between the manufacturer and the user.

In most installations, PrismaSeT 6300 cubicles do not require partitioning. In this case, the switchboard is a Form 1. Safety being one of its foremost goals, Schneider Electric offers options and features that go well beyond the recommendations of the standard.

The protection of life and property is a standard feature due to:

- > front plates that require a tool to be removed
- > keylocks on doors, some of which provide access to live parts
- > the systematic installation of terminal shields on ComPacT NSX circuit breakers and ComPacT INS and INV switch-disconnectors.

What is more, PrismaSeT 6300 offers different levels of partitioning to create separations inside the cubicles and thus create Form 2b, 3b, 4a & 4b electrical switchboards.

Electrical switchboards must meet the degree of protection IP2X to comply with standard IEC 61439-1 and 2.

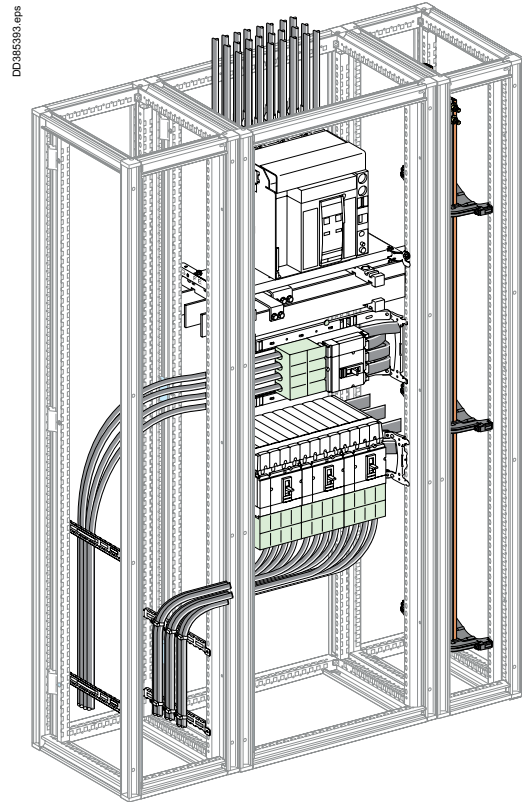

The protection of life and property is ensured by the systematic installation of terminal shields on ComPacT NSX circuit breakers and on ComPacT INS and INV switch-disconnectors (see the pages on the functional units).

Form 2 partitioning

Separation of busbars from the functional units:

- protection against contact with live parts upstream of the outgoing circuits
- protection against penetration of foreign solid bodies.

Lateral partitioning

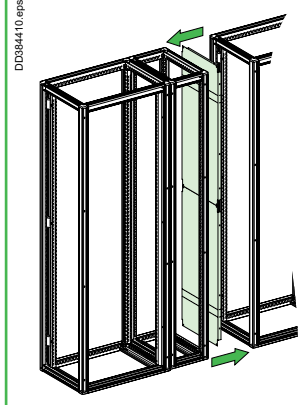
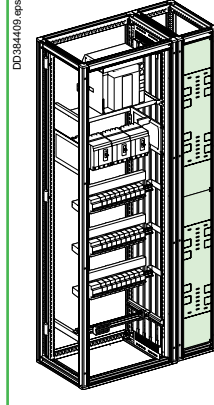
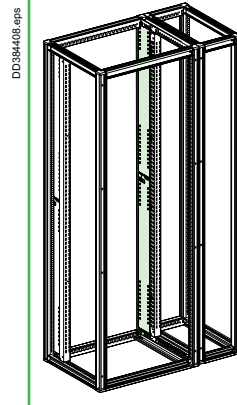
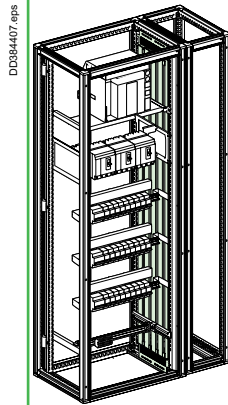

Schemes

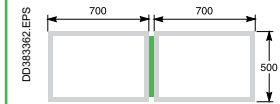
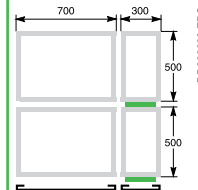
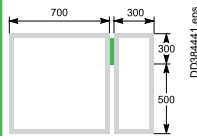
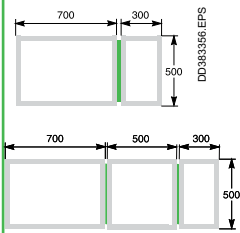

Characteristics	DD383356.EPS	DD384441.eps	DD383360.EPS	DD383362.EPS	
<p>Vertical barrier made of insulating slats.</p> <ul style="list-style-type: none"> ▪ Can be installed on both sides of Linergy and flat busbars. ▪ The space between the slats is sufficient for prefabricated connections (one copper bar, 5 or 10 mm thick, or insulated flexible bars) or for cables up to 35 mm², while maintaining the degree of protection IP2X compliance with standard IEC 60695.2.1 concerning withstand to fire. 	<ul style="list-style-type: none"> ▪ This kit enables passage of the connection between a device > 1600 A (NW, INS) and lateral vertical busbars. ▪ It is made up of an insulated plate (six modules H 300 mm) that can be cut as required, supplied with supports and the necessary hardware. 	<ul style="list-style-type: none"> ▪ For the PrismaSeT 6300 system switchboards 800 mm depth (500 + 300), a partitioning extension for 300 mm depth is required. 	<ul style="list-style-type: none"> ▪ Front protection is realized by the association of the door W300 and this barrier. Metallic barrier, composed of 2 parts H850, pre-cut at both ends. ▪ Rear protection, a barrier is required at the rear of the busbar compartment in cubicles that are 800, 1000 and 1300 mm deep. 	<ul style="list-style-type: none"> ▪ Metal partition, used to separate two adjacent cubicles. ▪ It is made up of two panels, each 850 mm high. ▪ The top and bottom ends have knock-outs for horizontal busbars. ▪ Supplied with the necessary supports and hardware, the partition is mounted on the framework and does not hinder installation of the functional mounting plates. 	
Cat. no.	D500: LVS06545	LVS04924	D800: LVS06543	W300: LVS06540 W500: LVS04990	D500: LVS06555 D800: LVS04911 + LVS06543 D800: LVS04979 (1)

(1) For W1200 and W500 enclosures.

Partitioning of horizontal busbars

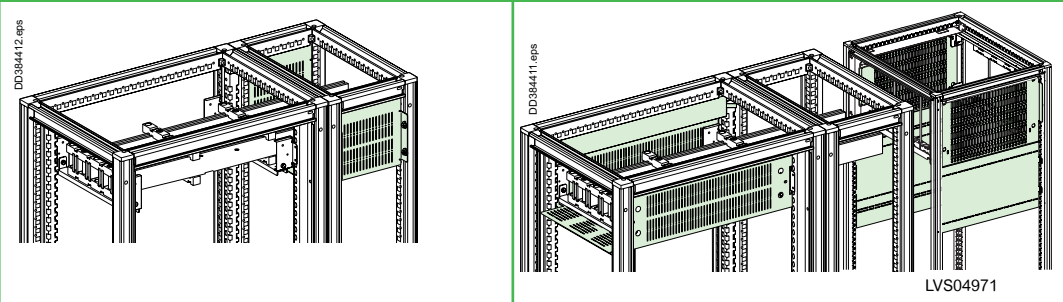

	W300		W700	
Designation	<ul style="list-style-type: none"> Set of two barriers (front and rear), plus a slotted rear panel for efficient natural convection in the switchboard. The set can be used to partition horizontal busbars installed at the top or bottom of the cubicle. The space required for the busbars is not increased. 			
For Depth	D500	D800	D500	D800
Cat. no. for 3M busbar	LVS06560	LVS06563	LVS06570	LVS06570
Cat. no. for 4M busbar	LVS06568	LVS06568	LVS06567	LVS06567
Cat. no. for 8M busbar	-	LVS04969	-	LVS04971 (1)

(1) Depending on circuit breaker connection to horizontal or vertical busbar, use the equivalent parts. For more details please refer to the detailed Instruction Sheet.
Note: when the busbars are at the bottom of the cubicle, gland plates are mandatory.

Partitioning of horizontal busbars

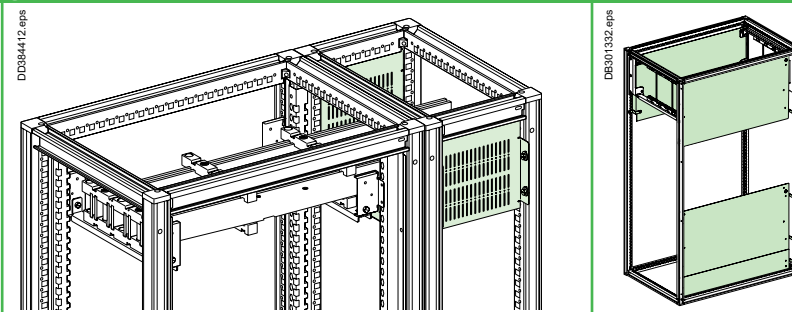

	W500		W1200	
Designation	<ul style="list-style-type: none"> Set of two barriers (front and rear), plus a slotted rear panel for efficient natural convection in the switchboard. The set can be used to partition horizontal busbars installed at the top or bottom of the cubicle. The space required for the busbars is not increased. 			
For Depth	D500	D800	D500	D800
Cat. no. for 8M busbar	-	LVS04970	-	LVS04972



Form 3b partitioning

Form partitioning

Form 3b partitioning

Separation of busbars from the functional units and separation of all functional units from one another.

Separation of the terminals for external conductors from the functional units, but not from each other.

- protection against contact with live parts
- reduction in the risk of faults between the functional units (propagation of electrical arcs, etc.).

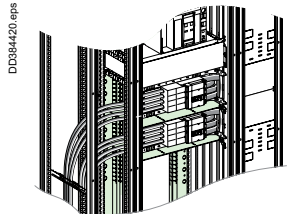
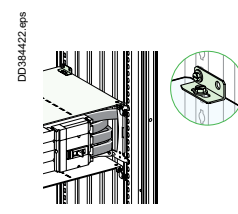
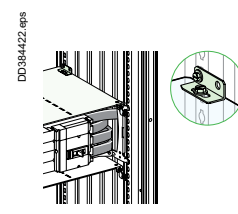
Front connection			
			
	Horizontal metal partition, W650 mm	Rear support for partitions, W650 mm	6 universal angle brackets
Characteristics	<ul style="list-style-type: none"> ▪ A horizontal metal partition can be used to physically separate functional units from one another. 	<ul style="list-style-type: none"> ▪ It is fixed at the rear by a support (two uprights) secured to the framework (500 mm deep) or to the intermediate uprights (800 mm deep frameworks). 	<ul style="list-style-type: none"> ▪ A set of brackets can be used to install partial Form 3 partitioning in the cubicle. ▪ It does not take up any useful space in the switchboard.
Cat. no.	LVS04901	LVS04943	LVS03583

Form 4 partitioning

- Separation of busbars from the functional units and separation of all functional units from one another, including the terminals for external conductors which are an integral part of the functional unit.
- Protection against contacts with live parts and reduction in the risk of faults between the functional units (propagation of electrical arcs, etc.).
- Form 4a: terminal for external conductors in the same compartment as the associated.
- Form 4b: Terminals for external conductors not in the same compartment as the associated functional unit, but in individual, separate, enclosed protected spaces or compartments.

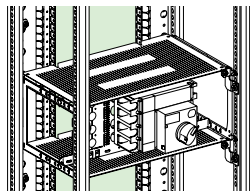
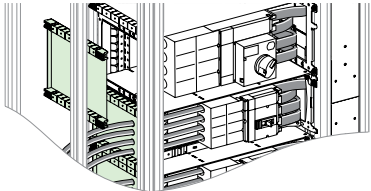
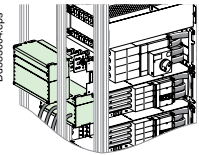
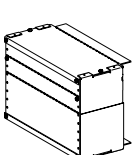
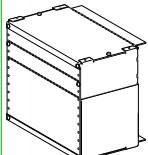
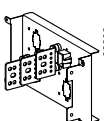
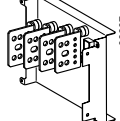
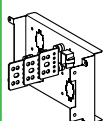
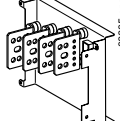
Form 4a partition								
For front connection								
								
	Form 4a backplate (one cat. no. per cubicle)		Form 4a gland plate					
Characteristics	<ul style="list-style-type: none"> ▪ A backplate (one cat. no. per cubicle) made up of two metal half panels mounted on the rear supports for Form 3 partitions. This backplate is not indispensable for 500 mm deep frameworks. 		<ul style="list-style-type: none"> ▪ A plastic gland plate that can be easily cut out (one for each functional unit) and is mounted on the framework. 					
Cat. no.	LVS04946		LVS04951		LVS04952			
Form 4b partition								
								
				Connection transfer assembly, 3 to 5 modules, 250 A	Connection transfer assembly, 4 to 6 modules, 630 A			
Characteristics	<ul style="list-style-type: none"> ▪ A cover with metallic gland plates that can be easily cut out on the side and bottom. It is available in two heights: 		<ul style="list-style-type: none"> ▪ Transfer assembly without connection to simplified the cable installation. 		<ul style="list-style-type: none"> ▪ Transfer assembly without connection to simplified the cable installation. 			
	3 to 5 modules		4 to 6 modules		3P	4P	3P	4P
Cat. no.	LVS06600		LVS06601		LVS06606	LVS06604	LVS06607	LVS06605



Additional Information

Additional information	I-2
After-sales accessories	I-2
Designing horizontal busbars - Linergy LGYE	I-3
Designing vertical busbars - Linergy LGY	I-4
Designing vertical busbars - Linergy LGYE	I-5
Drawout MasterPact 40-63	I-6
Connection of busbar trunking	I-7

Spare parts

SE Green Signature for RAL 7035 Enclosure

Plain sticker

DB301336.eps



PrismaSeT 6300 - SE Green signature for W300	NSYSFSEGS300
PrismaSeT 6300 - SE Green signature for W500	NSYSFSEGS500
PrismaSeT 6300 - SE Green signature for W700	NSYSFSEGS700
PrismaSeT 6300 - SE Green signature for W1200	NSYSFSEGS1200



Designing horizontal busbars

Linery LGYE

Electrical characteristics

Permissible current and selection of Linery LGYE busbars
Up to 6300 A

Linery LGYE section

Type of bars	Permissible current (A)											
	Ambient temperature around the switchboard											
	25 °C		30 °C		35 °C		40 °C		45 °C		50 °C	
Size per phase	IP ≤ 31	IP > 31	IP ≤ 31	IP > 31	IP ≤ 31	IP > 31	IP ≤ 31	IP > 31	IP ≤ 31	IP > 31	IP ≤ 31	IP > 31
Linery LGYE 630	680	580	650	550	630	530	590	500	550	470	520	•
Linery LGYE 800	860	740	830	710	800	680	750	630	700	600	660	•
Linery LGYE 1000	1080	920	1040	884	1000	850	940	790	880	750	830	•
Linery LGYE 1250	1350	1150	1300	1100	1250	1050	1170	1000	1100	930	1020	•
Linery LGYE 1600	1730	1580	1690	1530	1650	1480	1550	1380	1450	1300	1350	•
Linery LGYE 2000	2200	1810	2100	1730	2000	1650	1900	1560	1810	1480	1720	•
Linery LGYE 2500	2640	2230	2540	2160	2440	2100	2310	2000	2240	1930	2120	•
Linery LGYE 3200	3400	3020	3300	2900	3200	2800	3040	2660	2890	2520	2750	•
Linery LGYE 4000	3800	3510	3710	3430	3620	3350	3450	3180	3280	3020	3120	•
Linery LGYE 6300 *	5800	5490	5680	5370	5550	5250	5410	5120	5270	4990	5130	4860
Linery LGYE 6300 (Forced Ventilation)	•	6300	•	6300	•	6300	•	6300	•	**	•	**

• Connection impossible due to the operating-temperature limits of the devices installed in the switchboard.

Note: * No need to have fan for 500 and 300 mm cable duct.

** Ask to Schneider Electric.

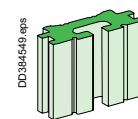
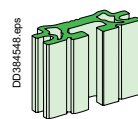
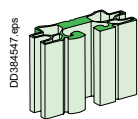
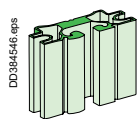
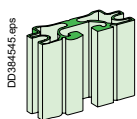

Section 630 A.
Cat. No. LVS04560.

Section 800 A.
Cat. No. LVS04561.

Section 1000 A.
Cat. No. LVS04562.

Section 1250 A.
Cat. No. LVS04563.

Section 1600 A.
Cat. No. LVS04564.

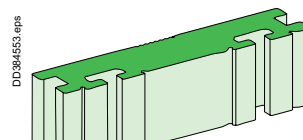
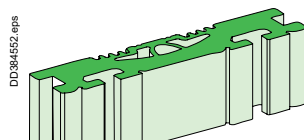
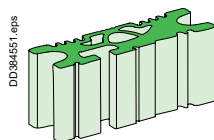
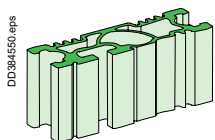

Section 2000 A.
Cat. No. LVS04565.

Section 2500 A.
Cat. No. LVS04566.

Section 3200 A.
Cat. No. LVS04567.

Section 4000 A.
Cat. No. LVS04568.

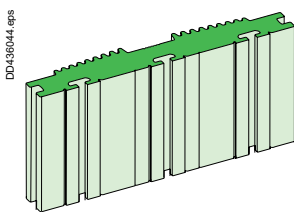

Section 6300 A.
Cat. No. LVS04582.



Designing vertical busbars

LinerGY LGY

Electrical characteristics

Permissible current and selection of Linergy LGY busbars

The goal is to optimise busbar size according to the installation and operating criteria.

Up to 3200 A

LinerGY LGY section

Type of bars	Permissible current (A)											
	Ambient temperature around the switchboard											
	25 °C		30 °C		35 °C		40 °C		45 °C		50 °C	
	IP ≤ 31	IP > 31	IP ≤ 31	IP > 31	IP ≤ 31	IP > 31	IP ≤ 31	IP > 31	IP ≤ 31	IP > 31	IP ≤ 31	IP > 31
LinerGY LGY 630	750	680	710	630	680	590	630	550	590	530	550	•
LinerGY LGY 800	920	840	880	800	840	760	800	720	760	680	720	•
LinerGY LGY 1000	1140	1040	1090	990	1040	950	990	900	950	850	900	•
LinerGY LGY 1250	1410	1290	1350	1230	1290	1170	1230	1100	1170	1050	1100	•
LinerGY LGY 1600	1800	1650	1720	1580	1650	1480	1580	1390	1480	1320	1390	•
LinerGY LGY 2000 (2 x 1000)	2200	2000	2100	1900	2000	1820	1900	1720	1820	1620	1720	•
LinerGY LGY 2500 (2 x 1250)	2740	2500	2620	2380	2500	2260	2380	2120	2260	2020	2120	•
LinerGY LGY 3200 (2 x 1600)	3480	3200	3340	3060	3200	2920	3060	2780	2920	2640	2780	•

• Connection impossible due to the operating-temperature limits of the devices installed in the switchboard.

Example: A Linergy LGY channelled bar can be used for a 1650 A current with an IP ≤ 31 and an ambient temperature around the switchboard of 35 °C.

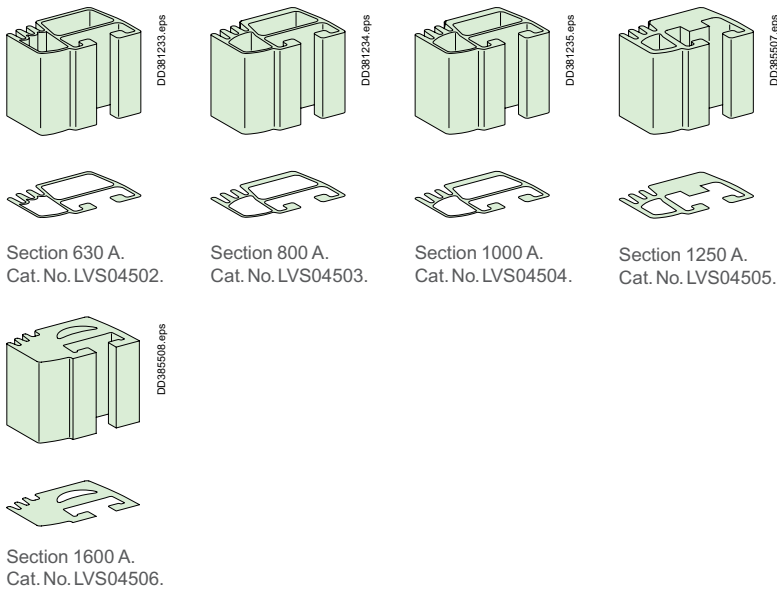

Note: the values indicated above have been validated for PrismaSeT 6300 switchboards.

Designing vertical busbars

Linerigy LGYE

Electrical characteristics

Permissible current and selection of Linerigy LGYE busbars

Up to 6300 A

Linerigy LGYE section

Type of bars	Permissible current (A)											
	Ambient temperature around the switchboard											
	25 °C		30 °C		35 °C		40 °C		45 °C		50 °C	
Size per phase	IP ≤ 31	IP > 31	IP ≤ 31	IP > 31	IP ≤ 31	IP > 31	IP ≤ 31	IP > 31	IP ≤ 31	IP > 31	IP ≤ 31	IP > 31
Linerigy LGYE 630	680	580	650	550	630	530	590	500	550	470	520	*
Linerigy LGYE 800	860	740	830	710	800	680	750	630	700	600	660	*
Linerigy LGYE 1000	1080	920	1040	884	1000	850	940	790	880	750	830	*
Linerigy LGYE 1250	1350	1150	1300	1100	1250	1050	1170	1000	1100	930	1020	*
Linerigy LGYE 1600	1730	1580	1690	1530	1650	1480	1550	1380	1450	1300	1350	*
Linerigy LGYE 2000	2200	1810	2100	1730	2000	1650	1900	1560	1810	1480	1720	*
Linerigy LGYE 2500	2640	2230	2540	2160	2440	2100	2310	2000	2240	1930	2120	*
Linerigy LGYE 3200	3400	3020	3300	2900	3200	2800	3040	2660	2890	2520	2750	*
Linerigy LGYE 4000	3800	3510	3710	3430	3620	3350	3450	3180	3280	3020	3120	*
Linerigy LGYE 6000	5800	5490	5680	5370	5550	5250	5410	5120	5270	4990	5130	4860

* Connection impossible due to the operating-temperature limits of the devices installed in the switchboard.

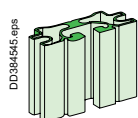

Section 630 A.
Cat. No. LVS04560.

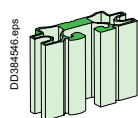

Section 800 A.
Cat. No. LVS04561.

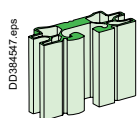

Section 1000 A.
Cat. No. LVS04562.

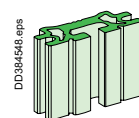

Section 1250 A.
Cat. No. LVS04563.

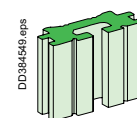

Section 1600 A.
Cat. No. LVS04564.

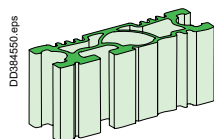

Section 2000 A.
Cat. No. LVS04565.

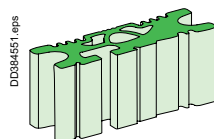

Section 2500 A.
Cat. No. LVS04566.

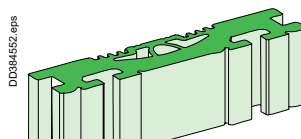

Section 3200 A.
Cat. No. LVS04567.

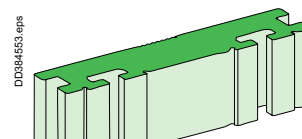

Section 4000 A.
Cat. No. LVS04568.

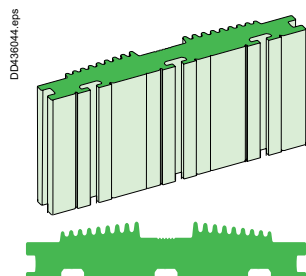

Section 6300 A.
Cat. No. LVS04582.



Designing connections between a device and busbars

Dedicated cubicle

Drawout MasterPacT 40-63

Electrical characteristics

Dedicated cubicle
 Linergy LGYE
 Connections drawings supplied by
 Schneider Electric

DD436023.ai

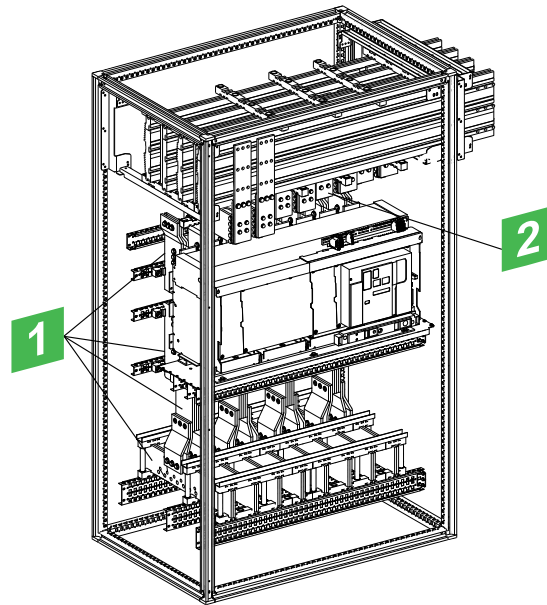

Connection

Flat bars, 10 mm thick

Device		Permissible current (A)											
		Ambient temperature around the switchboard											
		25 °C		30 °C		35 °C		40 °C		45 °C		50 °C	
		IP ≤ 31	IP > 31*	IP ≤ 31	IP > 31*	IP ≤ 31	IP > 31*	IP ≤ 31	IP > 31*	IP ≤ 31	IP > 31*	IP ≤ 31	IP > 31*
MTZ3 63/ NW63	Size per phase	4b 120x10(1)	4b 120x10(1)	4b 120x10(1)	4b 120x10(1)	4b 120x10(1)	4b 120x10(1)	4b 120x10(1)	4b 120x10(1)	4b 120x10(1)	4b 120x10(1)	4b 120x10(1)	4b 120x10(1)
		4b 80x10(2)	4b 80x10(2)	4b 80x10(2)	4b 80x10(2)	4b 80x10(2)	4b 80x10(2)	4b 80x10(2)	4b 80x10(2)	4b 80x10(2)	4b 80x10(2)	4b 80x10(2)	4b 80x10(2)
	I (A)	5450	6300	5325	6300	5200	6300	5025	6300	4825	6300	4650	6300
MTZ3 50/ NW50	Size per phase	4b 120x10(1)	4b 120x10(1)	4b 120x10(1)	4b 120x10(1)	4b 120x10(1)	4b 120x10(1)	4b 120x10(1)	4b 120x10(1)	4b 120x10(1)	4b 120x10(1)	4b 120x10(1)	4b 120x10(1)
		4b 80x10(2)	4b 80x10(2)	4b 80x10(2)	4b 80x10(2)	4b 80x10(2)	4b 80x10(2)	4b 80x10(2)	4b 80x10(2)	4b 80x10(2)	4b 80x10(2)	4b 80x10(2)	4b 80x10(2)
	I (A)	5000	5000	5000	5000	5000	5000	5000	5000	4825	5000	4650	5000
MTZ3 40/ NW40b	Size per phase	4b 120x10(1)	4b 120x10(1)	4b 120x10(1)	4b 120x10(1)	4b 120x10(1)	4b 120x10(1)	4b 120x10(1)	4b 120x10(1)	4b 120x10(1)	4b 120x10(1)	4b 120x10(1)	4b 120x10(1)
		4b 80x10(2)	4b 80x10(2)	4b 80x10(2)	4b 80x10(2)	4b 80x10(2)	4b 80x10(2)	4b 80x10(2)	4b 80x10(2)	4b 80x10(2)	4b 80x10(2)	4b 80x10(2)	4b 80x10(2)
	I (A)	4000	4000	4000	4000	4000	4000	4000	4000	4000	4000	4000	4000

Note: * Solution for IP>31 is with forced cooling. Please contact Schneider Electric for details.

Canalis connection

For Canalis connections, apply the appropriate derating coefficient K.

Device	NW40b	NW50	NW63
Derating coefficient K	1.0	0.98	0.95

Note: the values indicated above have been validated for PrismaSeT 6300 switchboards.



Practical information

PrismaSeT 6300 switchboards come equipped with a special interface that allows them to be directly connected to Canalis KT trunking. The electrical connection between the Canalis KT trunking and the PrismaSeT 6300 switchboard is just as easy to carry out as jointing between two busbar trunking sections.

The Canalis KT interface is totally integrated in the PrismaSeT 6300 switchboard volume.

It comprises a Canalis KT joint block and interface/circuit breaker connection terminals.

Trunking connection via the top

- Dismantle the roof.
- Cut out a passage for the busbar trunking.
- Adjust the guides according to the KT width that will be connected.
- Unscrew the junction block screws.
- Ensure that the busbar trunking length to be connected to the switchboard is correctly supported and that it is not resting on the interface.
- Lower the element until it is in contact with the interface frame, without bearing on it.
- Tighten the junction torque nuts. When the head breaks, the torque of 60 Nm has been reached.

⚠ In certain cases, it is recommended to only tighten the 2 middle nuts to 60 Nm and the 2 outer nuts to 10 Nm.

- A red plastic washer that is ejected when the head breaks provides visual evidence that the joint tightening operation has been carried out correctly.
- For dismantling or maintenance operations, a second head is available on the nut and can be retightened using a conventional torque wrench. The recommended tightening torque is then 60 Nm.
- Reassemble the roof.

Sealing kit

- In order to retain the original IP index, use the roof sealing kit ordered with the busbar trunking. This kit guarantees an IP52 degree of protection at the trunking passage.
- The kit is installed by cutting out the roof of the PrismaSeT 6300 switchboard. This cut-out, which is the same dimension for all Canalis KT busbar trunking ratings, is made using the template delivered with the sealing kit.

DD383919.eps

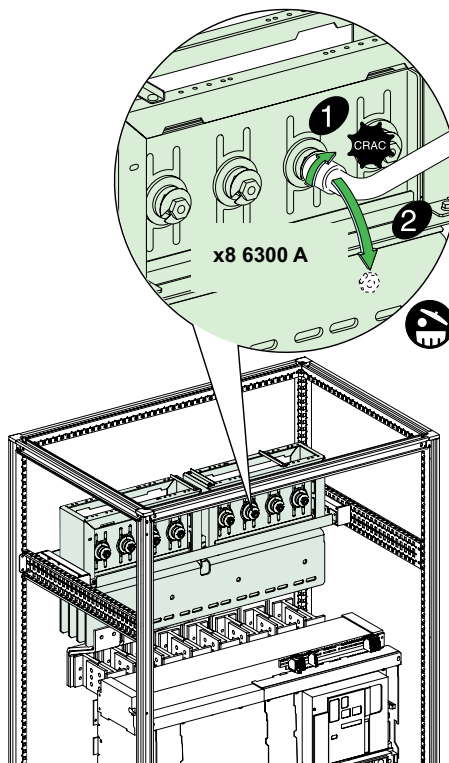

Life Is On

Schneider
Electric

Schneider Electric Industries SAS

35, rue Joseph Monier
CS 30323
92506 Rueil Malmaison Cedex
France

RCS Nanterre 954 503 439
Capital social 896 313 776
www.se.com

06-2025

© 2025 - Schneider Electric. All Rights Reserved.
All trademarks are owned by Schneider Electric Industries SAS or its affiliated companies.
Document reference: UEMKCAT008EN

This document has been
printed on recycled paper

