

Scheda dati

Specifiche



Testa pulsante luminoso - Ø22 - verde- per LED universale

ZB4BW133

Prezzo: 13,57 EUR

Presentazione

Gamma Prodotto	Harmony XB4
Tipo Prodotto	Testa pulsante luminoso
Nome Dispositivo	ZB4
Compatibilità Del Prodotto	Universal LED
Materiale testa	Metallo cromato
Tipo di testa	Standard
Diametro Di Montaggio	22,5 mm
Vendita quantità indivisibile	1
Forma della testa	Circolare
Tipo di operatore	ad impulso
Tipo operatore	Verde sporgente, non marcato
Info da operatore	Con gemma liscia
Colore capsula o gemma	Verde

Caratteristiche tecniche

Larghezza totale CAD	29 mm
Altezza totale CAD	29 mm
Profondità totale CAD	33 mm
Peso Netto	0,029 kg
Resistenza al lavaggio ad alta pressione	7000000 Pa a 55 °C, distanza: 0,1 m
Durata meccanica	10000000 cicli
Codice di composizione elettrico	M1 per <6 contattisingolo in Montaggio anteriore diretto sul pulsante con LED M2 per <6 contattisingolo e doppio in Montaggio anteriore diretto sul pulsante con LED M6 per <2 contattisingolo in Montaggio anteriore diretto sul pulsante con LED integrato e trasformatore M10 per <2 contattisingolo in Montaggio anteriore diretto sul pulsante con LED
Presentazione del dispositivo	Basic sub-assemblies

Ambiente

Trattamento di protezione	TH
Temperatura Di Stoccaggio	-40...70 °C
Temperatura Ambiente	-40...70 °C
Categoria di sovratensione	Classe I conforme a IEC 60536

Grado di protezione IP	IP66 conforme a CEI 60529 IP69 IP69K
Grado Di Protezione Nema	NEMA 13 NEMA 4X
Grado Di Protezione Ik	IK05 conforme a CEI 62262
Norme Di Riferimento	IEC 60947-5-5 JIS C8201-5-1 IEC 60947-5-4 CSA C22.2 No 14 IEC 60947-1 UL 508 IEC 60947-5-1 JIS C8201-1
Certificazioni Prodotto	CSA LROS (Lloyds Register of shipping) BV UL listed / CSA DNV
Resistenza alle vibrazioni	5 gn (f= 2...500 Hz) conforming to IEC 60068-2-6
Resistenza agli urti	30 gn (durata = 18 ms) per accelerazione a mezza onda sinusoidale conforme a IEC 60068-2-27 50 gn (durata = 11 ms) per accelerazione a mezza onda sinusoidale conforme a IEC 60068-2-27

Confezionamenti

Unità di misura confezione 1	PCE
Num.unità in pkg.	1
Confezione 1: altezza	3,5 cm
Confezione 1: larghezza	4,8 cm
Confezione 1: profondità	5,5 cm
Peso imballo (Kg)	29,0 g
Unità di misura confezione 2	S03
Numero di unità per confezione 2	300
Confezione 2: altezza	30 cm
Confezione 2: larghezza	30 cm
Confezione 2: profondità	40 cm
Confezione 2: peso	9,293 kg

Garanzia contrattuale

Garanzia (in mesi)	18
---------------------------	----

Environmental Data

L'obiettivo di Schneider Electric è raggiungere lo status di Net Zero entro il 2050 attraverso partnership nella supply chain, materiali a basso impatto e circolarità, grazie alla nostra campagna "Use Better, Use Longer, Use Again" (Usa meglio, usa più a lungo, utilizza di nuovo), per prolungare la durata dei prodotti e la riciclabilità.

[Spiegazione dei Environmental Data >](#)

[Come valutiamo la sostenibilità dei prodotti >](#)

Impronta ambientale

Impronta di carbonio totale del ciclo di vita 1

Informazioni ambientali [Profilo ambientale del prodotto](#)

Use Better

Materiali e imballaggio

Confezione di cartone riciclato Si

Imballaggio senza plastica Si

[Direttiva RoHS UE](#)

Conformità proattiva (prodotto al di fuori dell'ambito legale di RoHS Unione europea)

Regolamento REACH

[Dichiarazione REACH](#)

Use Again

Reimballaggio e rifabbricazione

Profilo di circolarità [Informazioni sulla fine della vita](#)

Ritiro del prodotto Si

Dimensions Drawings

Dimensions

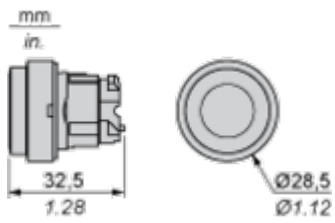

Mounting and Clearance

Panel Cut-out for Pushbuttons, Switches and Pilot Lights (Finished Holes, Ready for Installation)

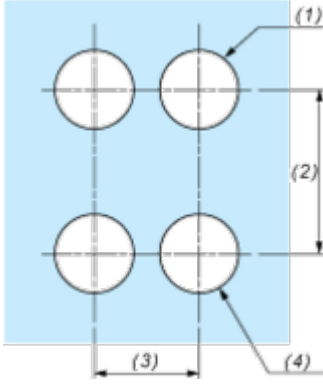
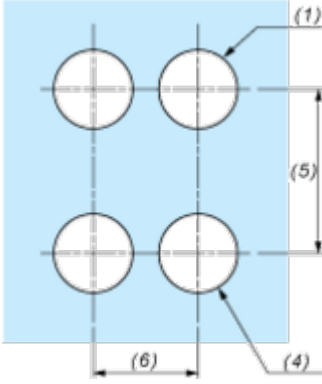
Connection by Screw Clamp Terminals or Plug-in Connectors or on Printed Circuit Board	Connection by Faston Connectors
	
<p>(1) Diameter on finished panel or support (2) 40 mm min. / 1.57 in. min. (3) 30 mm min. / 1.18 in. min. (4) $\varnothing 22.5 \text{ mm} / 0.89 \text{ in. recommended } (\varnothing 22.3 \text{ mm }_0^{+0.4} / 0.88 \text{ in. }_0^{+0.016})$ (5) 45 mm min. / 1.78 in. min. (6) 32 mm min. / 1.26 in. min.</p>	

Pushbuttons, Switches and Pilot Lights for Printed Circuit Board Connection

Panel Cut-outs (Viewed from Installer's Side)

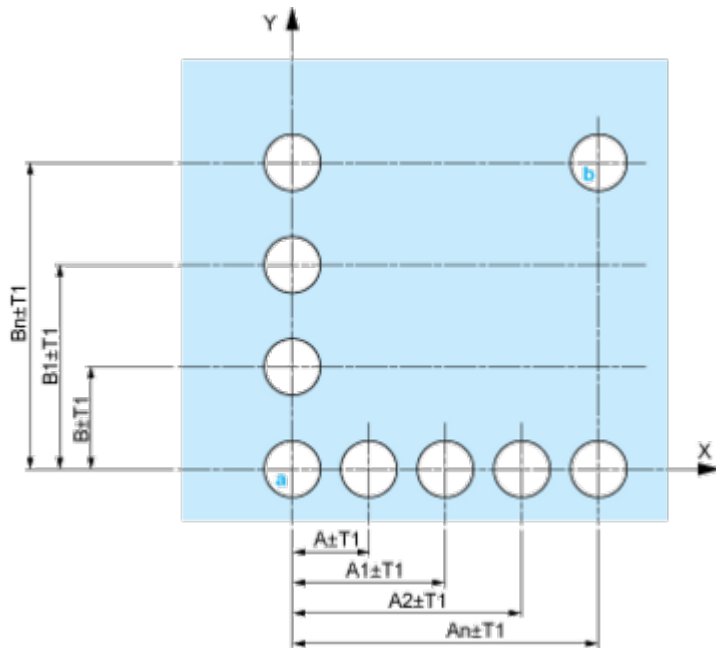

A: 30 mm min. / 1.18 in. min.

B: 40 mm min. / 1.57 in. min.

Printed Circuit Board Cut-outs (Viewed from Electrical Block Side)

Dimensions in mm

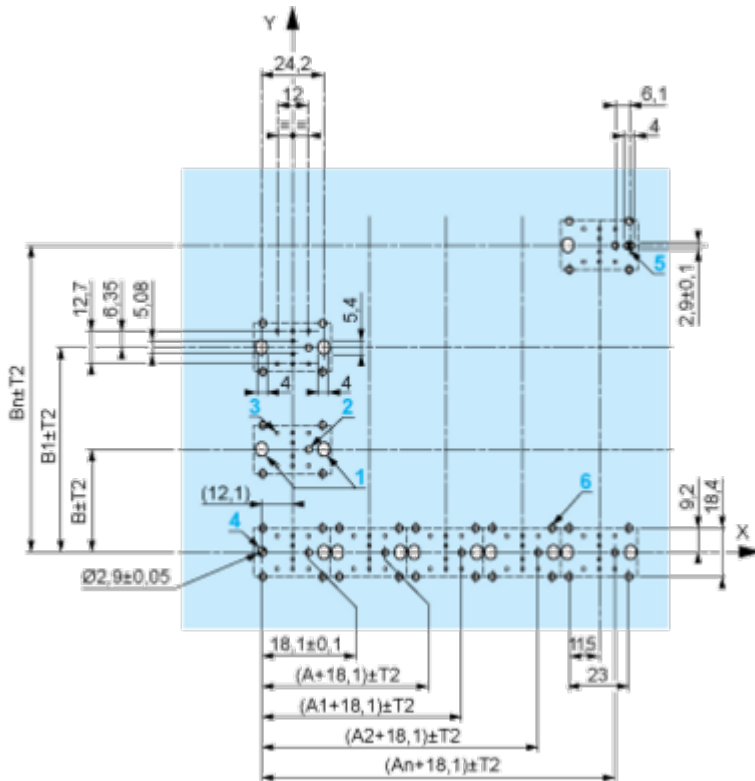

A: 30 mm min.

B: 40 mm min.

Dimensions in in.



A: 1.18 in. min.
 B: 1.57 in. min.

General Tolerances of the Panel and Printed Circuit Board

The cumulative tolerance must not exceed 0.3 mm / 0.012 in: T1 + T2 = 0.3 mm max.

Installation Precautions

- Minimum thickness of circuit board: 1.6 mm / 0.06 in.
- Cut-out diameter: 22.4 mm ± 0.1 / 0.88 in. ± 0.004
- Orientation of body/fixing collar ZB4 BZ009: ± 2° 30' (excluding cut-outs marked a and b).
- Tightening torque of screws ZBZ 006: 0.6 N.m (5.3 lbf.in) max.
- Allow for one ZB4 BZ079 fixing collar/pillar and its fixing screws:
 - every 90 mm / 3.54 in. horizontally (X), and 120 mm / 4.72 in. vertically (Y).
 - with each selector switch head (ZB4 BD*, ZB4 BJ*, ZB4 BG*).

The fixing centers marked a and b are diagonally opposed and must align with those marked 4 and 5.



(1) Panel

(2) Printed circuit board

Mounting of Adapter (Socket) ZBZ 01•

- 1 2 elongated holes for ZBZ 006 screw access
- 2 1 hole \varnothing 2.4 mm \pm 0.05 / 0.09 in. \pm 0.002 for centring adapter ZBZ 01•
- 3 8 \times \varnothing 1.2 mm / 0.05 in. holes
- 4 1 hole \varnothing 2.9 mm \pm 0.05 / 0.11 in. \pm 0.002, for aligning the printed circuit board (with cut-out marked a)
- 5 1 elongated hole for aligning the printed circuit board (with cut-out marked b)
- 6 4 holes \varnothing 2.4 mm / 0.09 in. for clipping in adapter ZBZ 01•

Dimensions An + 18.1 relate to the \varnothing 2.4 mm \pm 0.05 / 0.09 in. \pm 0.002 holes for centring adapter ZBZ 01•.

Technical Description

Electrical Composition Corresponding to Codes M1 and M7

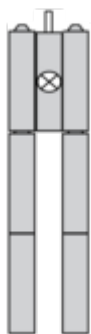

Electrical Composition Corresponding to Codes M2 and M8



Electrical Composition Corresponding to Codes M6 and P2

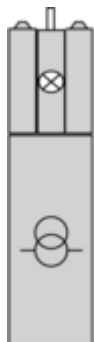

Electrical Composition Corresponding to Codes M5, M10, MF1, MR1 and MF2

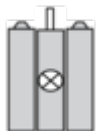

Legend

Single contact



Double contact



Light block



Possible location



Technical Illustration

Dimensions

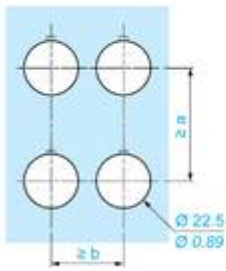
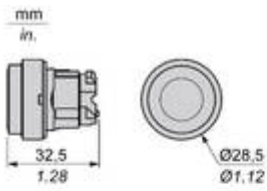

		a (mm)	a (in.)	b (mm)	b (in.)
		40	1.57	30	1.18
ZBE.....	ZBV.....				
		45	1.77	32	1.26
ZBE.....3	ZBV.....3				
		40	1.57	30	1.18
ZBE.....4	ZBV.....4				
		50	1.97	30	1.18
ZBE.....5	ZBV.....5				
		40	1.57	30	1.18
ZBE.....9	ZBV.....9				
		40	1.57	30	1.18
ZBRT•	ZBRV1				

Offer Marketing Illustration

Product benefits / Features

Caratteristiche

Harmony XB4/XB5 Funzioni Luminose



- NUOVO LED universale per tutti i colori
- Semplice scelta e tempi di installazione ridotti
- Semplificazione della gestione del magazzino
- Miglioramento dell'intensità e della luminosità del colore



Offer Marketing Illustration

Product benefits / Features

Vantaggi tecnici

Harmony XB4 (pulsanti)

Conformità a IEC, UL, CSA, CCC, EAC, CE, norme JIS e certificazioni marine

Grado di protezione IP66, 67, 69, 69K, type 4X

Elevata resistenza alle vibrazioni con viti di serraggio anti-svitamento



Temperatura di funzionamento da -40°C a +70°C

Livello di protezione agli urti meccanici fino a IK06

Commutazione sicura per comandi diretti di carichi in DC induttivi o pesanti: 100.000 manovre a 10 A, 24 V DC

Offer Marketing Illustration

Product benefits / Features

Caratteristiche Harmony XB4 (pulsanti)



- 

Montaggio e smontaggio facile e veloce
- 

Ottimo collegamento meccanico con testa operatore
- 

Differneti tipi di collegamento: morsetto a vite, connettore, Faston, morsetto a molla o su circuito stampato
- 

Un ampio set di accessori per personalizzare i tuoi pannelli di comando
- 

Robustezza per resistere ad ambienti difficili

Offer Marketing Illustration

Product benefits / Features

Technical Benefits

Harmony XB4

Conformity with IEC, UL, CSA, CCC EAC, and JIS standards, as well as CE marking and marine approvals

Up to IP66, 67, 69, 69K, and type 4X protection ratings

High vibration resistance with shake-proof terminal screws



Operating temperature from -40°C to 70°C

Shock protection level up to IK06

Secure switching of inductive or heavy DC loads directly – 100 000 operations at 10A, 24V dc

Image of product / Alternate images

Alternative

