

Scheda dati

Specifiche



Testa selettore a chiave Ø 22 - 2 posizioni - Ronis 458a - estraz.chiave sx

ZB4BG610

Prezzo: 45,45 EUR

Presentazione

Gamma Prodotto	Harmony XB4
Tipo Prodotto	Testa per selettore a chiave
Nome Dispositivo	ZB4
Materiale testa	Metallo cromato
Diametro Di Montaggio	22 mm
Tipo di testa	Standard
Vendita quantità indivisibile	1
Forma della testa	Circolare
Ritorno	Da destra verso sinistra
Tipo operatore	Nero selettore a chiave
Tipo di operatore	Ad impulso
Informazioni posizione operatore	2 posizioni 90°
Tipo Di Serratura	Key 458A
Posizione di estrazione chiave	Sinistra

Caratteristiche tecniche

Larghezza totale CAD	29 mm
Altezza totale CAD	29 mm
Profondità totale CAD	72 mm
Peso Netto	0,098 kg
Resistenza al lavaggio ad alta pressione	7000000 Pa a 55 °C, distanza: 0,1 m
Durata meccanica	1000000 cicli
Codice di composizione elettrico	C3 per <6 contattisingolo in Montaggio anteriore diretto sul pulsante C4 per <6 contattisingolo e doppio in Montaggio anteriore diretto sul pulsante C5 per <5 contattisingolo in Montaggio anteriore diretto sul pulsante C6 per <5 contattisingolo e doppio in Montaggio anteriore diretto sul pulsante C7 per <4 contattisingolo in Montaggio anteriore diretto sul pulsante C8 per <4 contattisingolo e doppio in Montaggio anteriore diretto sul pulsante C11 per <3 contattisingolo in Montaggio anteriore diretto sul pulsante C15 per <1 contattisingolo in Montaggio anteriore diretto sul pulsante
Presentazione del dispositivo	Prodotti base

Ambiente

Trattamento di protezione	TH
Temperatura Di Stoccaggio	-40...70 °C

Temperatura Ambiente	-40...70 °C
Categoria di sovratensione	Classe I conforme a IEC 60536
Grado di protezione IP	IP66 conforme a CEI 60529 IP67 IP69 IP69K
Grado Di Protezione Nema	NEMA 13 NEMA 4X
Norme Di Riferimento	UL 508 EN/IEC 60947-1 CSA C22.2 No 14 EN/IEC 60947-5-1 EN/IEC 60947-5-4 EN/IEC 60947-5-5 GB 14048.5
Certificazioni Prodotto	CSA DNV BV LROS (Lloyds Register of shipping) UL listed / CSA
Resistenza alle vibrazioni	5 gn (f= 2...500 Hz) conforming to IEC 60068-2-6
Resistenza agli urti	30 gn (durata = 18 ms) per accelerazione a mezza onda sinusoidale conforme a IEC 60068-2-27 50 gn (durata = 11 ms) per accelerazione a mezza onda sinusoidale conforme a IEC 60068-2-27

Confezionamenti

Unità di misura confezione 1	PCE
Num.unità in pkg.	1
Confezione 1: altezza	5,334 cm
Confezione 1: larghezza	3,556 cm
Confezione 1: profondità	8,636 cm
Peso imballo (Kg)	104,327 g
Unità di misura confezione 2	S03
Numero di unità per confezione 2	100
Confezione 2: altezza	30 cm
Confezione 2: larghezza	30 cm
Confezione 2: profondità	40 cm
Confezione 2: peso	11,1 kg

Garanzia contrattuale

Garanzia (in mesi)	18
---------------------------	----

Environmental Data

L'obiettivo di Schneider Electric è raggiungere lo status di Net Zero entro il 2050 attraverso partnership nella supply chain, materiali a basso impatto e circolarità, grazie alla nostra campagna "Use Better, Use Longer, Use Again" (Usa meglio, usa più a lungo, utilizza di nuovo), per prolungare la durata dei prodotti e la riciclabilità.

[Spiegazione dei Environmental Data](#) >

[Come valutiamo la sostenibilità dei prodotti](#) >

Impronta ambientale

Impronta di carbonio totale del ciclo di vita 1

Informazioni ambientali [Profilo ambientale del prodotto](#)

Use Better

Materiali e imballaggio

Confezione di cartone riciclato No

Imballaggio senza plastica No

[Direttiva RoHS UE](#)

Conformità proattiva (prodotto al di fuori dell'ambito legale di RoHS Unione europea)

Numero SCIP F28cb399-1b6a-409d-ac7b-4169e47b25c8

Regolamento REACH [Dichiarazione REACH](#)

Use Again

Reimballaggio e rifabbricazione

Profilo di circolarità [Informazioni sulla fine della vita](#)

Ritiro del prodotto Sì

Dimensions Drawings

Dimensions

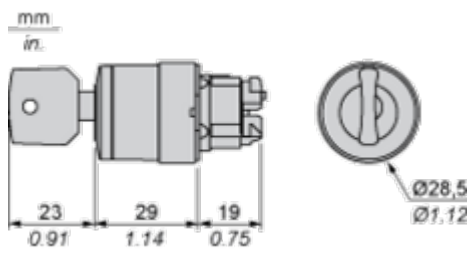

Mounting and Clearance

Panel Cut-out for Pushbuttons, Switches and Pilot Lights (Finished Holes, Ready for Installation)

Connection by Screw Clamp Terminals or Plug-in Connectors or on Printed Circuit Board	Connection by Faston Connectors
	
<p>(1) Diameter on finished panel or support (2) 40 mm min. / 1.57 in. min. (3) 30 mm min. / 1.18 in. min. (4) $\varnothing 22.5 \text{ mm} / 0.89 \text{ in. recommended } (\varnothing 22.3 \text{ mm }_0^{+0.4} / 0.88 \text{ in. }_0^{+0.016})$ (5) 45 mm min. / 1.78 in. min. (6) 32 mm min. / 1.26 in. min.</p>	



A: 1.18 in. min.
 B: 1.57 in. min.

General Tolerances of the Panel and Printed Circuit Board

The cumulative tolerance must not exceed 0.3 mm / 0.012 in: T1 + T2 = 0.3 mm max.

Installation Precautions

- Minimum thickness of circuit board: 1.6 mm / 0.06 in.
- Cut-out diameter: 22.4 mm ± 0.1 / 0.88 in. ± 0.004
- Orientation of body/fixing collar ZB4 BZ009: ± 2° 30' (excluding cut-outs marked a and b).
- Tightening torque of screws ZBZ 006: 0.6 N.m (5.3 lbf.in) max.
- Allow for one ZB4 BZ079 fixing collar/pillar and its fixing screws:
 - every 90 mm / 3.54 in. horizontally (X), and 120 mm / 4.72 in. vertically (Y).
 - with each selector switch head (ZB4 BD*, ZB4 BJ*, ZB4 BG*).

The fixing centers marked a and b are diagonally opposed and must align with those marked 4 and 5.

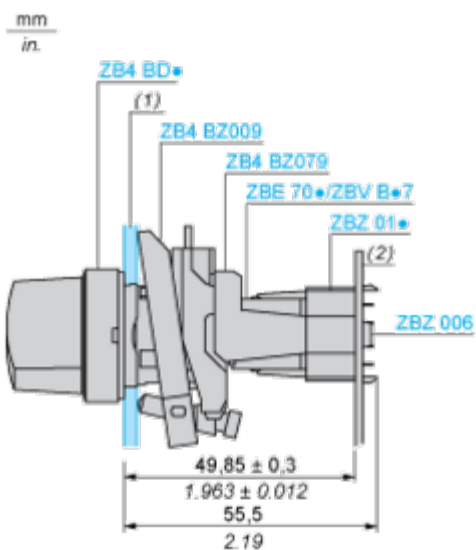

(1) Panel

(2) Printed circuit board

Mounting of Adapter (Socket) ZBZ 01•

- 1 2 elongated holes for ZBZ 006 screw access
- 2 1 hole \varnothing 2.4 mm \pm 0.05 / 0.09 in. \pm 0.002 for centring adapter ZBZ 01•
- 3 8 \times \varnothing 1.2 mm / 0.05 in. holes
- 4 1 hole \varnothing 2.9 mm \pm 0.05 / 0.11 in. \pm 0.002, for aligning the printed circuit board (with cut-out marked a)
- 5 1 elongated hole for aligning the printed circuit board (with cut-out marked b)
- 6 4 holes \varnothing 2.4 mm / 0.09 in. for clipping in adapter ZBZ 01•

Dimensions An + 18.1 relate to the \varnothing 2.4 mm \pm 0.05 / 0.09 in. \pm 0.002 holes for centring adapter ZBZ 01•.

Technical Description

Electrical Composition Corresponding to Code C3

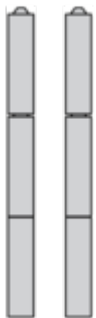

Electrical Composition Corresponding to Code C4



Electrical Composition Corresponding to Code C5

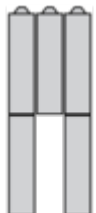

Electrical Composition Corresponding to Code C6



Electrical Composition Corresponding to Code C7

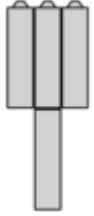

Electrical Composition Corresponding to Code C8



Electrical Composition Corresponding to Codes C9, C11, SF1 and SR1



Electrical Composition Corresponding to Code C15

1 N/O



1 N/C



1 N/O + N/C or 1 N/O + N/O or 1 N/C + N/C



Legend

Single contact



Double contact



Light block







Possible location



Sequence of Contacts Fitted to 2-position Selector Switch Body

Position 315°



Push	Position	Top			
		Bottom			
	Location		Left	Centre	Right
	State		0	0	0
	Contacts		N/O	open	open
		N/C	closed	closed	closed

Position 45°



Push	Position	Top			
		Bottom			
	Location		Left	Centre	Right
	State		1	1	1
Contacts		N/O	closed	closed	closed
		N/C	open	open	open

Technical Illustration

Dimensions

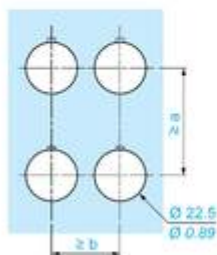
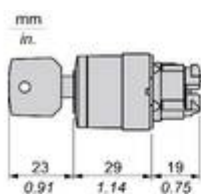

		a (mm)	a (in.)	b (mm)	b (in.)
		40	1.57	30	1.18
ZBE.....	ZBV.....				
		45	1.77	32	1.26
ZBE.....3	ZBV.....3				
		40	1.57	30	1.18
ZBE.....4	ZBV.....4				
		50	1.97	30	1.18
ZBE.....5	ZBV.....5				
		40	1.57	30	1.18
ZBE.....9	ZBV.....9				
		40	1.57	30	1.18
ZBRT•	ZBRV1				

Offer Marketing Illustration

Product benefits / Features

Vantaggi tecnici

Harmony XB4 (pulsanti)

Conformità a IEC, UL, CSA, CCC, EAC, CE, norme JIS e certificazioni marine

Grado di protezione IP66, 67, 69, 69K, type 4X

Elevata resistenza alle vibrazioni con viti di serraggio anti-svitamento



Temperatura di funzionamento da -40°C a +70°C

Livello di protezione agli urti meccanici fino a IK06

Commutazione sicura per comandi diretti di carichi in DC induttivi o pesanti: 100.000 manovre a 10 A, 24 V DC

Offer Marketing Illustration

Product benefits / Features

Caratteristiche Harmony XB4 (pulsanti)



- 

Montaggio e smontaggio facile e veloce
- 

Ottimo collegamento meccanico con testa operatore
- 

Differneti tipi di collegamento: morsetto a vite, connettore, Faston, morsetto a molla o su circuito stampato
- 

Un ampio set di accessori per personalizzare i tuoi pannelli di comando
- 

Robustezza per resistere ad ambienti difficili

Offer Marketing Illustration

Product benefits / Features

Technical Benefits

Harmony XB4

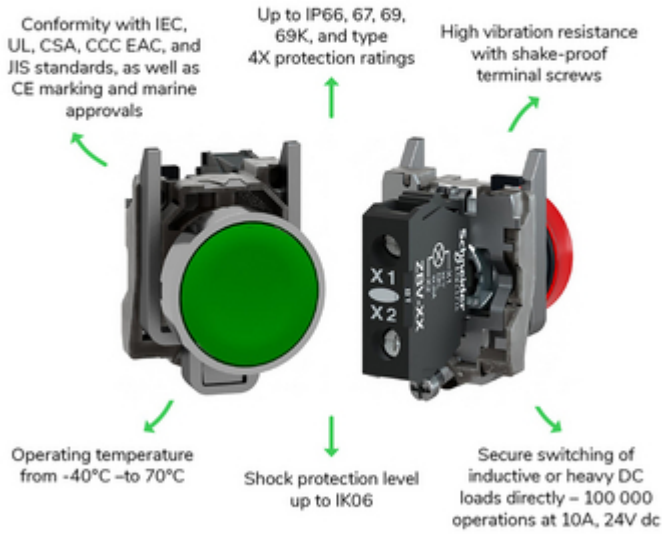

Image of product / Alternate images

Alternative

