

Scheda dati

Specifiche



Interruttore automatico magnetotermico a pulsanti, TeSys, GV2ME, 0,1-0,16A molla

GV2ME013

Prezzo: 91,05 EUR

Presentazione

Gamma	TeSys Deca
Nome Prodotto	TeSys GV2
Tipo Prodotto	Interruttore automatico
Nome Dispositivo	GV2ME
Applicazione	Protezione motore
Tecnologia sganciatore	Magnetotermico

Caratteristiche tecniche

Numero di poli	3P
Tipo di rete	CA
Categoria di utilizzazione	Categoria A conforme a IEC 60947-2 AC-3 conforme a IEC 60947-4-1 AC-3e conforme a IEC 60947-4-1
Frequenza di rete	50/60 Hz conforme a IEC 60947-2
Potere di interruzione	100 kA Icu conforme a IEC 60947-2 a 230/240 V CA 50/60 Hz 100 kA Icu conforme a IEC 60947-2 a 400/415 V CA 50/60 Hz 100 kA Icu conforme a IEC 60947-2 a 440 V CA 50/60 Hz 100 kA Icu conforme a IEC 60947-2 a 500 V CA 50/60 Hz 100 kA Icu conforme a IEC 60947-2 a 690 V CA 50/60 Hz
Potere di interruzione di servizio nominale [Ics]	100 % conforme a IEC 60947-2 a 230/240 V CA 50/60 Hz 100 % conforme a IEC 60947-2 a 400/415 V CA 50/60 Hz 100 % conforme a IEC 60947-2 a 440 V CA 50/60 Hz 100 % conforme a IEC 60947-2 a 500 V CA 50/60 Hz 100 % conforme a IEC 60947-2 a 690 V CA 50/60 Hz
Tipo di controllo	Pulsante
Corrente nominale [In]	0,16 A
campo di regolazione protezione termica	0,1...0,16 A conforme a IEC 60947-2
Corrente di sgancio magnetico	1,93 A
Corrente termica convenzionale in aria [Ith]	0,16 A conforme a IEC 60947-2
Tensione nominale di impiego [Ue]	690 V CA 50/60 Hz conforme a IEC 60947-2
Tensione nominale di isolamento [Ui]	690 V CA 50/60 Hz conforme a IEC 60947-2
Tensione nominale di tenuta agli impulsi [Uimp]	6 kV conforme a IEC 60947-2
Sensibilità mancanza di fase	Si conforme a IEC 60947-4-1
Attitudine all'isolamento	Si conforme a IEC 60947-1
Dissipazione energia per polo	2,5 W

Durata meccanica	100000 cicli
Durata elettrica	100000 cicli per AC-3 a 415 V In 100000 cicli per AC-3e a 415 V In
Servizio nominale	Ininterrotto conforme a IEC 60947-4-1
Connessioni - morsetti	Circuito di potenza: terminali a molla 2 cavi 1...6 mm ² solido Circuito di potenza: terminali a molla 2 cavi 1,5...4 mm ² flessibile senza terminazione cavo Circuito di potenza: terminali a molla 2 cavi 1...4 mm ² flessibile con terminazione cavo
Tipologia fissaggio	Guida DIN simmetrica 35 mm: agganciato Pannello: avvitato (con piastra di adattamento)
Posizione Di Montaggio	Orizzontale Verticale
Larghezza	45 mm
Altezza	101 mm
Profondità	78,5 mm
Peso Netto	0,28 kg
Colore	Grigio scuro

Ambiente

norme di riferimento	EN/IEC 60947-2 EN/IEC 60947-4-1 UL 60947-4-1 CSA C22.2 No 60947-4-1 IEC/EN 60335-2-40:Annex JJ IEC/EN 60335-1:Clause 30.2
Certificazioni Prodotto	CCC UL CSA EAC ATEX LROS (Lloyds Register of shipping) BV RINA DNV-GL UKCA
Grado di protezione IK	IK04
Grado Di Protezione Ip	IP20 conforme a CEI 60529
tenuta climatica	conforme a IACS E10
Temperatura Di Stoccaggio	-40...80 °C
Resistenza Al Fuoco	960 °C conforme a IEC 60695-2-11
Temperatura Ambiente	-20...60 °C
Robustezza meccanica	Urti: 30 Gn per 11 ms Vibrazioni: 5 gn, 5...150 Hz
Altitudine di funzionamento	= 2000 m

Confezionamenti

Unità di misura confezione 1	PCE
Num.unità in pkg.	1
Confezione 1: altezza	5,6 cm
Confezione 1: larghezza	8,5 cm
Confezione 1: profondità	11,1 cm

Peso imballo (Kg)	268,0 g
Unità di misura confezione 2	S02
Numero di unità per confezione 2	20
Confezione 2: altezza	15,0 cm
Confezione 2: larghezza	30,0 cm
Confezione 2: profondità	40,0 cm
Confezione 2: peso	5,73 kg

Garanzia contrattuale

Garanzia (in mesi)	18
---------------------------	----

Environmental Data

L'obiettivo di Schneider Electric è raggiungere lo status di Net Zero entro il 2050 attraverso partnership nella supply chain, materiali a basso impatto e circolarità, grazie alla nostra campagna "Use Better, Use Longer, Use Again" (Usa meglio, usa più a lungo, utilizza di nuovo), per prolungare la durata dei prodotti e la riciclabilità.

[Spiegazione dei Environmental Data](#) >

[Come valutiamo la sostenibilità dei prodotti](#) >

Impronta ambientale

Impronta di carbonio totale del ciclo di vita	43
---	----

Use Better

Materiali e imballaggio

Confezione di cartone riciclato	Sì
---------------------------------	----

Imballaggio senza plastica	Sì
----------------------------	----

Direttiva RoHS UE	Conforme alle esenzioni
-----------------------------------	-------------------------

Numero SCIP	04104e70-ba29-493c-b2cc-b5837d1f879b
-------------	--------------------------------------

Regolamento REACH	Dichiarazione REACH
-------------------	-------------------------------------

Use Again

Reimballaggio e rifabbricazione

Profilo di circolarità	Informazioni sulla fine della vita
------------------------	--

Ritiro del prodotto	No
---------------------	----

Etichetta RAEE	 Nei mercati dell'Unione Europea il prodotto deve essere smaltito in base a un metodo differenziato specifico e non tra i normali rifiuti.
----------------	---

Performance Curves

Thermal-Magnetic Tripping Curves for GV2ME and GV2P
 Average Operating Times at 20 °C Related to Multiples of the Setting Current

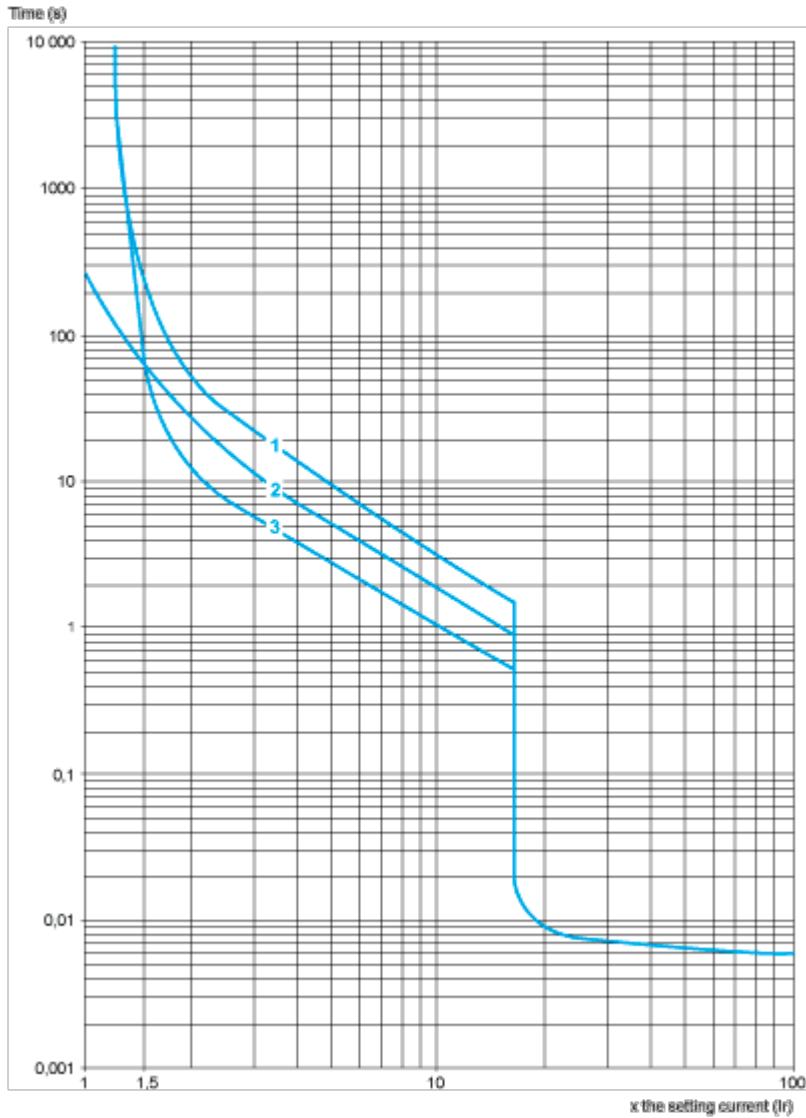

- 1 3 poles from cold state
- 2 2 poles from cold state
- 3 3 poles from hot state

Current Limitation on Short-Circuit for GV2ME and GV2P (3-Phase 400/415 V)

Dynamic Stress

$I_{peak} = f(\text{prospective } I_{sc}) \text{ at } 1.05 U_e = 435 \text{ V}$

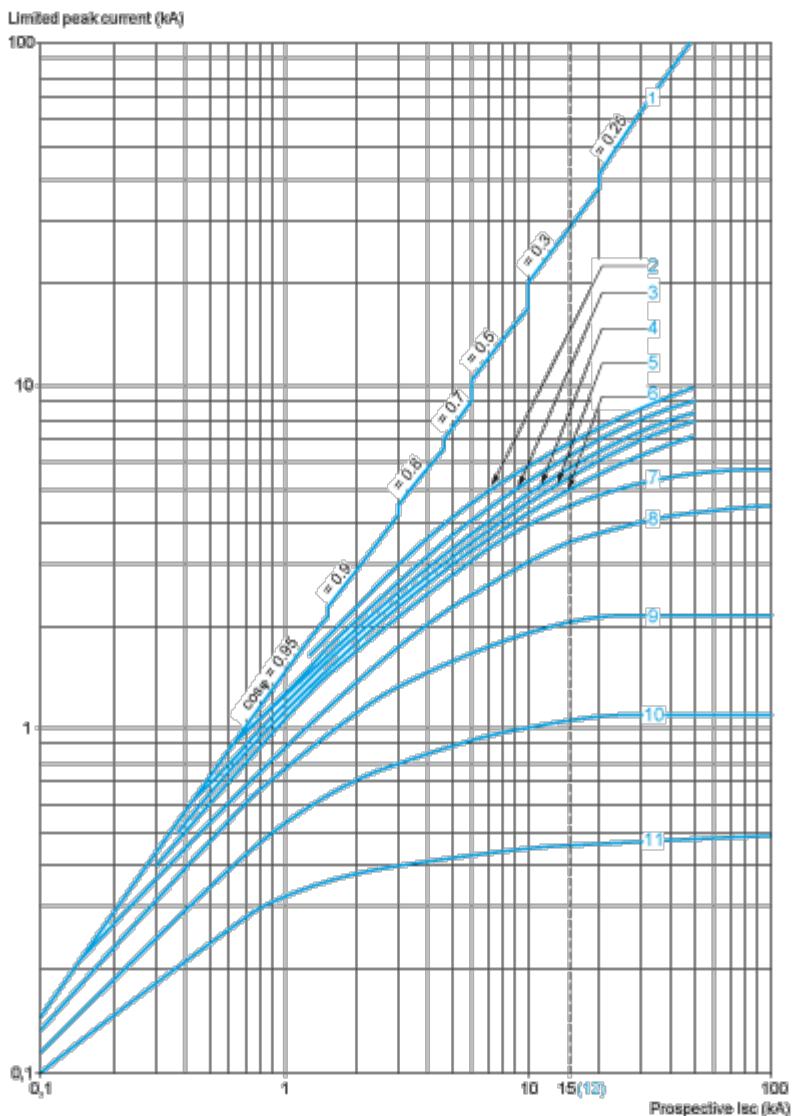

- 1 Maximum peak current
- 2 24-32 A
- 3 20-25 A
- 4 17-23 A
- 5 13-18 A
- 6 9-14 A
- 7 6-10 A
- 8 4-6.3 A
- 9 2.5-4 A
- 10 1.6-2.5 A
- 11 1-1.6 A
- 12 Limit of rated ultimate breaking capacity on short-circuit of GV2ME (14, 18, 23, and 25 A ratings).

Thermal Limit on Short-Circuit for GV2ME

Thermal Limit in kA^2s in the Magnetic Operating Zone

Sum of $I^2dt = f$ (prospective Isc) at 1.05 Ue = 435 V

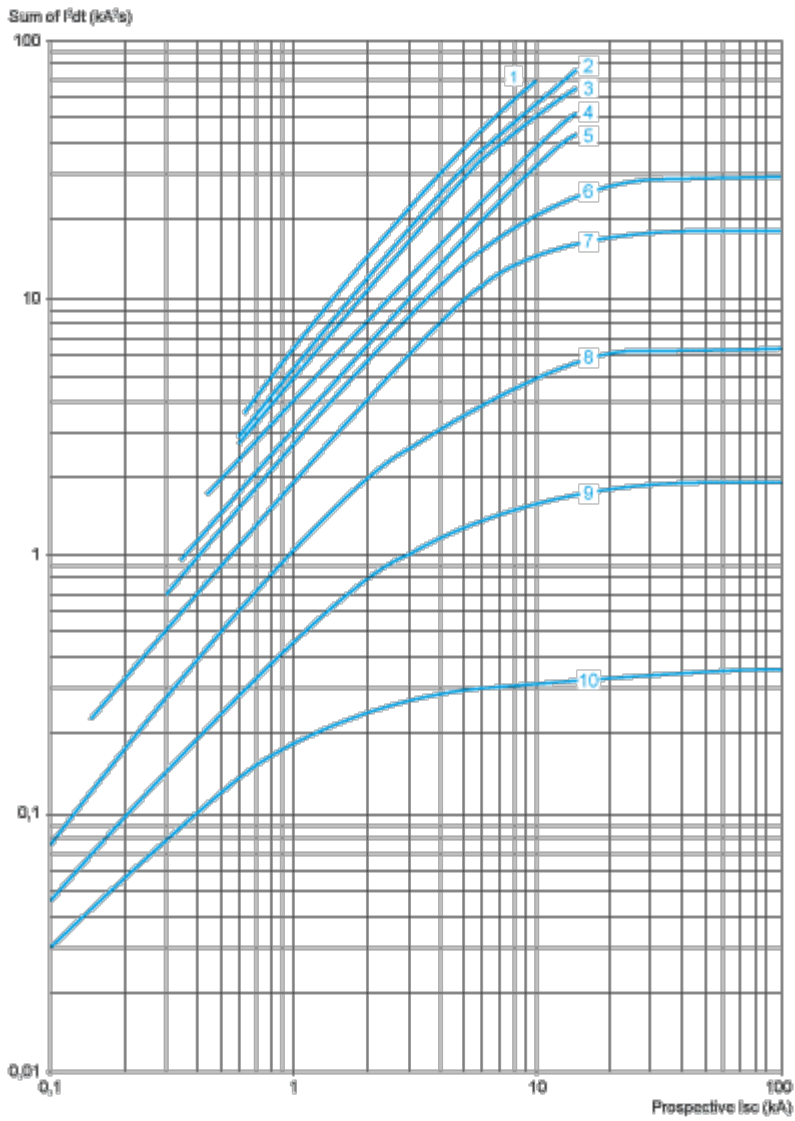

- 1 24-32 A
- 2 20-25 A
- 3 17-23 A
- 4 13-18 A
- 5 9-14 A
- 6 6-10 A
- 7 4-6.3 A
- 8 2.5-4 A
- 9 1.6-2.5 A
- 10 1-1.6 A

Dimensions Drawings

Dimension

GV2ME

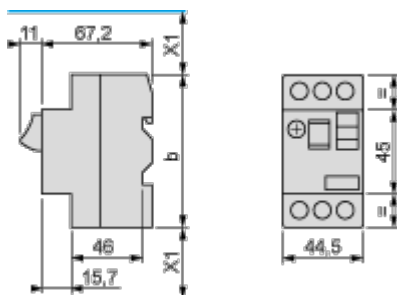

(1) Maximum

X1 Electrical clearance = 40 mm for $U_e \leq 690$ V

	b
GV2ME $\bullet\bullet$	89
GV2ME $\bullet\bullet$ 3	101

Mounting

GV2ME

On 35 mm rail

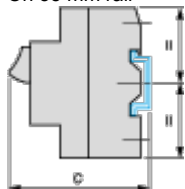

c = 78.5 on AM1 DP200 (35 x 7.5)

c = 86 on AM1 DE200, ED200 (35 x 15)

On panel with adapter plate GV2AF02

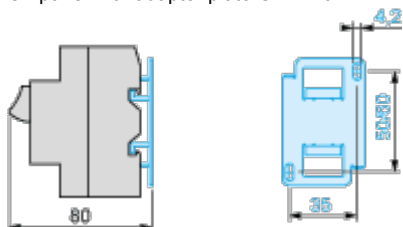

On pre-slotted plate AM1 PA

AF1 EA4

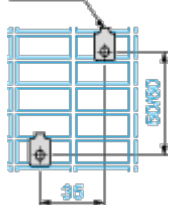

On rails DZ5 MB201

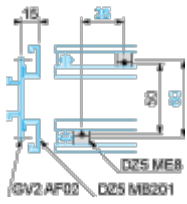

GV2AF01

Combination GV2ME + TeSys k contactor

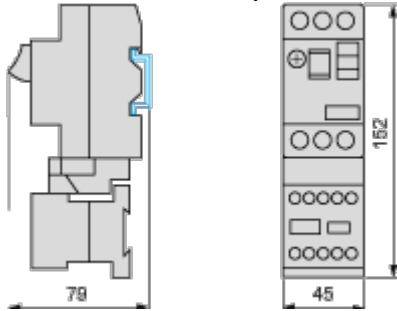

GV2AF3

Combination GV2ME + TeSys d contactor

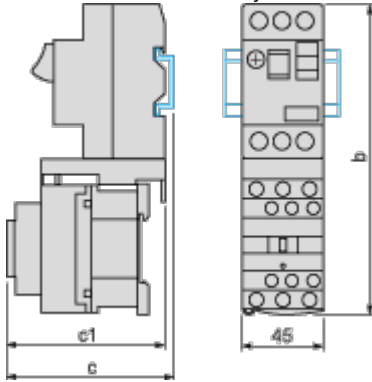

GV2ME +	LC1D09...D18	LC1D25 and D32
b	176.4	186.8
c1	94.1	100.4
c	99.6	105.9

GV2AF4 + LAD311

Combination GV2ME + TeSys d contactor

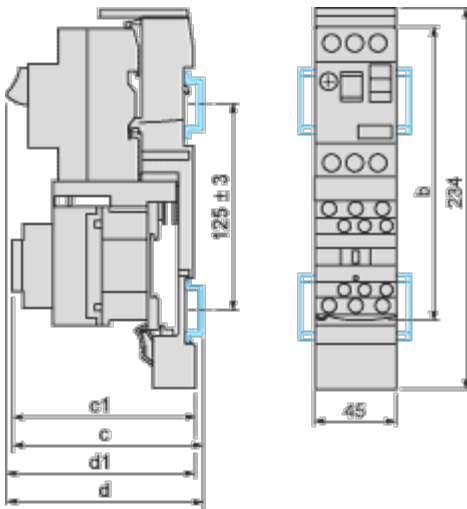

GV2ME +	LC1D09...D18	LC1D25 and D32
b	176.4	186.8
c1	103.1	136.4
c	135.6	141.9
d1	107	107
d	112.5	112.5

GV2ME + GV1L3 (Current Limiter)

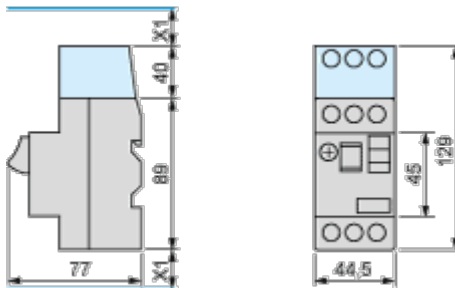

X1 = 10 mm for Ue = 230 V or 30 mm for 230 V < Ue ≤ 690 V

Connections and Schema

GV2ME•• and GV2RT

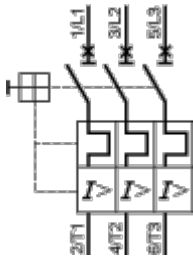

Connection of Undervoltage Trip for Dangerous Machines (Conforming to INRS) on GV2ME Only

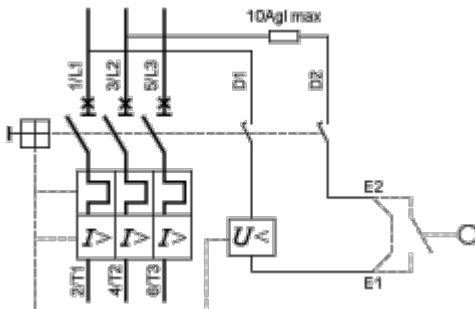

Offer Marketing Illustration

Product benefits / Features



TeSys Deca Motor Circuit Breakers
Range Accessories

Energy Sensor

Mounting and adapters

Terminal block

Combination block

Motor starter adapter plate

Current limiter

Comb busbar

Auxiliary contact blocks

The image displays a collection of accessories for TeSys Deca Motor Circuit Breakers. At the top left is a large black motor circuit breaker with a red handle. Below it, eight different accessories are shown in two rows of four. Each accessory is accompanied by a small label: Energy Sensor (a white rectangular device with a cable), Mounting and adapters (two grey metal brackets), Terminal block (a black plastic block with four terminals), Combination block (a black plastic block with four terminals and a red handle), Motor starter adapter plate (a black metal plate with four terminals), Current limiter (a black metal block with two terminals), Comb busbar (a long black metal bar with multiple terminals), and Auxiliary contact blocks (two black plastic blocks with multiple terminals).

Offer Marketing Illustration

Product benefits / Features



The image shows a TeSys Deca Motor Circuit Breaker, a black rectangular device with a red handle. It has three terminals on top labeled T1, T2, and T3, and three terminals on the bottom labeled 2U, 4U, and 6U. The handle is in the 'OFF' position. The device is set against a green circular background.

TeSys Deca Motor Circuit Breakers

Technical Benefits

- High breaking capacity up to 100 kA.
- Screw clamp for the connection, with lug and spring terminals.
- Easily identify the tripped breaker.
- Padlockable in all versions.
- Sealable thermal overload settings without additional accessories.
- Short circuit indication for better diagnostics when a trip occurs.
- Maximum 15 current ratings to cover from 0.1 A to 32 A motor current with a IP20 level for finger safety.

Offer Marketing Illustration

Product benefits / Features

TeSys Deca Motor Circuit Breakers



Universal Integration

Can be used for all type of applications across industry, infrastructure and buildings.



Complete protection

Provide short circuit protection, overload protection, motor (ON/OFF) control, all in a single product.



Standard Sync

Compliant to motor control and protection, in accordance with standards.



Offer Marketing Illustration

Product benefits / Features

TeSys Deca Motor Circuit Breakers

Technical Benefits



- High breaking capacity up to 100 kA.
- Screw clamp for the connection, with lug and spring terminals.
- Easily identify the tripped breaker.
- Padlockable in all versions.
- Sealable thermal overload settings without additional accessories.
- Short circuit indication for better diagnostics when a trip occurs.
- Maximum 15 current ratings to cover from 0.1 A to 32 A motor current with a IP20 level for finger safety.

Offer Marketing Illustration

Product benefits / Features



TeSys Deca Motor Circuit Breakers Range Accessories



Energy Sensor



Mounting and adapters



Terminal block

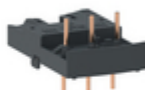

Combination block



Motor starter
adapter plate



Current limiter



Comb busbar



Auxiliary
contact blocks

Offer Marketing Illustration

Product benefits / Features

TeSys Deca Motor Circuit Breakers



Universal Integration

Can be used for all type of applications across industry, infrastructure and buildings.



Complete protection

Provide short circuit protection, overload protection, motor (ON/OFF) control, all in a single product.



Standard Sync

Compliant to motor control and protection, in accordance with standards.



Image of product / Alternate images

Alternative

