

Scheda dati

Specifiche



Int. autom. TeSys GV2 - magnetterm - pulsante - 13-18A - molla

GV2ME203

Prezzo: 122,95 EUR

Presentazione

Gamma	TeSys Deca
Nome Prodotto	TeSys GV2
Tipo Prodotto	Interruttore automatico
Nome Dispositivo	GV2ME
Applicazione	Protezione motore
Tecnologia sganciatore	Magnetotermico

Caratteristiche tecniche

Numero di poli	3P
Tipo di rete	CA
Categoria di utilizzazione	Categoria A conforme a IEC 60947-2 AC-3 conforme a IEC 60947-4-1 AC-3e conforme a IEC 60947-4-1
Frequenza di rete	50/60 Hz conforme a IEC 60947-2
Potenza motore in kW	7,5 kW a 400/415 V CA 50/60 Hz 9 kW a 500 V CA 50/60 Hz
Potere di interruzione	100 kA Icu conforme a IEC 60947-2 a 230/240 V CA 50/60 Hz 15 kA Icu conforme a IEC 60947-2 a 400/415 V CA 50/60 Hz 8 kA Icu conforme a IEC 60947-2 a 440 V CA 50/60 Hz 6 kA Icu conforme a IEC 60947-2 a 500 V CA 50/60 Hz 3 kA Icu conforme a IEC 60947-2 a 690 V CA 50/60 Hz
Potere di interruzione di servizio nominale [Ics]	100 % conforme a IEC 60947-2 a 230/240 V CA 50/60 Hz 50 % conforme a IEC 60947-2 a 400/415 V CA 50/60 Hz 50 % conforme a IEC 60947-2 a 440 V CA 50/60 Hz 75 % conforme a IEC 60947-2 a 500 V CA 50/60 Hz 75 % conforme a IEC 60947-2 a 690 V CA 50/60 Hz
Tipo di controllo	Pulsante
Corrente nominale [In]	18 A
campo di regolazione protezione termica	13...18 A conforme a IEC 60947-2
Corrente di sgancio magnetico	341 A
Corrente termica convenzionale in aria [Ith]	18 A conforme a IEC 60947-2
Tensione nominale di impiego [Ue]	690 V CA 50/60 Hz conforme a IEC 60947-2
Tensione nominale di isolamento [Ui]	690 V CA 50/60 Hz conforme a IEC 60947-2
Tensione nominale di tenuta agli impulsi [Uimp]	6 kV conforme a IEC 60947-2
Sensibilità mancanza di fase	Si conforme a IEC 60947-4-1
Attitudine all'isolamento	Si conforme a IEC 60947-1

Dissipazione energia per polo	2,5 W
Durata meccanica	100000 cicli
Durata elettrica	100000 cicli per AC-3 a 415 V In 100000 cicli per AC-3e a 415 V In
Servizio nominale	Ininterrotto conforme a IEC 60947-4-1
Connessioni - morsetti	Circuito di potenza: terminali a molla 2 cavi 1...6 mm ² solido Circuito di potenza: terminali a molla 2 cavi 1,5...4 mm ² flessibile senza terminazione cavo Circuito di potenza: terminali a molla 2 cavi 1...4 mm ² flessibile con terminazione cavo
Tipologia fissaggio	Guida DIN simmetrica 35 mm: agganciato Pannello: avvitato (con piastra di adattamento)
Posizione Di Montaggio	Orizzontale Verticale
larghezza	45 mm
Altezza	101 mm
Profondità	78,5 mm
peso prodotto	0,28 kg
Colore	Grigio scuro

Ambiente

norme di riferimento	EN/IEC 60947-2 EN/IEC 60947-4-1 UL 60947-4-1 CSA C22.2 No 60947-4-1 IEC/EN 60335-2-40:Annex JJ IEC/EN 60335-1:Clause 30.2
Certificazioni Prodotto	CCC UL CSA EAC ATEX LROS (Lloyds Register of shipping) BV RINA DNV-GL UKCA
Grado di protezione IK	IK04
Grado Di Protezione Ip	IP20 conforme a CEI 60529
tenuta climatica	conforme a IACS E10
Temperatura Di Stoccaggio	-40...80 °C
Resistenza Al Fuoco	960 °C conforme a IEC 60695-2-11
Temperatura Ambiente	-20...60 °C
Robustezza meccanica	Urti: 30 Gn per 11 ms Vibrazioni: 5 gn, 5...150 Hz
Altitudine di funzionamento	= 2000 m

Confezionamenti

Unità di misura confezione 1	PCE
Numero di unità per confezione 1	1
Confezione 1: altezza	5,600 cm
Confezione 1: larghezza	11,100 cm

Confezione 1: profondità	8,700 cm
Confezione 1: peso	322,000 g
Unità di misura confezione 2	S02
Numero di unità per confezione 2	20
Confezione 2: altezza	15,000 cm
Confezione 2: larghezza	30,000 cm
Confezione 2: profondità	40,000 cm
Confezione 2: peso	6,689 kg

Garanzia contrattuale

Garanzia	18 months
----------	-----------

L'obiettivo di Schneider Electric è raggiungere lo status di Net Zero entro il 2050 attraverso partnership nella supply chain, materiali a basso impatto e circolarità, grazie alla nostra campagna "Use Better, Use Longer, Use Again" (Usa meglio, usa più a lungo, utilizza di nuovo), per prolungare la durata dei prodotti e la riciclabilità.

[Spiegazione dei Environmental Data >](#)

[Come valutiamo la sostenibilità dei prodotti >](#)

Impronta ambientale

Impronta di carbonio (kg CO2 eq.) **43**

Informazioni ambientali disponibili [Profilo ambientale del prodotto](#)

Use Better

Materiali e imballaggio

Confezione di cartone riciclato **Si**

Imballaggio senza plastica **Si**

[Direttiva RoHS Unione europea](#) **Conforme alle esenzioni**

Numero SCIP **04104e70-ba29-493c-b2cc-b5837d1f879b**

Regolamento REACH [Dichiarazione REACH](#)

Use Again

Reimballaggio e rifabbricazione

Profilo di circolarità [Informazioni sulla fine della vita](#)

Ritiro del prodotto **No**

WEEE  **Per i paesi dell'Unione Europea è necessario smaltire il prodotto seguendo le indicazioni specifiche della raccolta differenziata e non deve MAI finire nei bidoni della spazzatura generica.**

Performance Curves

Thermal-Magnetic Tripping Curves for GV2ME and GV2P
 Average Operating Times at 20 °C Related to Multiples of the Setting Current

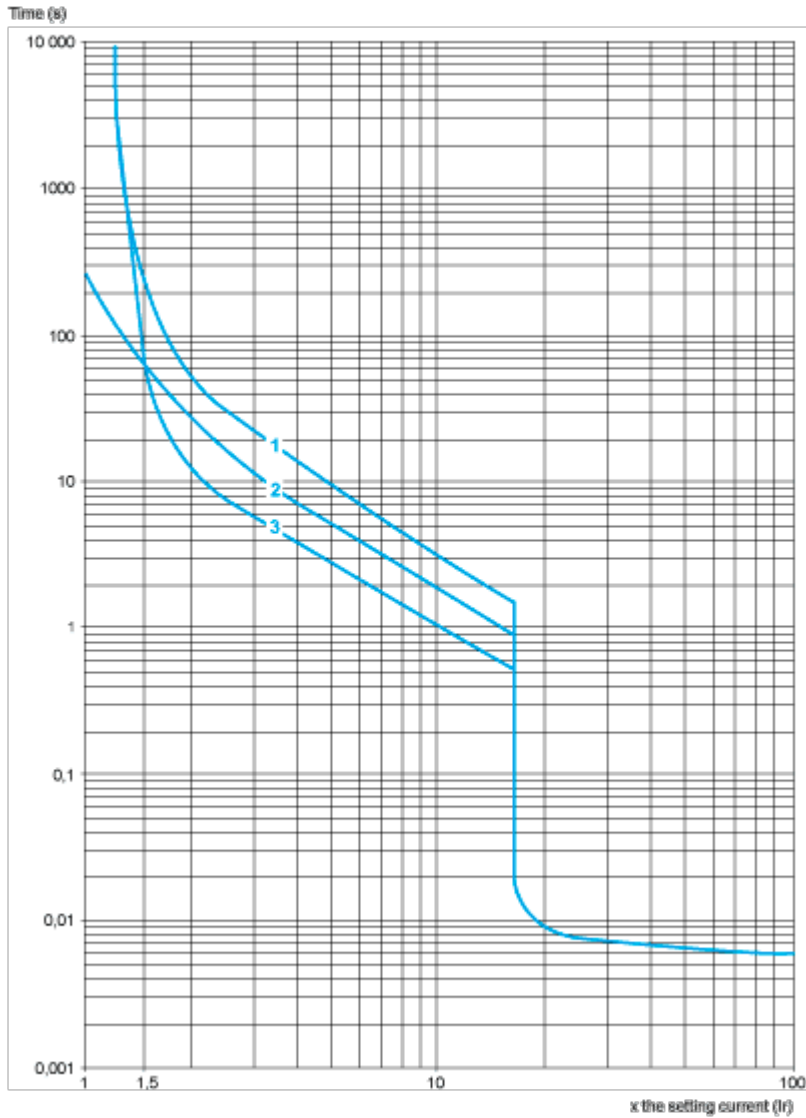

- 1 3 poles from cold state
- 2 2 poles from cold state
- 3 3 poles from hot state

Current Limitation on Short-Circuit for GV2ME and GV2P (3-Phase 400/415 V)

Dynamic Stress

$I_{peak} = f(\text{prospective } I_{sc}) \text{ at } 1.05 U_e = 435 \text{ V}$

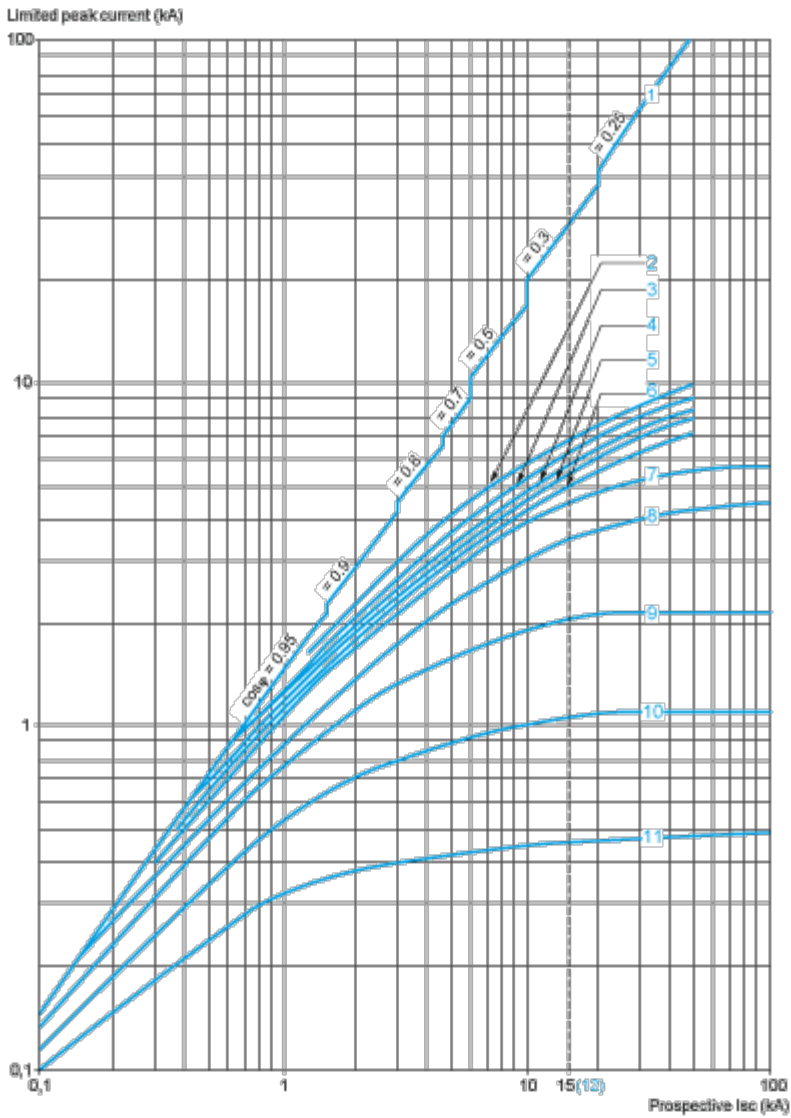

- 1 Maximum peak current
- 2 24-32 A
- 3 20-25 A
- 4 17-23 A
- 5 13-18 A
- 6 9-14 A
- 7 6-10 A
- 8 4-6.3 A
- 9 2.5-4 A
- 10 1.6-2.5 A
- 11 1-1.6 A
- 12 Limit of rated ultimate breaking capacity on short-circuit of GV2ME (14, 18, 23, and 25 A ratings).

Thermal Limit on Short-Circuit for GV2ME

Thermal Limit in kA^2s in the Magnetic Operating Zone

Sum of $I^2dt = f$ (prospective Isc) at 1.05 Ue = 435 V

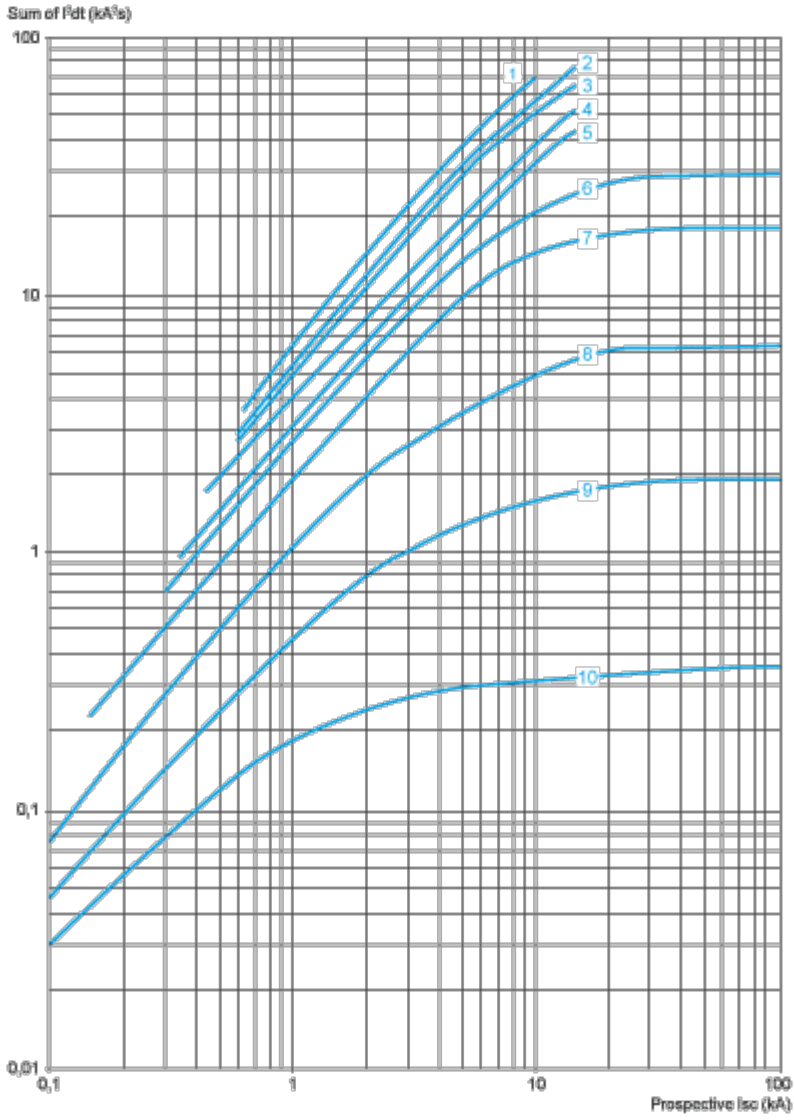

- 1 24-32 A
- 2 20-25 A
- 3 17-23 A
- 4 13-18 A
- 5 9-14 A
- 6 6-10 A
- 7 4-6.3 A
- 8 2.5-4 A
- 9 1.6-2.5 A
- 10 1-1.6 A

Dimensions Drawings

Dimension

GV2ME

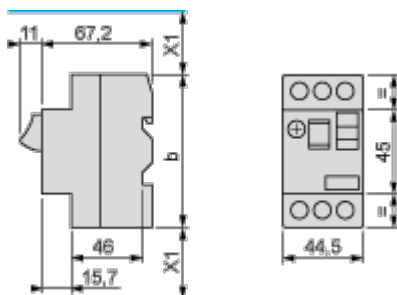

(1) Maximum

X1 Electrical clearance = 40 mm for $U_e \leq 690$ V

	b
GV2ME $\bullet\bullet$	89
GV2ME $\bullet\bullet$ 3	101

Mounting

GV2ME

On 35 mm rail

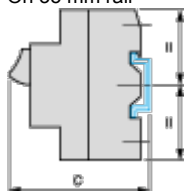

c = 78.5 on AM1 DP200 (35 x 7.5)

c = 86 on AM1 DE200, ED200 (35 x 15)

On panel with adapter plate GV2AF02

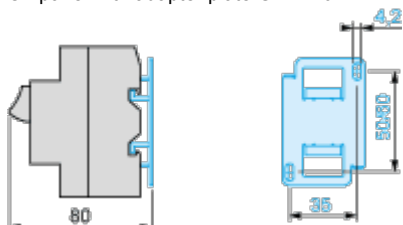

On pre-slotted plate AM1 PA

AF1 EA4

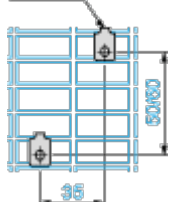

On rails DZ5 MB201

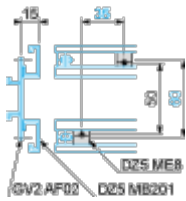

GV2AF01

Combination GV2ME + TeSys k contactor

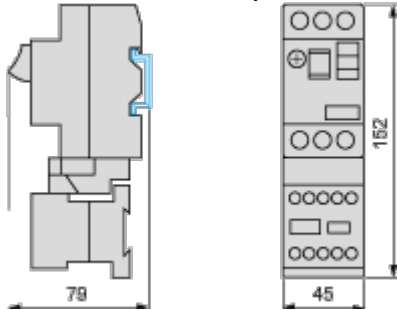

GV2AF3

Combination GV2ME + TeSys d contactor

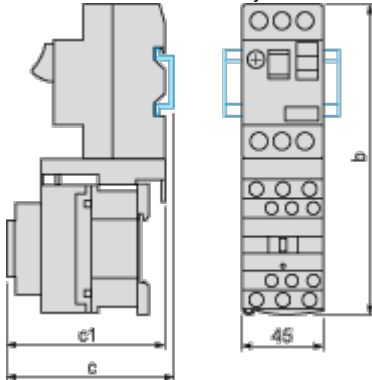

GV2ME +	LC1D09...D18	LC1D25 and D32
b	176.4	186.8
c1	94.1	100.4
c	99.6	105.9

GV2AF4 + LAD311

Combination GV2ME + TeSys d contactor



GV2ME +	LC1D09...D18	LC1D25 and D32
b	176.4	186.8
c1	103.1	136.4
c	135.6	141.9
d1	107	107
d	112.5	112.5

GV2ME + GV1L3 (Current Limiter)

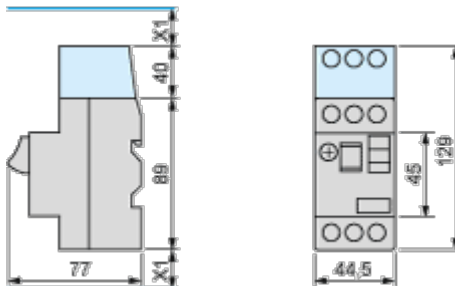

X1 = 10 mm for Ue = 230 V or 30 mm for 230 V < Ue ≤ 690 V

Connections and Schema

GV2ME•• and GV2RT

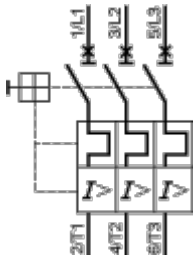

Connection of Undervoltage Trip for Dangerous Machines (Conforming to INRS) on GV2ME Only

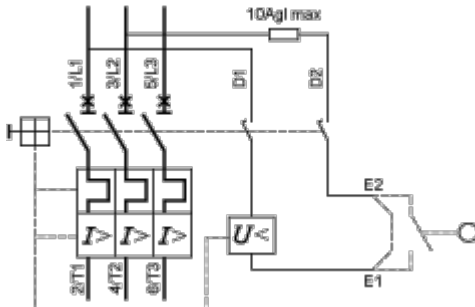

Offer Marketing Illustration

Product benefits / Features



TeSys Deca Motor Circuit Breakers
Range Accessories

Energy Sensor

Mounting and adapters

Terminal block

Combination block

Motor starter adapter plate

Current limiter

Comb busbar

Auxiliary contact blocks

The image displays a collection of accessories for TeSys Deca Motor Circuit Breakers. At the top left is a large black motor circuit breaker with a red handle. Below it, two rows of smaller components are shown, each with a label. The first row includes an Energy Sensor (a white rectangular device with wires), Mounting and adapters (two grey metal plates), Terminal block (a black block with four terminals), and Combination block (a black block with four terminals and a red handle). The second row includes a Motor starter adapter plate (a black plate with four terminals), Current limiter (a black rectangular device with two terminals), Comb busbar (a long black bar with multiple terminals), and Auxiliary contact blocks (two black blocks with multiple terminals).

Offer Marketing Illustration

Product benefits / Features

TeSys Deca Motor Circuit Breakers



Universal Integration

Can be used for all type of applications across industry, infrastructure and buildings.



Complete protection

Provide short circuit protection, overload protection, motor (ON/OFF) control, all in a single product.



Standard Sync

Compliant to motor control and protection, in accordance with standards.



Offer Marketing Illustration

Product benefits / Features



The image shows a TeSys Deca Motor Circuit Breaker, a black rectangular device with a red handle. It has three screw terminals on top labeled T1, T2, and T3, and three on the bottom labeled 2U, 4U, and 6U. The front panel features a red handle with 'OFF' and 'ON' markings, a green indicator light, and a QR code. The Schneider logo is visible at the bottom of the device.

TeSys Deca Motor Circuit Breakers

Technical Benefits

- High breaking capacity up to 100 kA.
- Screw clamp for the connection, with lug and spring terminals.
- Easily identify the tripped breaker.
- Padlockable in all versions.
- Sealable thermal overload settings without additional accessories.
- Short circuit indication for better diagnostics when a trip occurs.
- Maximum 15 current ratings to cover from 0.1 A to 32 A motor current with a IP20 level for finger safety.

Image of product / Alternate images

Alternative



