

# PacT Series

## TransferPacT Active Automatic

## TransferPacT Automatic

## TransferPacT Remote

Transfer Switching Equipment  
32–1600 A

## User Guide

PacT series offers world class breakers and switches.

DOCA0214EN-06  
09/2025



# Legal Information

The information provided in this document contains general descriptions, technical characteristics and/or recommendations related to products/solutions.

This document is not intended as a substitute for a detailed study or operational and site-specific development or schematic plan. It is not to be used for determining suitability or reliability of the products/solutions for specific user applications. It is the duty of any such user to perform or have any professional expert of its choice (integrator, specifier or the like) perform the appropriate and comprehensive risk analysis, evaluation and testing of the products/solutions with respect to the relevant specific application or use thereof.

The Schneider Electric brand and any trademarks of Schneider Electric SE and its subsidiaries referred to in this document are the property of Schneider Electric SE or its subsidiaries. All other brands may be trademarks of their respective owner.

This document and its content are protected under applicable copyright laws and provided for informative use only. No part of this document may be reproduced or transmitted in any form or by any means (electronic, mechanical, photocopying, recording, or otherwise), for any purpose, without the prior written permission of Schneider Electric.

Schneider Electric does not grant any right or license for commercial use of the document or its content, except for a non-exclusive and personal license to consult it on an "as is" basis.

Schneider Electric reserves the right to make changes or updates with respect to or in the content of this document or the format thereof, at any time without notice.

**To the extent permitted by applicable law, no responsibility or liability is assumed by Schneider Electric and its subsidiaries for any errors or omissions in the informational content of this document, as well as any non-intended use or misuse of the content thereof.**

# Table of Contents

Safety Information .....	7
About the Document .....	8
Introduction to TransferPacT Transfer Switching Equipment .....	11
PacT Series Master Range .....	12
Overview .....	13
Hardware Description .....	14
Accessories .....	22
Technical Characteristics .....	24
Weights .....	25
TransferPacT Switch Functions and Characteristics .....	26
TransferPacT Controller Functions and Characteristics .....	28
Assembly Matrix .....	31
TransferPacT Controller .....	32
TransferPacT Transfer Switching Equipment Overview .....	33
Controller Function Module .....	34
Function Module Package Details .....	36
Voluntary Remote Control .....	37
Genset Start and Alarm .....	39
Source Indication .....	41
Load Shedding and Availability Warning .....	43
Transfer Inhibit and Remote Testing .....	45
BUS Extension and 24 VDC Auxiliary Supply .....	47
Fire Protections 24 V DC Pulse Input .....	49
Fire Protection 24 V DC Constant Input .....	50
Fire Protection 230 V AC Constant Input .....	51
Fire Protection Dry Contact Input .....	52
Modbus RTU (Serial Port) .....	53
Limitation of Accessories .....	54
Input and Output Terminal Functions for TransferPacT Remote .....	55
Overview .....	55
Product Availability .....	56
Remote Transfer .....	57
Wiring .....	58
Wiring Precautions .....	59
Wiring of Function Modules .....	60
TPCDIO19 : Source Indication .....	65
Wiring of Auxiliary Contacts .....	66
Wiring Diagrams for Frame 100: 32–100 A .....	69
Wiring Diagrams for Frame 160: 80–160 A .....	71
Wiring Diagrams for Frame 250: 100–250 A, Frame 630: 320–630 A and Frame 800: 800 A .....	72
Wiring Diagrams for Frame 1600: 800–1600 A .....	73
Mechanism Accessories .....	74
Overview .....	75
Power Connection Accessories .....	76
Steel Connector .....	76
Aluminum Connector .....	77
Linergy DP Distribution Block .....	78

Terminal Extension .....	79
Spreader .....	80
Load Extension Bar .....	81
Compression Lug .....	82
Vertical Connection Adapter .....	84
Cable-lug Adapter .....	85
Insulation Accessories.....	86
Terminal Cover.....	86
Interphase Barrier .....	87
Terminal Shield .....	88
Insulating Screen .....	89
PowerTag .....	90
Auxiliary Contact.....	91
Upside-down Installation Kit.....	92
Insulation Rules .....	93
HMI .....	97
Overview.....	98
Automatic HMI with Rotary Switch.....	99
Active Automatic HMI with LCD Display .....	101
Wizard Setup .....	102
Home Page of LCD Display.....	104
Quickview Page .....	105
Measurement Page .....	106
Status Page.....	107
Set & Operate Page .....	109
Quick Menu Tour .....	136
External HMI .....	138
Operations on ATSE .....	139
Overview.....	140
Automatic HMI with Rotary Switch as Embedded HMI.....	141
Preferable Source Selection.....	141
Transfer Condition.....	142
Time Delay .....	146
Active Automatic HMI with LCD Display as Embedded HMI.....	149
Preferable Source Selection.....	149
Status Description Based on Source Selection .....	150
Transfer Condition.....	152
Time Delay .....	157
Control Mode.....	160
Overview .....	160
Auto Mode .....	162
Communication Control .....	173
Voluntary Transfer Mode.....	178
Test Mode.....	181
Return or Start from Auto Mode at Off Position .....	186
Local Control Mode .....	187
Transfer Inhibit Mode.....	189
Fire Protection Mode .....	189
Force to Off Mode .....	189
Handle Transfer Mode .....	189
Operations on RTSE.....	190

---

Overview.....	191
Remote Transfer Process.....	191
Remote Transfer Condition.....	191
Modbus Communication.....	192
Introduction.....	193
Modbus Client-Server Principle.....	193
Modbus Functions.....	197
Modbus Exception Codes.....	200
Modbus Registers.....	201
Alarms and Troubleshooting.....	212
Overview.....	213
Alarm.....	214
Warning.....	217
Event Logs.....	224
Dielectric Test.....	228
Cybersecurity.....	229
Acronyms and Terminology.....	230



# Safety Information

## Important Information

### NOTICE

Read these instructions carefully, and look at the equipment to become familiar with the device before trying to install, operate, service, or maintain it. The following special messages may appear throughout this documentation or on the equipment to warn of potential hazards or to call attention to information that clarifies or simplifies a procedure.





The addition of this symbol to a “Danger” or “Warning” safety label indicates that an electrical hazard exists which will result in personal injury if the instructions are not followed.



This is the safety alert symbol. It is used to alert you to potential personal injury hazards. Obey all safety messages that follow this symbol to avoid possible injury or death.

 <b>DANGER</b>
<b>DANGER</b> indicates a hazardous situation which, if not avoided, <b>will result in</b> death or serious injury.

 <b>WARNING</b>
<b>WARNING</b> indicates a hazardous situation which, if not avoided, <b>could result in</b> death or serious injury.

 <b>CAUTION</b>
<b>CAUTION</b> indicates a hazardous situation which, if not avoided, <b>could result in</b> minor or moderate injury.

<b>NOTICE</b>
<b>NOTICE</b> is used to address practices not related to physical injury.

### PLEASE NOTE

Electrical equipment should be installed, operated, serviced and maintained only by qualified personnel. No responsibility is assumed by Schneider Electric for any consequences arising out of the use of this material.

A qualified person is one who has skills and knowledge related to the construction, installation, and operation of electrical equipment and has received safety training to recognize and avoid the hazards involved.

# About the Document

## Document Scope

Use this guide to:

- Familiarize yourself with the mechanical and electrical characteristics of the components of TransferPac™ range of Automatic Transfer Switching Equipment (ATSE) and Remote Transfer Switching Equipment (RTSE).
- Assemble and wire the ATSE and RTSE.

## Validity Note

This user guide is valid for TransferPacT range of ATSE and RTSE configurations as mentioned below:

- Six current rating ranges:
  - Frame 100: rated current 32-100 A
  - Frame 160: rated current 80-160 A
  - Frame 250: rated current 100-250 A
  - Frame 630: rated current 320-630 A
  - Frame 800: rated current 800 A
  - Frame 1600: rated current 800-1600 A
- Number of poles
  - 2P (available for frame 100 only)
  - 3P
  - 4P

The availability of some functions described in this guide depends on physical modules installed on the TransferPacT range of ATSE and RTSE.

## General Cybersecurity Information

In recent years, the growing number of networked machines and production plants has seen a corresponding increase in the potential for cyber threats, such as unauthorized access, data breaches, and operational disruptions. You must, therefore, consider all possible cybersecurity measures to help protect assets and systems against such threats.

To help keep your Schneider Electric products secure and protected, it is in your best interest to implement the cybersecurity best practices as described in the [Cybersecurity Best Practices](#) document.

Schneider Electric provides additional information and assistance:

- [Subscribe to the Schneider Electric security newsletter.](#)
- [Visit the Cybersecurity Support Portal web page to:](#)
  - [Find Security Notifications.](#)
  - [Report vulnerabilities and incidents.](#)
- [Visit the Schneider Electric Cybersecurity and Data Protection Posture web page to:](#)
  - [Access the cybersecurity posture.](#)
  - [Learn more about cybersecurity in the cybersecurity academy.](#)
  - [Explore the cybersecurity services from Schneider Electric.](#)

## Environmental Data

For product compliance and environmental information, refer to the Schneider Electric Environmental Data Program.

## Online Information

The information contained in this document is likely to be updated at any time. Schneider Electric strongly recommends that you have the most recent and up-to-date version available on [www.se.com/ww/en/download](http://www.se.com/ww/en/download).

The technical characteristics of the devices described in the present document also appear online. To access the information online, go to the Schneider Electric home page [www.se.com](http://www.se.com).

The technical characteristics presented in this guide should be the same as those that appear online. If you see a difference between the information contained in this guide and online information, use the online information.

## Available Languages of the Document

- English (DOCA0214EN)
- French (DOCA0214FR)
- Chinese (DOCA0214ZH)
- Spanish (DOCA0214ES)

## Related Documentation

Document title	Document reference number
TransferPacT Active Automatic and TransferPacT Automatic Transfer Switching Equipment Cybersecurity Guide	DOCA0215EN DOCA0215FR DOCA0215IT DOCA0215DE DOCA0215ZH DOCA0215ES DOCA0215PT DOCA0215RU
TransferPacT Active Automatic 32-100 A / TransferPacT Automatic 32-100 A Transfer Switching Equipment Instruction Sheet	JYT3049801
TransferPacT Active Automatic 80-160 A and TransferPacT Automatic 80-160 A Transfer Switching Equipment Instruction Sheet	JYT3049901
TransferPacT Active Automatic 100-250 A / TransferPacT Automatic 200-250 A / TransferPacT Remote 160-250 A Transfer Switching Equipment Instruction Sheet	GEX2525501
TransferPacT Active Automatic 320-630 A / TransferPacT Automatic 320-630 A / TransferPacT Remote 320-630 A Transfer Switching Equipment Instruction Sheet	GEX2525601

Document title	Document reference number
TransferPacT Active Automatic 800 A / TransferPacT Automatic 800 A / TransferPacT Remote 800 A Transfer Switching Equipment Instruction Sheet	BQT1751501
TransferPacT Active Automatic 800-1600 A Transfer Switching Equipment Instruction Sheet	BQT7680301

## Information on Non-Inclusive or Insensitive Terminology

As a responsible, inclusive company, Schneider Electric is constantly updating its communications and products that contain non-inclusive or insensitive terminology. However, despite these efforts, our content may still contain terms that are deemed inappropriate by some customers.

## Trademarks

*QR Code* is a registered trademark of DENSO WAVE INCORPORATED in Japan and other countries.

# Introduction to TransferPacT Transfer Switching Equipment

## What's in This Chapter

PacT Series Master Range .....	12
Overview .....	13
Hardware Description .....	14
Accessories .....	22

## PacT Series Master Range

Future-proof your installation with Schneider Electric's low-voltage and medium-voltage Pact Series. Built on legendary Schneider Electric innovation, the Pact Series comprises world-class circuit breakers, switches, residual current devices and fuses, for all standard and specific applications. Experience robust performance with Pact Series within the EcoStruxure-ready switchgear, from 16 to 6300 A in low-voltage and up to 40.5 kV in medium-voltage.

# Overview

TransferPacT is a high speed, compact, modular design intelligent automatic transfer switch that provide maximum scalability and robust performance.

- TransferPacT Automatic provides quick setting and easy view interface.
- TransferPacT Active Automatic provides comprehensive functions with a build-in controller and display. It is also provided with optional extended HMI to display the HMI on the panel.
- TransferPacT Remote provides support to third party control system and provides quick setting and easy operation.

The TransferPacT ATSE/RTSE is an equipment containing a switching device for disconnecting the load circuits from one supply and connecting to another.

It is a PC class ATSE/RTSE designed switch conforming to IEC 60947-6-1 standard and available from 32 to 1600 A in 2, 3, and 4 poles with rated operating voltage from 208-240 V (phase to phase, for frame 250/630/800 only), 380-440 V (phase to phase) and 220-250 V (phase to neutral, for frame 100 only).

There are three types of switching equipment:

- Automatic Transfer Switching Equipment (ATSE): Self-acting transfer switching equipment, including all necessary sensing inputs, monitoring, and control logic for transferring operations.
- Remote Transfer Switching Equipment (RTSE): Transfer switching equipment that is electrically operated and not self-acting.
- Manual Transfer Switching Equipment (MTSE): Transfer switching equipment operated manually and non-electrically.

# Coding Principle

The commercial reference of Automatic Transfer Switching Equipment (ATSE) and Remote Transfer Switching Equipment (RTSE) are coded with significant features to explain the type of frame ratings, transition type, controller type, rated voltage, rated current, and number of poles.

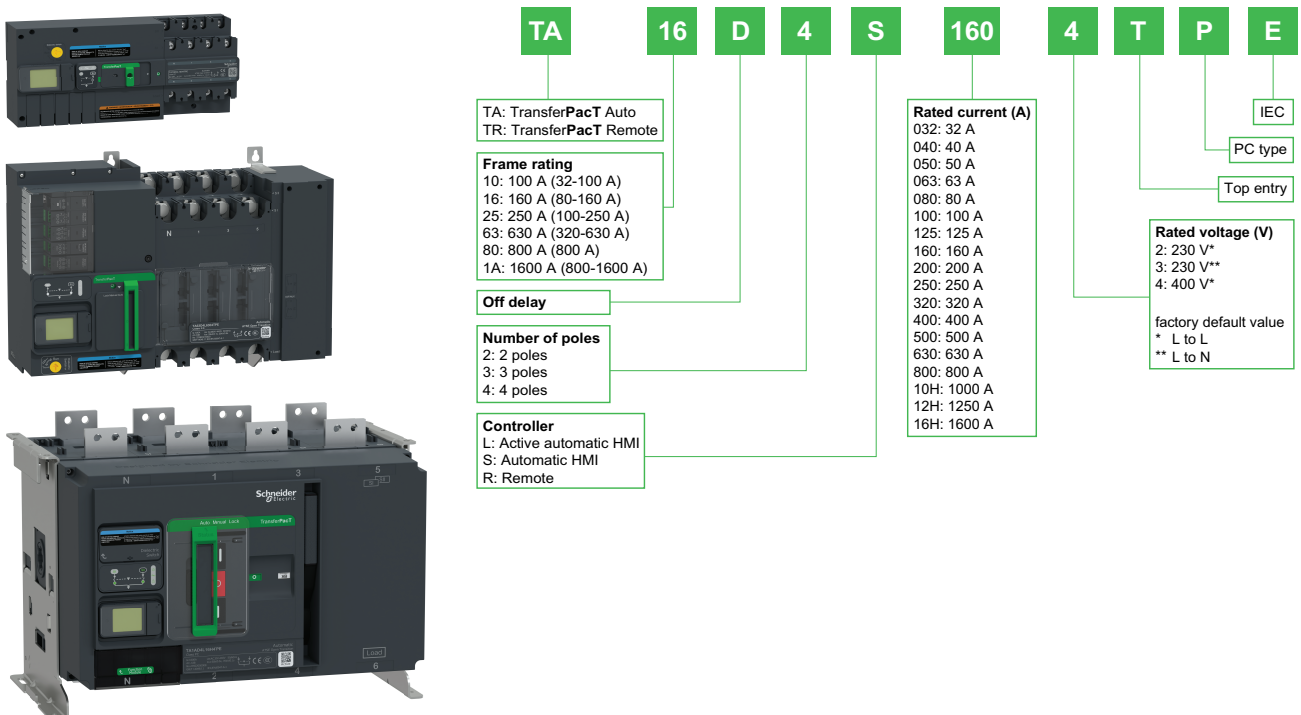

# Hardware Description

## Equipment Description

**TransferPacT Active Automatic / Automatic 32-100, 80-160 A**

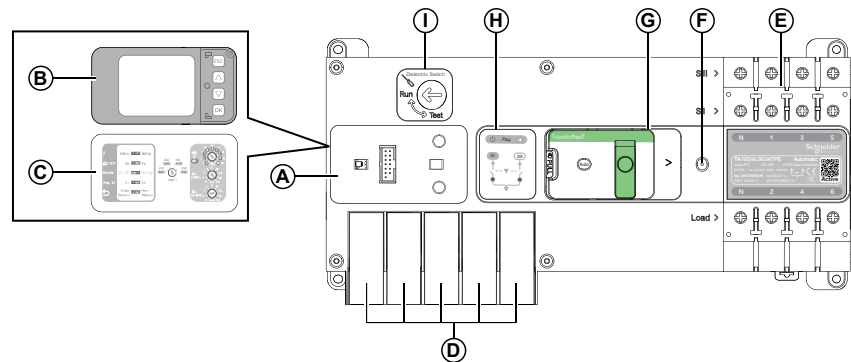

**TransferPacT Active Automatic / Automatic / Remote 100–250, 320–630, 800 A**

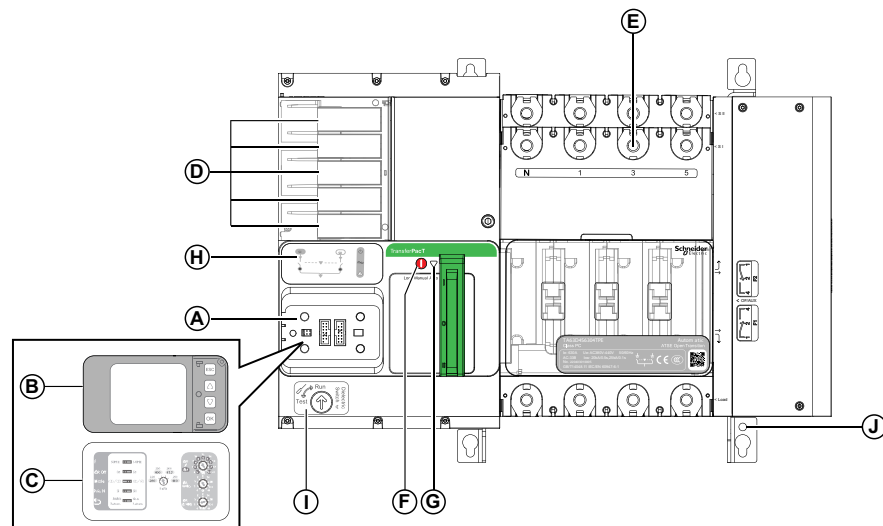

**TransferPacT Active Automatic 800-1600 A**

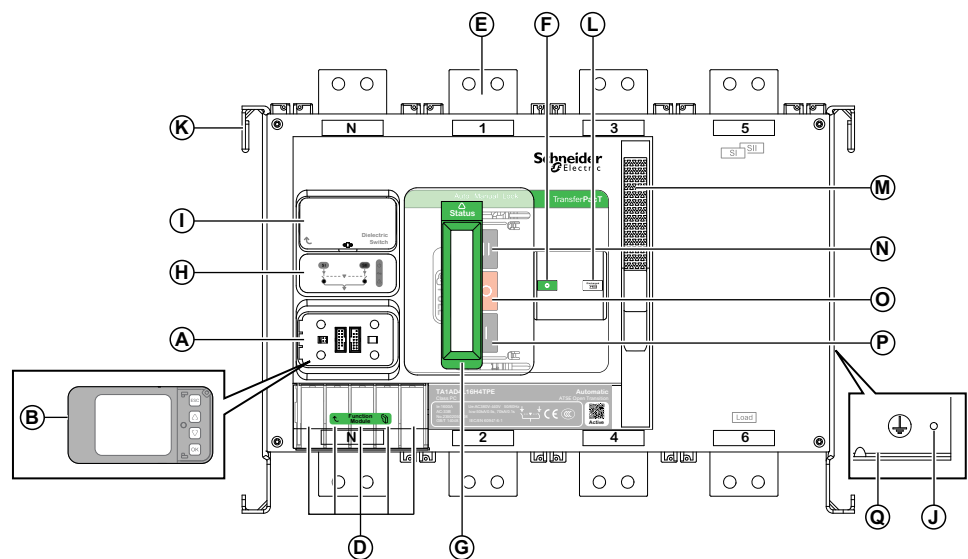

<b>Label</b>	<b>Description</b>
A	Position for HMI modular
B	Active Automatic HMI (with LCD display)
C	Automatic HMI (with rotary switch)
D	Slots for function module
E	Power connections
F	Position indicator
G	3- position slider: Auto/Manual/Lock
H	Single line diagram
I	Dielectric switch
J	Protective earth
K	Carrying grip
L	Spring charged and ready-to-open indicator
M	Spring charged handle
N	Source II push button
O	OFF position push button
P	Source I push button
Q	Mounting side plate

## Active Automatic HMI Description

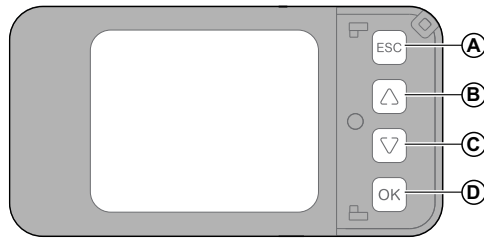

Label	Description
A	Navigation button to return to previous page
B	Navigation button for rolling up
C	Navigation button for rolling down
D	OK button to confirm any status

## Automatic HMI Description

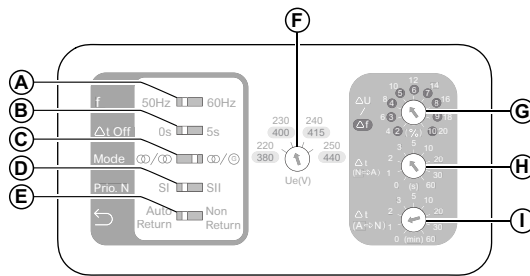

Label	Description
A	Rated frequency
B	Time delay for center-off position
C	Type of sources: <ul style="list-style-type: none"> <li>• Utility/Utility</li> <li>• Utility/Genset</li> </ul>
D	Source priority
E	Transition mode for return to normal position
F	Rated voltage
G	Voltage and frequency thresholds setting
H	Transfer time delay in seconds from normal source to alternate source
I	Transfer time delay in minutes from alternate source to normal source

## Single Line Diagram Description

### TransferPacT Active Automatic / Automatic 32-100, 80-160 A

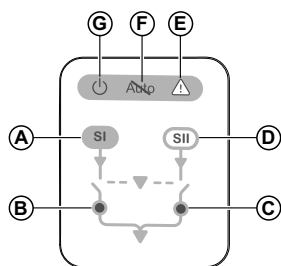

### TransferPacT Active Automatic / Automatic 100–250, 320–630, 800 A TransferPacT Active Automatic 800–1600 A

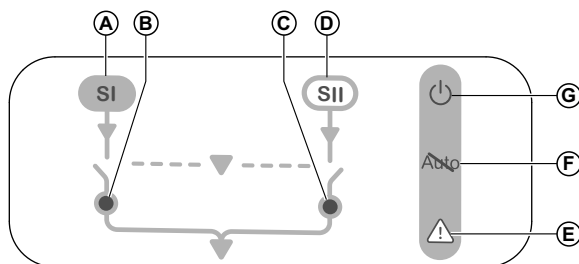

### TransferPacT Remote 160-250, 320-630, 800 A



Label	Description
A	Source I power status indicator
B	Contact position of source I
C	Contact position of source II
D	Source II power status indicator
E	Alarm indicator
F	Not in Auto status indicator
G	Power ON indicator
H	Run status indicator

# Single Line Diagram LED

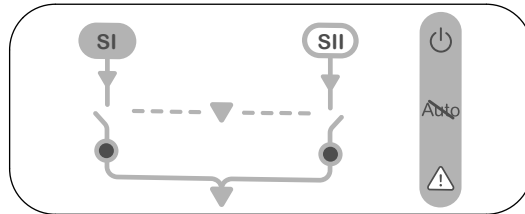
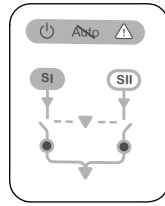

LED indication	Status	Description
	-----	No energy, ATSE power off
		ATSE updating in process or in Test mode
		ATSE is running in normal operation, ready to transfer
	-----	The ATSE is running in Auto mode
		The ATSE will be in Not in Automatic mode, and will not automatically transfer in case of source failure.
	-----	No alarm
		Alarm is active
	-----	No Source I
		Source I out of range
		Source I present and in the range
	-----	No Source II
		Source II out of range
		Source II present and in the range
	-----	Source I is opened (Not connected)
		Time delay is running for transferring
		Source I is closed (Connected)
	-----	Source II is opened (Not connected)
		Time delay is running for transferring
		Source II is closed (Connected)







LED indication	Status	Description
⏻	-----	Both sources are out of range, or the transfer switch equipment is in manual/lock mode
	—■■■■■	Either source is in range and transfer switch equipment is in RUN mode
⚠	-----	No alarm
	—■■■■■	Alarm is active (transfer failure, transfer switch equipment contact position failure, internal error occurred)

**NOTE:** The LED indicator on the equipment and the external HMI is for reference. In the event of a contradiction between the LED and the position indicator on the ATSE, the latter prevails.

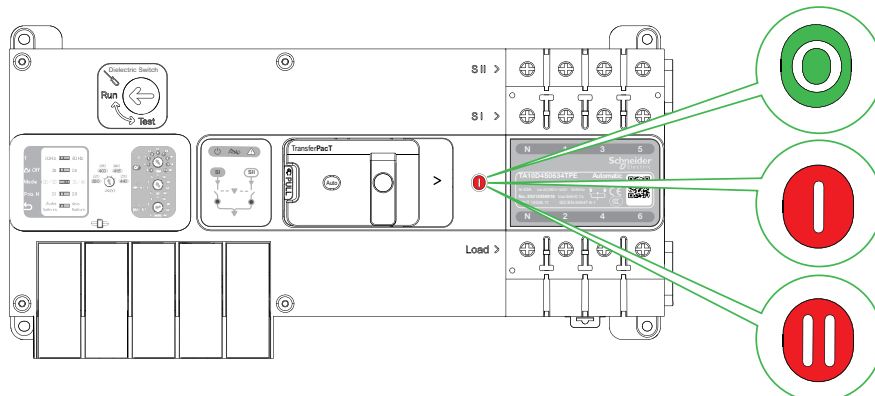
## Position Indicator







**TransferPacT Active Automatic / Automatic 32-100, 80-160, 100-250, 320-630, 800 A**  
**TransferPacT Remote 160-250, 320-630, 800 A**

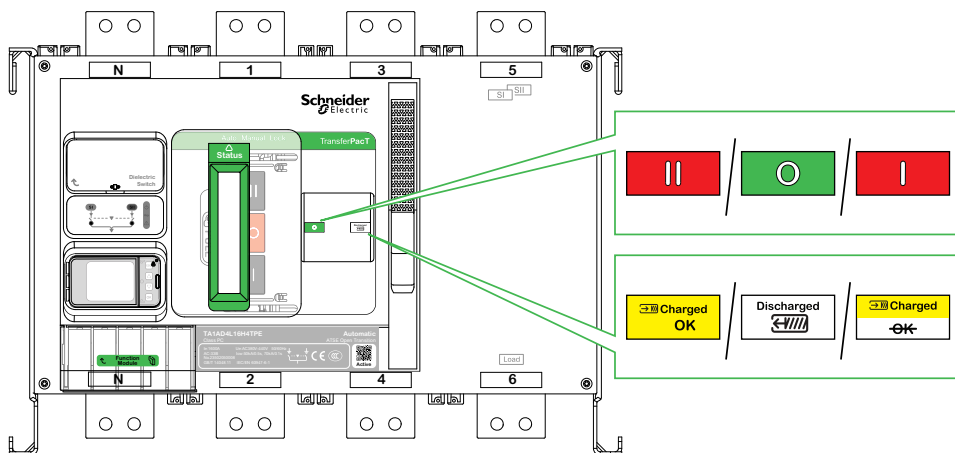



Position indicator	Status
	OFF
	Source I is connected
	Source II is connected

**TransferPacT Active Automatic 800-1600 A**



Position indicator	Status
 	Device is OFF, and mechanism spring is charged.
 	Device is OFF, and mechanism spring is discharged.
 	Source I is connected, and mechanism spring is charged.

Position indicator	Status
	<p>Source I is connected, and mechanism spring is discharged.</p>
	<p>Source II is connected, and mechanism spring is charged.</p>
	<p>Source II is connected, and mechanism spring is discharged.</p>

## Accessories

### External HMI Accessories

Accessories for the external HMI are as below:

- External HMI for Active Automatic HMI (TPCCIF04)
- External HMI for Automatic HMI (TPCOTH21)
- External HMI cable (TRV00810, TRV00820, TRV00830)
- IP 54 cover (TPCOTH37 / TPCOTH38)

### Controller Function Modules

The options and spare parts are:

- Load shedding and availability warning (TPCDIO05)
- Genset start and alarm (TPCDIO17)
- Source indication (TPCDIO19)
- Transfer inhibit and remote testing (TPCDIO07)
- Voluntary remote control (TPCDIO08)
- Fire protection
  - 24 V DC pulse (TPCDIO10)
  - 24 V DC constant (TPCDIO11)
  - 230 V AC constant (TPCDIO13)
  - 1 dry contact (TPCDIO14)
- BUS extension and 24 V DC auxiliary supply (TPCDIO15)
  - 24 V+ and 24 V- DC port
  - RJ45
- Modbus RTU (TPCCOM16)

### Switch Accessories

Accessories for the switch are as below:

- OF auxiliary contacts (wired) (TPSAUX32, TPSAUX33, TPSAUX43, TPSAUX44, TPSAUX71, TPSAUX72)

- Power connection accessories
  - Steel connectors (LV429242, LV429243)
  - Aluminum connectors (LV429227, LV429228, LV429259, LV429260, TPSCON47, TPSCON48, TPSCON49, TPSCON50, TPSCON51, TPSCON52, TPSCON53, TPSCON54)
  - Bare cable connectors (33640, 33641)
  - Vertical connection adapters (33642/LV833642SP, 33643/LV833643SP)
  - Straight terminal extensions (LV429263, LV429264)
  - Edgewise terminal extensions (LV429308, LV429309, TPSCON55, TPSCON56)
  - Spreaders (LV431563, LV431564, TPSCON39, TPSCON40, TPSCON41, TPSCON68, 33622/LV833622SP, 33623/LV833623SP)
  - Load extension bars (TPSCON35, TPSCON36)
  - Compression lug (LV429252, LV429253, LV429254, LV429256, LV429257, LV429258, LV429504, LV429505, LV429506, LV429507, TPSCON57, TPSCON58, TPSCON59, TPSCON60, TPSCON61, TPSCON62, TPSCON63, TPSCON64)
  - Cable-lug adapters (33644/LV833644SP, 33645/LV833645SP)
  - Linergy DP distribution block (LVS04033, LVS04034)
- Insulation accessories
  - Interphase barrier (TPSISO29, TPSISO65, TPSISO70)
  - Terminal shield (TPSISO30, TPSISO31)
  - Long terminal shield (LV429518, TPSISO42)
  - Insulating screen (TPSISO66, TPSISO67)
- Monitoring accessories
  - PowerTag (LV434021)
- Upside down installation kit (TPSOTH73)
- Operation handle for TransferPacT Active Automatic/Automatic/Remote 100–250, 320–630, 800 (TPSOTH69)
- Operation handle for TransferPacT Active Automatic/Automatic 32–100 (TPCOTH39)
- Operation handle for TransferPacT Active Automatic/Automatic 80–160 (TPCOTH40)

# Technical Characteristics

## What's in This Chapter

Weights .....	25
TransferPacT Switch Functions and Characteristics .....	26
TransferPacT Controller Functions and Characteristics .....	28
Assembly Matrix.....	31

## Weights

This section describes the weights of the TransferPacT Automatic, TransferPacT Active Automatic and TransferPacT Remote switches.

<b>Frame ratings</b>	<b>Weights</b>
Frame 100: 32– 100 A	3.4 kg
Frame 160: 80– 160 A	5.6 kg
Frame 250: 100– 250 A	13.3 kg
Frame 630: 320– 630 A	22.1 kg
Frame 800: 800 A	22.4 kg
Frame 1600: 800– 1250 A	69 kg
Frame 1600: 1600 A	72.3 kg

# TransferPacT Switch Functions and Characteristics

Functions and characteristics	Frame 100	Frame 160	Frame 250	Frame 630	Frame 800	Frame 1600	
Type of device	TSE PC type	TSE PC type	TSE PC type	TSE PC type	TSE PC type	TSE PC type	
Suitable for isolation	<input checked="" type="checkbox"/>	<input checked="" type="checkbox"/>	<input checked="" type="checkbox"/>	<input checked="" type="checkbox"/>	<input checked="" type="checkbox"/>	<input checked="" type="checkbox"/>	
<b>Electrical characteristics</b>							
Current rating (Ampere)	32, 40, 50, 63, 80*, 100* *: AC-32 B for 80 A and 100 A	80, 100, 125, 160	100, 160, 200, 250	320, 400, 500, 630	800	800, 1000, 1250, 1600	
Rated operational voltage	2P: 220/230/240/250 V L–N 3P, 4P: 380/400/415/440 V L–L	3P, 4P: 380/400/415/440 V L–L	3P, 4P: 208/220/230/240V L–L 380/400/415/440 V L–L	3P, 4P: 208/220/230/240V L–L 380/400/415/440 V L–L	3P, 4P: 208/220/230/240V L–L 380/400/415/440 V L–L	3P, 4P: 380/400/415/440 V L–L	
Number of poles	2, 3, 4	3, 4	3, 4	3, 4	3, 4	3, 4	
Frequency (Hz)	50 / 60	50 / 60	50 / 60	50 / 60	50 / 60	50 / 60	
Insulating voltage $U_i$ (V AC) switch only	800	800	800	800	1000	1000	
Impulse withstand voltage $U_{imp}$ (kV AC) switch only	6	8	8	12	12	12	
Rated short-circuit making capacity $I_{cm}$ (kA)	Switch alone	15	20	30	40	40	105
	with upstream circuit breaker	75	154	330	330	330	330 / 154
Rated short-time withstand current $I_{cw}$ (kA)	5 kA/0.1 s	10 kA/0.1 s	15 kA/0.1 s, 10 kA/0.5 s, 8 kA/1 s	25 kA/0.1 s, 20 kA/0.5s, 15 kA/1 s	25 kA/0.1 s, 20 kA/0.5s, 15 kA/1 s	50 kA/0.5 s, 70 kA/0.1s	
Utilization category	AC-33B	AC-33B	AC-33B	AC-33B	AC-33B	AC-33B	
Operating temperature (°C)	-25– +70	-25– +70	-25– +70	-25– +70	-25– +70	-25– +70	
<b>Operational characteristics</b>							
Maintenance mechanical durability	8000 cycles	10000 cycles	10000 cycles	10000 cycles	10000 cycles	10000 cycles	
Additional Indication and control auxiliaries							
Auxiliary contacts for N and A position	<input type="checkbox"/>	<input type="checkbox"/>	<input type="checkbox"/>	<input type="checkbox"/>	<input type="checkbox"/>	<input type="checkbox"/>	
Auxiliary contacts for OFF position	<input type="checkbox"/>	<input type="checkbox"/>	<input type="checkbox"/>	<input type="checkbox"/>	<input type="checkbox"/>	<input type="checkbox"/>	
<b>Installation and connection</b>							
Fixed top connection	<input checked="" type="checkbox"/>	<input checked="" type="checkbox"/>	<input checked="" type="checkbox"/>	<input checked="" type="checkbox"/>	<input checked="" type="checkbox"/>	<input checked="" type="checkbox"/>	
Installation method	DIN Rail/Base Plate	DIN Rail/Base Plate	Base Plate	Base Plate	Base Plate	Base Plate	
Installation and connection accessories							
Terminal shields	<input type="checkbox"/>	<input type="checkbox"/>	<input type="checkbox"/>	<input type="checkbox"/>	<input type="checkbox"/>	-	
Inter-phase barriers	-	<input type="checkbox"/>	<input type="checkbox"/>	<input type="checkbox"/>	<input type="checkbox"/>	<input type="checkbox"/>	
Power connectors	<input type="checkbox"/>	<input type="checkbox"/>	<input type="checkbox"/> *	<input type="checkbox"/> *	<input type="checkbox"/> *	<input type="checkbox"/> *	

Functions and characteristics	Frame 100	Frame 160	Frame 250	Frame 630	Frame 800	Frame 1600
<b>Shipping information</b>						
Net weight (kg)	3.4	5.6	13.3	22.1	22.4	72.3
Dimension L * W * D (mm)	155 * 310 * 94.3	164 * 351 * 95	370 * 341 * 186	467 * 341 * 186	467 * 341 * 186	540 * 391 * 383.5
* Refer to the power connection for more details.						

**NOTE:**

- : Standard function.
- : Optional function.

## TransferPacT Controller Functions and Characteristics

Functions and characteristics		Active Automatic version with LCD display	Automatic version with rotary switch	Remote version without HMI switch
Installation		Embedded controller	Embedded controller	-
<b>Controller functional characteristics</b>				
2P		230 V: can be set at 220 V / 240 V / 250 V (L-N, available for Frame 100)	230 V: can be set at 220 V / 240 V / 250 V (L-N, available for Frame 100)	
3P / 4P		230 V: can be set at 208 V / 220 V / 240 V (L-L, available for Frame 250 and 630)	400 V: can be set at 380 V / 415 V / 440 V	230 V: 208 V / 220 V / 240 V (L-L, available for Frame 250 and 630)
		400 V: can be set at 380 V / 415 V / 440 V		400 V: 380 V / 415 V / 440 V
Rated operating frequency (Hz)		50/60	50/60	50/60
Rated insulation voltage (V)		500	500	500
Impulse withstand voltage (kV)		6	6	6
Operating temperature (°C)		-25– +70	-25– +70	-25– +70
Operating altitude (m)		≤ 2000	≤ 2000	≤ 2000
Protection degree		IP 20	IP 20	IP 20
Pollution degree		3	3	3
Accuracy (for power deviation)	Voltage	1 %	1 %	-
	Frequency	0.1 %	0.1 %	-
Electrostatic discharge		Level 4	Level 4 <sup>(1)</sup>	Level 4
Radio-frequency electromagnetic field		Level 3	Level 3	Level 3
Fast transient bursts		Level 4	Level 4	Level 4
Surges		Level 4	Level 4	Level 4
Harmonic wave		Class 3	Class 3	Class 3
Voltage dips and short-time interruptions		Class 3	Class 3	Class 3
Vibration		IEC 60068-2-6	IEC 60068-2-6	IEC 60068-2-6
Shock		IEC 60068-2-27	IEC 60068-2-27	IEC 60068-2-27
<b>Display of controller</b>				
Display mode		LCD + LED + indicator	Rotary switch + DIP switch + LED + indicator	LED + indicator
Single line diagram		■	■	
Language		English/Chinese/French/Russian/Spanish/Italian/German/Portuguese	-	-
Power status		■	■	■ Run/Alarm display
Position for contact		■	■	-
Set value		Button	Rotary switch + DIP switch	-
<b>Control mode</b>				
Auto	Auto return	■	■	-
	Non return	■	■	-
Non-Auto	Handle	■	■	-

(1) Close the plastic cover.

Functions and characteristics		Active Automatic version with LCD display	Automatic version with rotary switch	Remote version without HMI
	Force	<input type="checkbox"/>	<input type="checkbox"/>	-
	Fire	<input type="checkbox"/>	<input type="checkbox"/>	-
	Inhibit	<input type="checkbox"/>	<input type="checkbox"/>	-
	Local	<input checked="" type="checkbox"/>	-	-
	Voluntary	<input type="checkbox"/>	<input type="checkbox"/>	-
	Test	<input checked="" type="checkbox"/>	<input type="checkbox"/>	-
<b>Auto control</b>				
Sampling		Three Phase for both normal and alternate	Three Phase for both normal and alternate	-
Voltage loss		< 36 V	< 36 V	-
Phase loss		L1, L2, L3	L1, L2, L3	-
Under voltage	Set value	70– 95%	4%, 6%, 8%, 10%, 12%, 14%, 16%, 18%, 20%	-
Over voltage	Set value	105– 135%	4%, 6%, 8%, 10%, 12%, 14%, 16%, 18%, 20%	-
Under frequency	Set value	80– 98%	2%, 3%, 4%, 5%, 6%, 7%, 8%, 9%, 10%	-
Over frequency	Set value	101– 120%	2%, 3%, 4%, 5%, 6%, 7%, 8%, 9%, 10%	-
Unbalance of three phase voltage		2– 30%	-	-
Phase rotation		Yes	-	-
<b>Time delay</b>				
Transfer delay (s)		0– 1800	U-U: 0, 1, 2, 3, 5, 10, 20, 30, 60 U-G: 5	-
Re-transfer delay (s)		0– 3600	0, 1, 2, 3, 5, 10, 20, 30, 60 min	-
Center-off delay (s)		0– 30	0 or 5	-
Genset start delay (s)		0– 120	0, 1, 2, 3, 5, 10, 20, 30, 60	-
Genset cool down delay (s)		0– 3600	-	-
Load shedding delay (s)		0– 15	-	-
Genset ready alarm delay (s)		15– 300	300	-
Test delay (s): on load		1– 1800	-	-
Test delay (s): off load		1– 1800	-	-
<b>Other Functions</b>				
Calender time		<input checked="" type="checkbox"/>	-	-
Position feedback		<input type="checkbox"/>	<input type="checkbox"/>	<input type="checkbox"/>
Event log		<input checked="" type="checkbox"/>	-	-
Source priority		<input checked="" type="checkbox"/>	<input checked="" type="checkbox"/>	-
Communication		Modbus RTU	-	-
Transfer Inhibit		<input type="checkbox"/>	<input type="checkbox"/>	-
Password protection		<input checked="" type="checkbox"/>	-	-
Gen start-stop		<input type="checkbox"/>	<input type="checkbox"/>	-
Test		<input checked="" type="checkbox"/>	<input type="checkbox"/>	-
Load shedding		<input type="checkbox"/>	<input type="checkbox"/>	-
Fire protection		<input type="checkbox"/>	<input type="checkbox"/>	-
Failure lock		<input checked="" type="checkbox"/>	<input checked="" type="checkbox"/>	<input checked="" type="checkbox"/>

Functions and characteristics	Active Automatic version with LCD display	Automatic version with rotary switch	Remote version without HMI
Alarm indication	■	■	■
External power supply port	■	-	-
Wrong connection of neutral alarm	■	-	-
Transient transfer current	Frame 100: 10 A Frame 160: 10 A Frame 250: 15 A Frame 630: 30 A Frame 800: 30 A Frame 1600: 10 A		

## Assembly Matrix

Device	Type of HMI	Number of poles	Voltage	Type of connection	Rated current
Frame 100	Active Automatic HMI (LCD)	2	220 / 230 / 240 / 250 V	Top	32 A, 40 A, 50 A, 63 A, 80 A, 100 A
		3 / 4	380 / 400 / 415 / 440 V		
	Automatic HMI (Rotary and DIP switch)	2	220 / 230 / 240 / 250 V		
		3 / 4	380 / 400 / 415 / 440 V		
Frame 160	Active Automatic HMI (LCD)	3 / 4	380 / 400 / 415 / 440 V	Top	80 A, 100 A, 125 A, 160 A
	Automatic HMI (Rotary and DIP switch)				
Frame 250	Active Automatic HMI (LCD)	3 / 4	208 / 220 / 230 / 240 / 380 / 400 / 415 / 440 V	Top	100 A, 160 A, 200 A, 250 A
	Automatic HMI (Rotary and DIP switch)				
	Remote				160 A, 200 A, 250 A
Frame 630	Active Automatic HMI (LCD)	3 / 4	208 / 220 / 230 / 240 / 380 / 400 / 415 / 440 V	Top	320 A, 400 A, 500 A, 630 A
	Automatic HMI (Rotary and DIP switch)				
	Remote				
Frame 800	Active Automatic HMI (LCD)	3 / 4	208 / 220 / 230 / 240 / 380 / 400 / 415 / 440 V	Top	800 A
	Automatic HMI (Rotary and DIP switch)				
	Remote				
Frame 1600	Active Automatic HMI (LCD)	3 / 4	380 / 400 / 415 / 440 V	Top	800 A, 1000 A, 1250 A, 1600 A

# TransferPacT Controller

## What's in This Chapter

TransferPacT Transfer Switching Equipment Overview .....	33
Controller Function Module .....	34
Input and Output Terminal Functions for TransferPacT Remote .....	55

## TransferPacT Transfer Switching Equipment Overview

TransferPacT ATSE is provided with an advanced microprocessor controller with two options:

- Active automatic HMI (LCD display and keypad)
- Automatic HMI (Rotary and DIP switch)

It is a robust and reliable controller which offers all of the voltage, frequency, control, timing and diagnostic functions required for wide range of power applications.

The Automatic HMI is easy to install and use, while Active Automatic HMI contains every function needed with eight control modes.

There are two key features of TransferPacT ATSE controller:

- Automatic HMI can be hot swapped to Active Automatic HMI, an easy way to upgrade your controller. HMI can also be easily replaced for maintenance or renewal.
- 10 types of function modules can be installed on TransferPacT ATSE controller at any time, which provides maximum scalability, reduced total cost of ownership, and add functions with growing demands..

TransferPacT RTSE has intelligent control with CPU integrated in switch, it is provided with:

- Input and output terminals

Besides the terminals for I/O signals, it also provides power state, product state and alarm indication through LED indicator on product front face.

TransferPacT RTSE is designed to manage the transfer according to the incoming command of the third party. It can work with third party system, like generator-set controllers, PLCs etc.

# Controller Function Module

The controller function module is used to extend the interactive function of the TransferPacT ATSE.

TransferPacT ATSE provides the source changeover solution with controller function modules to upgrade without interruption of power.

The controller function module has three core parts:

- **Rotary cover:** Open the rotary cover to access to power terminals.
- **LED:** It is used to indicate the power status and connection of the accessories.
  - Green LED: Indicates that the accessories are powered and properly connected.
  - OFF: Indicates that the accessories are not live except for bus extension and 24 VDC auxiliary supply module (TPCDIO15).
  - ON: Indicates there is an external 24 VDC power supply.
- **Power terminals:** It is used for wiring.

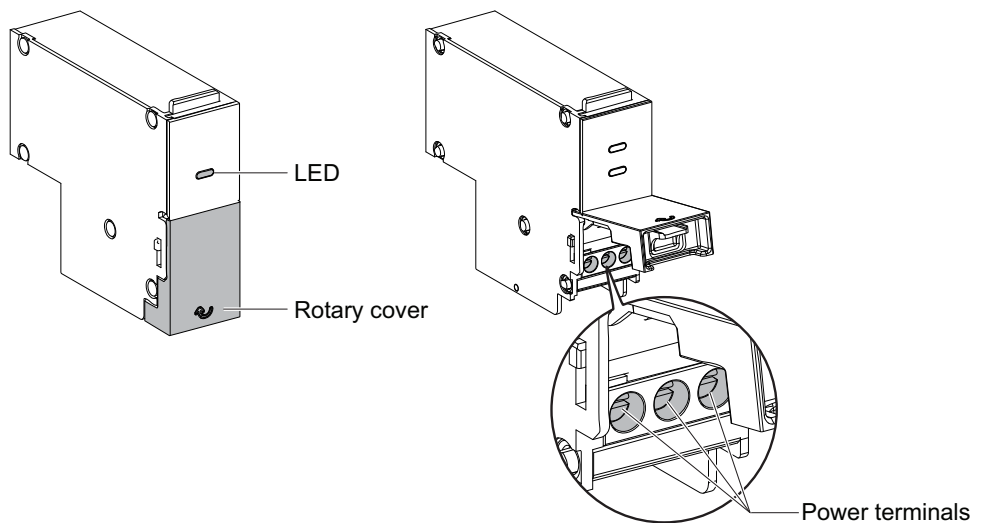

**NOTE:** Controller function modules are only supported by TransferPacT Active Automatic and TransferPacT Automatic Transfer switching equipment.

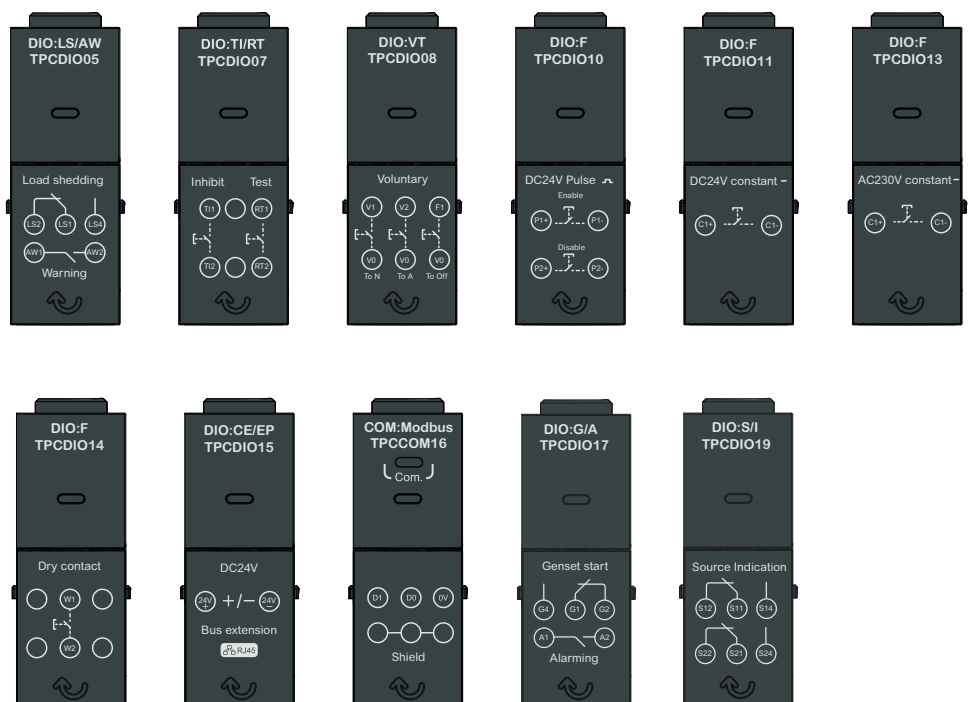

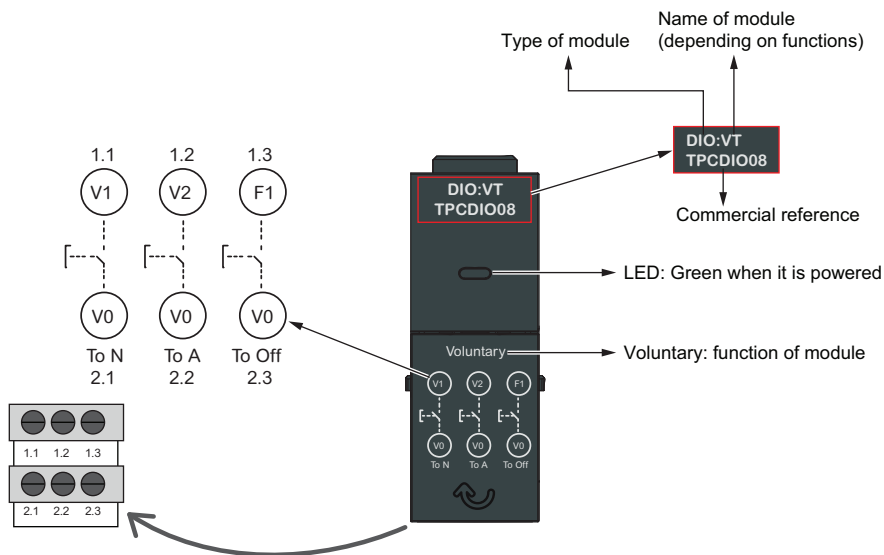

The details of the terminals of function modules are shown below:

Commercial Reference	Description	Wiring terminals						Notes
TPCDIO05	Load shedding and availability warning	1.1	1.2	1.3	2.1	2.2	2.3	
		LS2	LS1	LS4	AW1		AW2	LS: load shedding AW: available warning
TPCDIO07	Transfer inhibit and remote testing	1.1	1.2	1.3	2.1	2.2	2.3	
		TI1		RT1	TI2		RT2	TI: transfer inhibit RT: remote testing
TPCDIO08	Voluntary remote control	1.1	1.2	1.3	2.1	2.2	2.3	
		V1	V2	F1	V0	V0	V0	V: voluntary remote control
TPCDIO10	Fire protection-24 VDC pulse input	1.1	1.2	1.3	2.1	2.2	2.3	
		P1+		P1-	P2+		P2	P: pulse input
TPCDIO11	Fire protection-24 VDC constant input	1.1	1.2	1.3	2.1	2.2	2.3	
		C1+		C1-				C: constant input
TPCDIO13	Fire protection-230 VAC constant input	1.1	1.2	1.3	2.1	2.2	2.3	
		C1+		C1-				C: constant input
TPCDIO14	Fire protection-1 dry contact input	1.1	1.2	1.3	2.1	2.2	2.3	
			W1			W2		W: dry contact
TPCDIO15	BUS extension and 24 VDC auxiliary supply	1.1	1.2	1.3	2.1	2.2	2.3	
		24 V+		24 V-	RJ45			RJ45: Bus extension 24V+ / 24V-: external power
TPCCOM16	Modbus RTU (Serial Port)	1.1	1.2	1.3	2.1	2.2	2.3	
		D1	D0	0V	Shield			Modbus: Modbus communication
TPCDIO17 (version 1)	Genset start and alarm	1.1	1.2	1.3	2.1	2.2	2.3	
		G2	G1	G4	A1		A2	G: Genset control A: alarm

Commercial Reference	Description	Wiring terminals						Notes
		1.1	1.2	1.3	2.1	2.2	2.3	
TPCDIO17 (version 2)	Genset start and alarm	1.1	1.2	1.3	2.1	2.2	2.3	G: Genset control A: alarm
		G4	G1	G2	A1		A2	
TPCDIO19	Source indication	1.1	1.2	1.3	2.1	2.2	2.3	S: Source
		S12	S11	S14	S22	S21	S24	

For information on installation of function modules, consult the instruction sheets on Schneider Electric website:

- TransferPacT Active Automatic / Automatic 32-100 A: JYT3049801
- TransferPacT Active Automatic / Automatic 80-160 A: JYT3049901
- TransferPacT Active Automatic / Automatic / Remote 100–250 A: GEX2525501
- TransferPacT Active Automatic / Automatic / Remote 320–630 A: GEX2525601
- TransferPacT Active Automatic / Automatic / Remote 800 A: BQT1751501
- TransferPacT Active Automatic 800–1600 A: BQT7680301

## Function Module Package Details

In the packaging box, the function module and light instruction are provided.

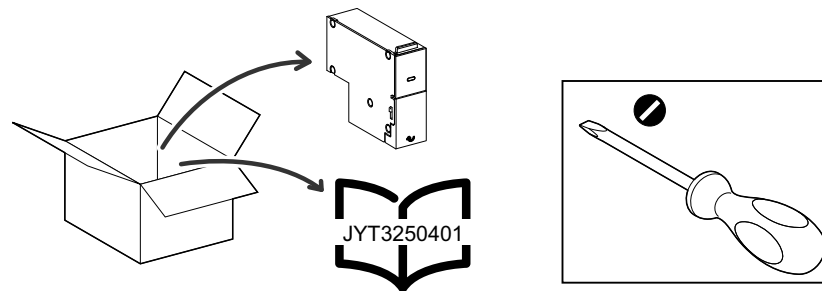

## Voluntary Remote Control

The voluntary remote control is an accessory module installed on TransferPacT Automatic and TransferPacT Active Automatic controller with the following functions:

- Voluntary remote control to N or A, 2 NO contacts are provided.
- Force to off, 1 NO contact is provided.
- Green LED on the front face of the accessory indicates the power status and proper connection of the accessory.
- Communication with the main MCU on ATSE.
- Only one voluntary remote controller module is allowed to be installed on the product.

### Application Voluntary to N or A

Voluntary transfer is an active input which can transfer the ATSE to normal or alternate source according to requirements (such as energy saving).

Voluntary transfer will still keep the power continuity as much as possible. The function will be bypassed, if target source lost the power. For example, after voluntary to A while A source failed, ATSE will transfer back to N if N is available.

Exit the voluntary mode after signal disappeared.

### Force to Off

Force to Off is an emergency stop order, to transfer the ATSE to off position. All the other transfer mode will be canceled except handle control.

Exit Force to Off after signal disappeared.

### Terminals

There are three terminals of the voluntary remote controller modules as below:

- V1-V0: voluntary to N
- V2-V0: voluntary to A
- F1-V0: force to Off

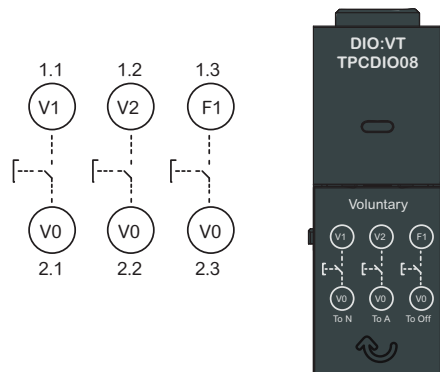

### Signal Type

- Digital input with dry contact.
- Need over 200 ms input to start voluntary remote control.

## Performance

Electrical characteristics	Ratings
Ui	30 VDC
Minimum input current	5 mA
Altitude	2000 m

## Cable Capacity for Terminals

The cable capacity for the terminals are 0.05 – 2.6 mm<sup>2</sup> (AWG 30 ~ 13).

## Genset Start and Alarm

The Genset start and Alarm is an accessory module installed on TransferPacT Automatic and TransferPacT Active Automatic controller with following functions:

- Genset output control with optional time delay function, 1 NC and 1 NO dry contacts are provided.
- Alarm output, 1 NO dry contact is provided.
- Green LED on the top of the accessory indicates the power status and proper connection of the accessory.
- Communication with the main MCU on ATSE.
- Only one Genset start (with capacitor) and alarm is allowed to be installed on one product.

## Application Genset Start Output

When the utility source is lost, a dry contact will start the Genset irrespective of external 24 VDC. A time delay (T7) before Genset start can be set with or without external 24 V. If the time delay (T7) is longer than 60 s, it is mandatory to have an external 24 VDC power supply.

**NOTE:** When the genset start signal is sent out, the genset is considered as out of range before it gets ready.

When the utility source has recovered and ATSE has transferred back to utility, the Genset signal will remain until the end of the Genset cooldown timer.

## Alarm

When there is an alarm, a dry contact will give the signal.

The alarm signal is irrelevant to Genset start or stop. It is relevant to transfer errors and phase rotations errors listed in [Alarm Message](#), page 215.

For TransferPacT Automatic, restart the controller (open and close the dielectric door) to shut down the alarm.

For TransferPacT Active Automatic, refer to [Alarm](#), page 214 and follow the procedures to acknowledge the alarm.

**NOTE:** Contact field service first to record the alarm. Then try the procedures above in case of emergency.

## Terminals

For Genset start: 1 NO + 1 NC:

- NO: G1-G4
- NC: G1-G2

When Genset start initiates, NC terminal will close, and NO terminal will open.

Alarm: 1 NO

- NO : A1-A2

When alarm initiates, NO terminal will close.

**Version 1**

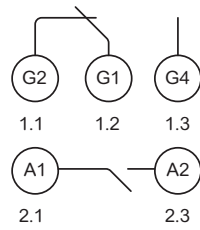

**Version 2**

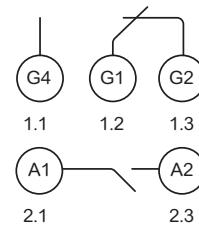

**NOTE:** The G2 and G4 terminals are swapped on two versions. Please inspect the label on the rotary cover to locate the positions.

**Signal Type**

Digital output.

**Performance**

Electrical characteristics	Ratings
U <sub>i</sub>	300 V
Maximum output voltage	250 VAC, 50 / 60 Hz or 30 VDC
Maximum output current	5 A
Over voltage category	III
Pollution degree	3
Altitude	2000 m

**Cable Capacity for Terminals**

The cable capacity for the terminals are 0.05 – 2.6 mm<sup>2</sup> (AWG 30 ~ 13).

## Source Indication

The source indication is a function module installed on TransferPacT Automatic and TransferPacT Active Automatic controller with following functions:

- Source availability indication, 2 NC and 2 NO dry contacts are provided.
- Green LED on the top of the accessory indicates the power status and proper connection of the accessory.
- Communication with the main MCU on ATSE.
- Only one source indication module is allowed to be installed on one product.

## Source Availability Output

The function is used for checking source I and source II status. User can wire indicators to this function module to check source availability without opening the panel or wiring external HMI.

It provides two types of output for each source:

- Source I/II in range output
- Source I/II out of range output

**NOTE:** In U-G application, the output will not indicate any error in genset.

## Terminals

For source I indication: 1 NO + 1 NC:

- NO: S11-S14
- NC: S11-S12

For source II indication: 1 NO + 1 NC:

- NO: S21-S24
- NC: S21-S22

When the source is in range, NC terminal will close, and NO terminal will open.

When the source is out of range, or there is no voltage, NC terminal will open, and NO terminal will close.

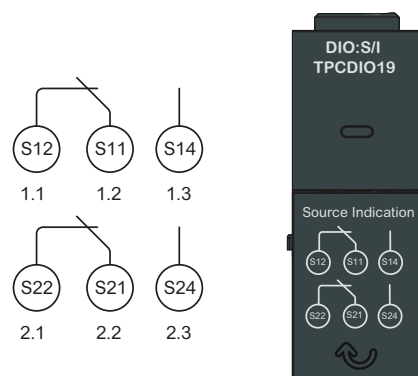

## Signal Type

Digital output/ dry contact

## Performance

Electrical characteristics	Ratings
Ui	300 V
Maximum output voltage	250 Vac, 50 / 60 Hz or 30 Vdc
Maximum output current	5 A
Over voltage category	III
Pollution degree	3
Altitude	2000 m

## Load Shedding and Availability Warning

The load shedding and availability warning is an accessory module installed on TransferPacT Automatic and TransferPacT Active Automatic controller with following functions:

- Load shedding output, 1 NO and 1 NC dry contacts is provided.
- Available warning, 1 NO dry contact is provided.
- Green LED is on the top of the accessory indicates the power status and proper connection of the accessory.
- Communication with the main MCU on ATSE.
- Only one load shedding and availability warning is allowed to be installed on one product.

### Application Load Shedding

The alternate power (genset) sometimes may not afford all loads. A signal from controller will shed some non-critical loads.

Load shedding will send the signal after enabling this function.

### Application Availability Warning

When transfer switch is not in auto or power lost on two sources, a dry contact will give the signal.

After back to auto status or power recovery, the signal will be stopped.

## Terminals

Load shedding: 1 NO + 1 NC

- NO: LS1-LS4
- NC: LS1-LS2

When load shedding initiates, NC terminal will open, and NO terminal will close.

For status output: 1 NO

- NO: AW1-AW2

When availability warning initiates, NO terminal will close.

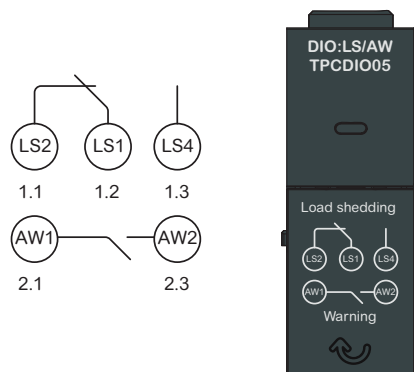

## Signal Type

Digital output.

## Performance

Electrical characteristics	Ratings
Ui	300 V
Maximum output voltage	250 VAC, 50 / 60 Hz or 30 VDC
Maximum output current	5 A
Over voltage category	III
Pollution degree	3
Altitude	2000 m

## Cable Capacity for Terminals

The cable capacity for the terminals are 0.05 – 2.6 mm<sup>2</sup> (AWG 30 ~ 13).

## Transfer Inhibit and Remote Testing

The transfer inhibit and remote testing is an accessory module installed on TransferPacT Automatic and TransferPacT Active Automatic controller with following functions:

- Transfer inhibit, 1 NO dry contact is provided.
- Remote testing, 1 NO dry contact is provided.
- Green LED on the top of the accessory indicates the power status and proper connection of the accessory.
- Communication with the main MCU on ATSE.
- Only one transfer inhibit and remote testing module is allowed to be installed on each TSE.

### Application Transfer Inhibit

- Transfer Inhibit when there is power interruption because of short circuit.
- This function can be used to lock the controller by customized signals.
- This function can be used for cooperation with different ATSE.
- Remove transfer inhibit signal to exit this mode.

### Application Remote Testing

- Remote testing is an input signal to start test procedure.
- The remote test can only be started at Auto mode.
- For Active Automatic HMI, on load test, off load test and time duration can be selected.
- For Automatic HMI, on load test is unlimited. Stop the test manually by opening the dielectric switch on ATSE, and it should be back in run position to resume the controller function.

## Terminals

For transfer inhibit: 1 input

- Inputs : TI1-TI2

For remote testing: 1 input

- Inputs : RT1-RT2

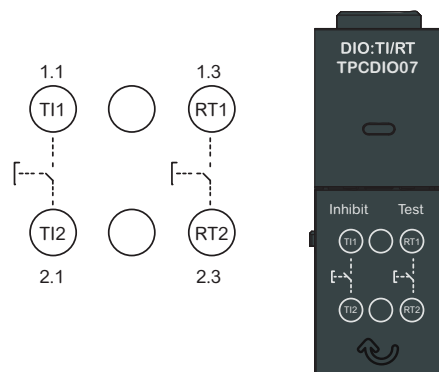

## Signal Type

- Digital input with dry contact
- Need over 200 ms input to start transfer inhibit and remote test

## Performance

Electrical characteristics	Ratings
Ui	30 V DC
Maximum Input current	5 mA
Altitude	2000 m

## Cable Capacity for Terminals

The cable capacity for the terminals are 0.05 – 2.6 mm<sup>2</sup> (AWG 30 ~ 13).

## BUS Extension and 24 VDC Auxiliary Supply

The BUS extension and 24 VDC auxiliary supply is an accessory module installed on TransferPacT Active Automatic controller with following functions:

- Bus extension, 1 RJ45 is provided.
- DC 24 V and 1 input is provided.
- Green LED on the front face of the accessory indicates the power status and proper connection of the accessory.
- Communication with the main MCU on ATSE.
- Only one BUS extension and DC 24 V auxiliary supply is allowed to be installed on one product, in the right most slot.

### Application BUS Extension

BUS extension is used to connect external HMI.

### Application with DC 24 V

- External power for controller when both source failure.
- External power to keep power for Modbus communication when both source failure.

### Terminals

For BUS Extension

- RJ45

DC 24 V

- 24 V+, 24 V-

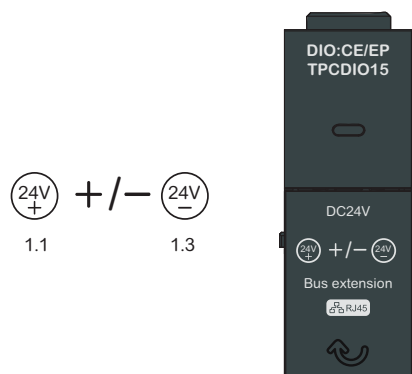

### Signal Type

Power supply and bus extension.

## Performance

Electrical characteristics	Ratings
U <sub>i</sub>	30 V DC
Maximum Input voltage	28.8 V DC
Minimum input voltage	19.2 V DC
Maximum input current	1 A
Pollution degree	3
Altitude	2000 m
RJ45	CAT 3

## Cable Capacity for Terminals

The cable capacity for the terminals are as below:

- The cable capacity for the terminals are 0.05 – 2.6 mm<sup>2</sup> (AWG 30 ~ 13).
- RJ45

## Fire Protections 24 V DC Pulse Input

The fire protection is an accessory module installed on TransferPacT Automatic and TransferPacT Active Automatic controller with following functions:

- Exit the auto transfer mode and transfer the switch to OFF according to input signal.
- Fire protection with input of DC 24 V pulse signal.
- Green LED on the front face of the accessory indicates the power status and proper connection of the accessory.
- The main MCU on ATSE communication through CAN bus.
- Only one module is allowed to be installed on one product.

### Application

When there is fire emergency, the fire protection signal can transfer ATSE to off position.

### Terminals

- Fire protection with 24 V DC Pulse:
  - Start: P1+.P1-
  - Exit: P2+,P2-

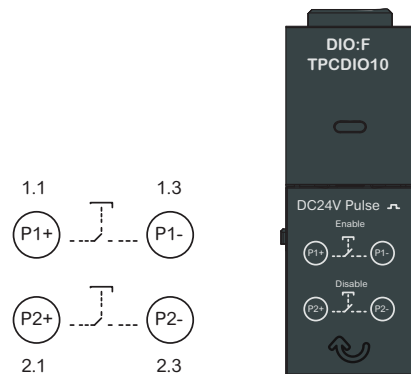

### Performance

Electrical characteristics	Ratings
Ui	30 V DC
Maximum input voltage (fire enable)	28.8 V DC
Minimum input voltage (fire enable)	19.2 V DC
Maximum input voltage (fire disable)	28.8 V DC
Minimum input voltage (fire disable)	19.2 V DC
Maximum input current	10 mA
Over voltage category	II
Pollution degree	3
Altitude	2000 m

### Cable Capacity for Terminals

The cable capacity for the terminals are 0.05 – 2.6 mm<sup>2</sup> (AWG 30 ~ 13).

## Fire Protection 24 V DC Constant Input

The fire protection is an accessory module installed on TransferPacT Automatic and TransferPacT Active Automatic controller with following functions:

- Exit the auto transfer mode and transfer the switch to OFF according to input signal.
- Fire protection with input of 24 V DC constant signal.
- Green LED on the front face of the accessory indicates the power status and proper connection of the accessory.
- The main MCU on ATSE communication through CAN bus.
- Only one module is allowed to be installed on one product.

## Application

When there is fire emergency, the fire protection signal can transfer ATSE to OFF position.

## Terminals

- Fire protection with 24 V DC constant signal:
  - C1+.C1-

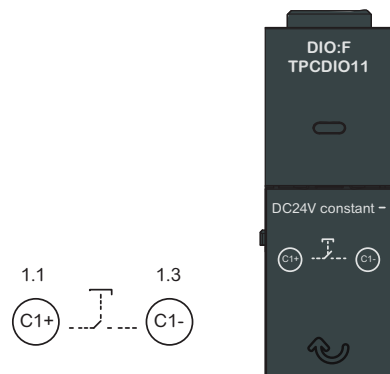

## Performance

Electrical characteristics	Ratings
Ui	30 V DC
Maximum input voltage (fire enable)	28.8 V DC
Minimum input voltage (fire enable)	19.2 V DC
Maximum input current	10 mA
Over voltage category	II
Pollution Degree	3
Altitude	2000 m

## Cable Capacity for Terminals

The cable capacity for the terminals are 0.05 – 2.6 mm<sup>2</sup> (AWG 30 ~ 13).

## Fire Protection 230 V AC Constant Input

The fire protection is an accessory module installed on TransferPacT Automatic and TransferPacT Active Automatic controller with following functions:

- Exit the auto transfer mode and transfer the switch to OFF according to input signal.
- Fire protection with input of 230 V AC constant.
- Green LED on the front face of the accessory indicates the power status and proper connection of the accessory.
- The main MCU on ATSE communication through CAN bus.
- Only one module is allowed to be installed on one product.

### Application

When there is fire emergency, the fire protection signal can transfer ATSE to OFF position.

### Terminals

- Fire protection with input of 230 V AC constant.
  - C1+.C1-

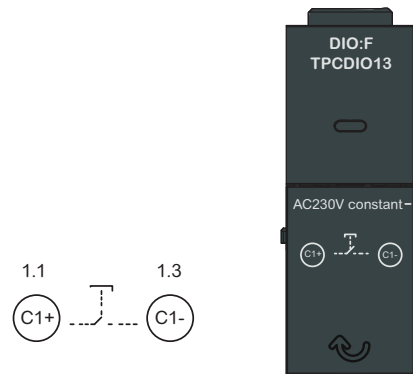

### Performance

Electrical characteristics	Ratings
Ui	300 V
Maximum input voltage (fire enable)	276 V AC
Minimum input voltage (fire enable)	184 V AC
Maximum input current	10 mA
Over voltage category	II
Pollution degree	3
Altitude	2000 m

### Cable Capacity for Terminals

The cable capacity for the terminals are 0.05 – 2.6 mm<sup>2</sup> (AWG 30 ~ 13).

## Fire Protection Dry Contact Input

The fire protection is an accessory module installed on TransferPacT Automatic and TransferPacT Active Automatic controller with following functions:

- Exit the auto transfer mode and transfer the switch to OFF according to input signal.
- Fire protection with 1 dry contact input.
- Green LED on the front face of the accessory indicates the power status and proper connection of the accessory.
- The main MCU on ATSE communication through CAN bus.
- Only one module is allowed to be installed on one product.

## Application

When there is fire emergency, the fire protection signal can transfer ATSE to off position.

## Terminals

- Fire protection with 1 dry contact input:
  - W1.W2

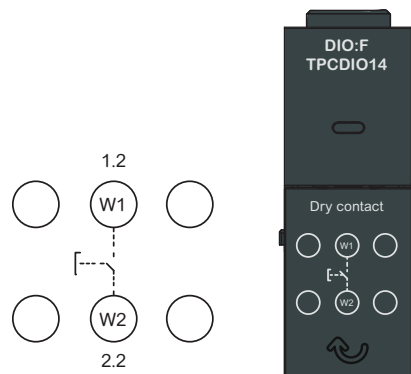

## Performance

Electrical Characteristics	Ratings
U <sub>i</sub>	30 Vdc
Minimum input current	5 mA
Altitude	2000 m

## Cable Capacity for Terminals

The cable capacity for the terminals are 0.05 – 2.6 mm<sup>2</sup> (AWG 30 ~ 13).

## Modbus RTU (Serial Port)

The modbus is an accessory module installed on TransferPacT Active Automatic controller with following functions:

- Modbus RTU communication supporting MODBUS protocol.
- Indicate the com status of the accessory by using a yellow LED on top of the accessory.
- Green LED on the front face of the accessory indicates the power status and proper connection of the accessory.
- Communication with the main MCU on ATSE.
- Support communication transfer.
- Two Modbus are allowed to be installed on one product.

## Application Modbus

Modbus can be used to connect with other system. It require external 24 V or at least one main source to keep the communication with protocol Modbus RTU.

For a cable length up to 300 m (1.000 ft), it is mandatory to use a shielded twisted cable. The shield of cable is connected to the shield terminal.

## Terminals Modbus

- Modbus:
  - D1, D0, 0V, Shield

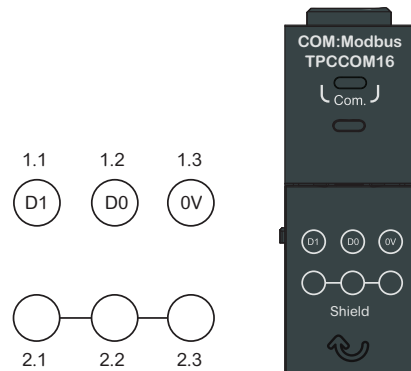

## Signal Type

Serial port.

## Performance











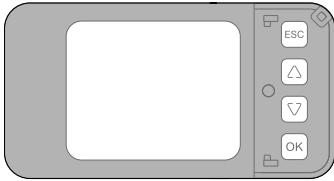
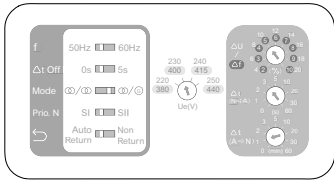











Electrical Characteristics	Ratings
Ui	30 V DC
Baud Rate (KBS)	4.8 / 9.6 / 19.2
Over voltage category	III
Pollution degree	3
Altitude	2000 m

## Cable Capacity for Terminals

The cable capacity for the terminals are 0.05 – 2.6 mm<sup>2</sup> (AWG 30 ~ 13).

## Limitation of Accessories

Type	Max
DI-Fire (including 4 fire type)	1
DI-Inhibit	1
DI-Voluntary	1
DI-Inhibit and test	1
DO-Load shedding and availability	1
DO-Genset start and alarm	1
Modbus	2

		TransferPacT Active Automatic	TransferPacT Automatic
 Impossible			
 Possible			
TPCDIO05	DO (Load Shedding and Availability)		
TPCDIO07	DI (Inhibit and Test)		
TPCDIO08	DI (Voluntary)		
TPCDIO10	Fire Protection (24 V Pulse)		
TPCDIO11	Fire Protection (24 V Constant)		
TPCDIO13	Fire Protection (230 V Constant)		
TPCDIO14	Fire Protection (Dry Contact)		
TPCDIO15	BUS Extension and 24 V DC Auxiliary Supply		
TPCCOM16	Modbus RTU (Serial Port)		
TPCDIO17	DO (Genset Start and Alarm)		

# Input and Output Terminal Functions for TransferPacT Remote

## Overview

TransferPacT Remote provides transfer solutions with input and output terminals.

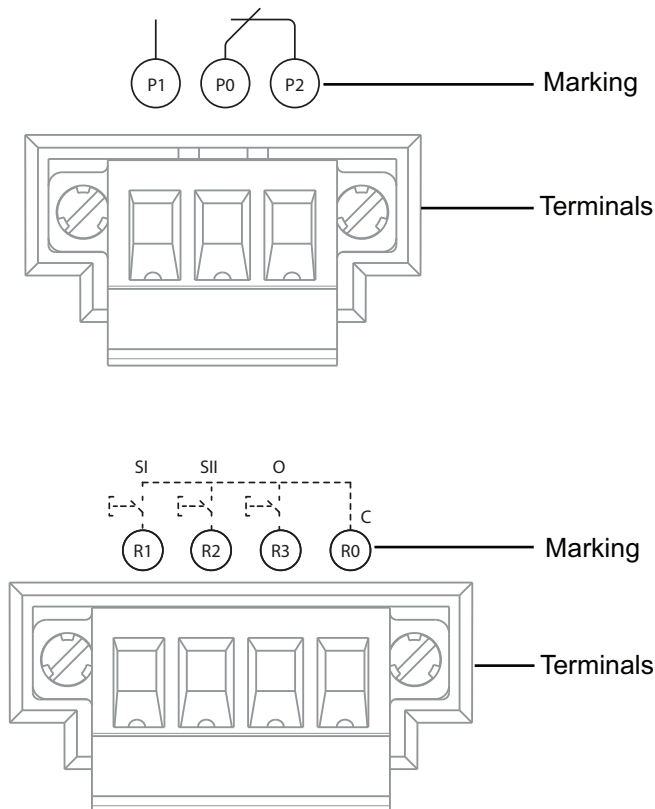

The details of the input and output terminals are shown below:

Terminals	Marking	Definition
Product Availability	P0	Common terminal for P1, P2
	P1	Output signal, when either source voltage is in range and product is NOT in manual mode, NO terminal will close.
	P2	Output signal, when either source voltage is in range and product is NOT in manual mode, NC terminal will open.
Remote Transfer	R0	Common terminal for R1, R2, R3
	R1	Passive input signal, remote transfer to position I when closed with R0 and last for at least 200 ms.
	R2	Passive input signal, remote transfer to position II when closed with R0 and last for at least 200 ms.
	R3	Passive input signal, remote transfer to position O when closed with R0 and last for at least 200 ms.

For information on installation of input and output terminals, consult the instruction sheets on Schneider Electric website:

- TransferPacT Active Automatic / Automatic / Remote 100–250 A: GEX2525501
- TransferPacT Active Automatic / Automatic / Remote 320–630 A: GEX2525601
- TransferPacT Active Automatic / Automatic / Remote 800 A: BQT1751501

## Product Availability

Product availability is a fixed function for TransferPacT remote with following functions:

- Dry contact output which can provide the product availability state.
- One NO and one NC are provided.

## Application

When either source is in range, and transfer switch equipment is not in manual mode, the normal open contact will close, normal closed contact will open. The table below lists the supported voltage deviation range for RTSE.

Rated voltage of RTSE	Supported voltage range
380–440 V	274 - 517 V
208–240 V	174 - 280 V

When both sources are out of range, product availability function is not available. Refer to table below for the voltage out of range.

Rated voltage of RTSE	Voltage out of range
380–440 V	$\leq 263$ V or $\geq 534$ V
208–240 V	$\leq 163$ V or $\geq 291$ V

### NOTE:

- Alarm indicator is on (red LED) when there is a transfer failure or internal failure. When it is on, document this alarm and reach out field service. Then reset RTSE through dielectric switch, and alarm indicator will go off.
- Run status indicator is on when either source is in range and transfer switch equipment is not in manual mode.

## Terminals

For product availability: 1 NO + 1 NC:

- NO: P1-P0
- NC: P2-P0

When either source is in range and product is not in manual mode, NC terminal will open, and NO terminal will close.

## Signal type

- Digital output with dry contact
- 5 A/250 VAC. 5 A/30 VDC

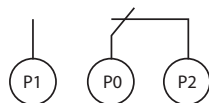

## Cable Capacity for Terminals

The cable capacity for the terminals are 0.5 – 2.5 mm<sup>2</sup> (AWG 24 ~ 12).

Maximum cable length: 10 m

## Remote Transfer

The remote transfer is a fixed function for TransferPacT Remote with following functions:

- Remote transfer is an active input. It can transfer the TSE to source I or source II or OFF position according to input signals. There's no time delay, no source detection for remote transfer.
- Customer should give a rising edge signal, and keep the signal for no less than 200 ms to start remote transfer.

## Electrical wiring

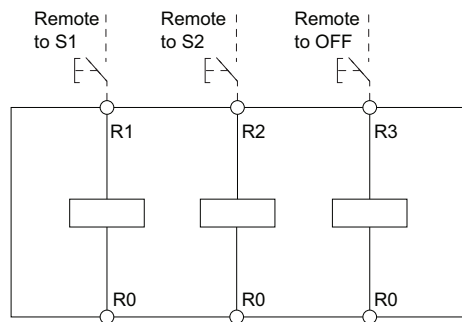

## Terminals

There are 4 terminals of the remote transfer function as below:

- R0-R1: Remote to SI
- R0-R2: Remote to SII
- R0-R3: Remote to OFF

## Signal type

- Digital input with dry contact.
- Need over 200 ms input to start remote control.

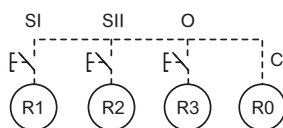

## Cable Capacity for Terminals

The cable capacity for the terminals are 0.5 – 2.5 mm<sup>2</sup> (AWG 24 ~ 12).

Maximum cable length: 10 m

# Wiring

## What's in This Chapter

Wiring Precautions .....	59
Wiring of Function Modules .....	60
Wiring of Auxiliary Contacts.....	66
Wiring Diagrams for Frame 100: 32–100 A .....	69
Wiring Diagrams for Frame 160: 80–160 A .....	71
Wiring Diagrams for Frame 250: 100–250 A, Frame 630: 320–630 A and Frame 800: 800 A.....	72
Wiring Diagrams for Frame 1600: 800–1600 A .....	73

## Wiring Precautions

Read and understand the following precautions before performing any procedures in this guide.

### **⚡⚠ DANGER**

#### **HAZARD OF ELECTRIC SHOCK, EXPLOSION, OR ARC FLASH**

- Apply appropriate personal protective equipment (PPE) and follow safe electrical work practices. See NFPA 70E, CSA Z462, NOM 029-STPS or local equivalent.
- This equipment must only be installed and serviced by qualified electrical personnel.
- Turn off all power supplying this equipment before working on this equipment.
- Use only the specified voltage when operating this equipment and any associated products.
- Power line circuits must be wired and protected in compliance with local and national regulatory requirements.
- Beware of potential hazards, and carefully inspect the work area for tools and objects that may have been left inside the equipment.

**Failure to follow these instructions will result in death or serious injury.**

### **⚠ WARNING**

#### **FIRE HAZARD**

- Use only the specified wiring gauge range with the equipment and comply with the specified wire termination requirements.
- Tighten the power line connections to the specified torque values.

**Failure to follow these instructions can result in death, serious injury, or equipment damage.**

### **⚠ WARNING**

#### **UNINTENDED EQUIPMENT OPERATION**

Always route communication wiring and power wiring separately.

**Failure to follow these instructions can result in death, serious injury, or equipment damage.**

## Wiring of Function Modules

This section describes the function modules wiring accessories of the TransferPacT Active Automatic / Automatic transfer switching equipment.

### TPCDIO05 : Load Shedding and Availability Warning

#### Wiring Diagram

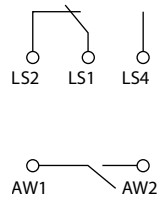

#### Terminal

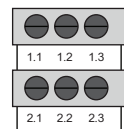

### TPCDIO07 : Transfer Inhibit with Remote Testing

#### Wiring Diagram

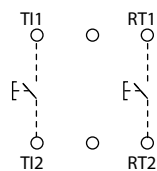

#### Terminal

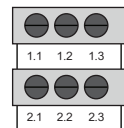

## TPCDIO08: Voluntary Remote Control

### Wiring Diagram

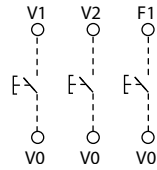

### Terminal

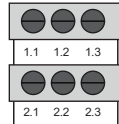

## TPCDIO10 : Fire Protection 24 V DC Pulse Input

### Wiring Diagram

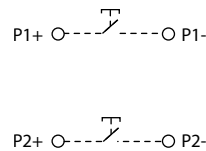

### Terminal

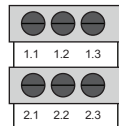

## TPCDIO11 : Fire Protection 24 V DC Constant Input

### Wiring

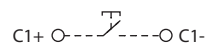

### Terminal

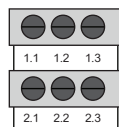

## TPCDIO13: Fire Protection 230 V AC Constant Input

### Wiring

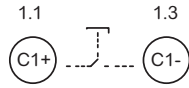

### Terminal

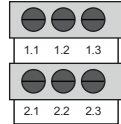

## TPCDIO14 : Fire Protection 1 Dry Contact Input

### Wiring

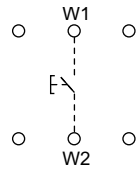

### Terminal

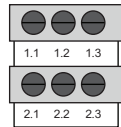

# TPCDIO15: BUS Extension and 24 V DC Auxiliary Supply

## Wiring

24V+      24V-  
 ○   +/-   ○

## Terminal

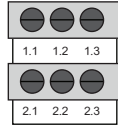

### NOTE:

- TPCDIO15 is used only for TransferPacT Active Automatic.
- To get the best performance, TPCDIO15 need to install on the rightmost slot of frame 100, 160 and 1A, and on the top slot of frame 250, 630 and 800.

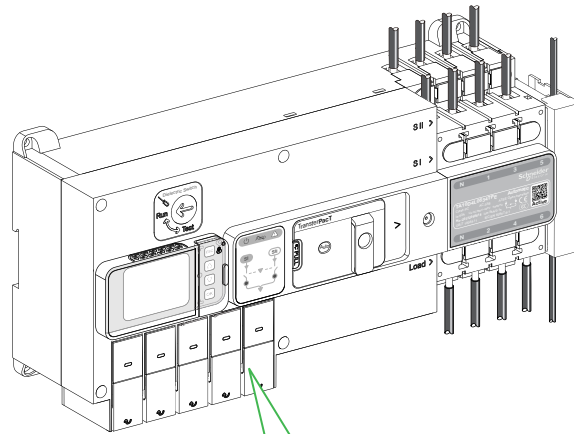

## TPCCOM16 : ModBus (RTU)

### Wiring

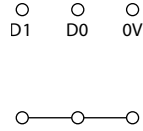

### Terminal

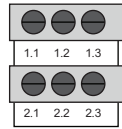

**NOTE:** TPCCOM16 is used only for TransferPacT Active Automatic.

## TPCDIO17 : Genset Start and Alarm

### Wiring

#### Version 1

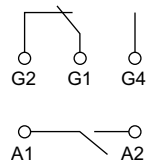

#### Version 2

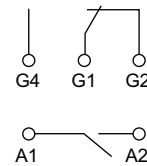

**NOTE:** The G2 and G4 terminals are swapped on two versions. Please inspect the label on the rotary cover to locate the positions.

### Terminal

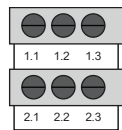

## TPCDIO19 : Source Indication

### Wiring

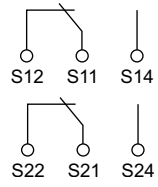

### Terminal

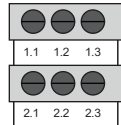

## Wiring of Auxiliary Contacts

For information on installation of auxiliary contacts, consult the instruction sheets on Schneider Electric website:

- TransferPacT Active Automatic / Automatic 32-100 A: JYT3049801
- TransferPacT Active Automatic / Automatic 80-160 A: JYT3049901
- TransferPacT Active Automatic / Automatic / Remote 100–250 A: GEX2525501
- TransferPacT Active Automatic / Automatic / Remote 320–630 A: GEX2525601
- TransferPacT Active Automatic / Automatic / Remote 800 A: BQT1751501
- TransferPacT Active Automatic 800–1600 A: BQT7680301

## Wiring Diagram for Source Position Auxiliary Contacts

### TPSAUX32/ TPSAUX43/ TPSAUX71 (Installed on left side)

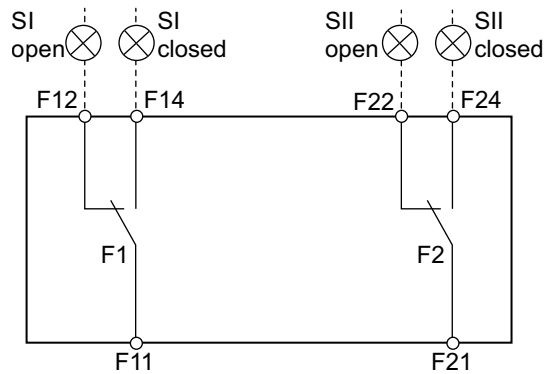

ATSE is closed at SI:

- F11-F14 is closed
- F11-F12 is opened

ATSE is closed at SII:

- F21-F24 is closed
- F21-F22 is opened

ATSE is at OFF position:

- F11-F12 and F21-F22 are closed
- F11-F14 and F21-F24 are opened

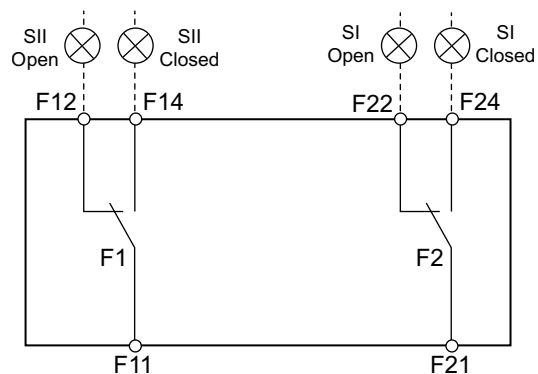
**TPSAUX71 (Installed on right side)**

ATSE is closed at SI:

- F21-F24 is closed
- F21-F22 is opened

ATSE is closed at SII:

- F11-F14 is closed
- F11-F12 is opened

ATSE is at OFF position:

- F21-F22 and F11-F12 are closed
- F21-F24 and F11-F14 are opened

## Wiring Diagram for OFF Position Auxiliary Contacts

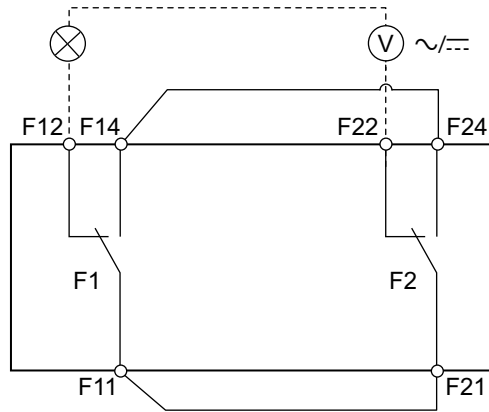

ATSE is at OFF position: F12-F22 is closed.

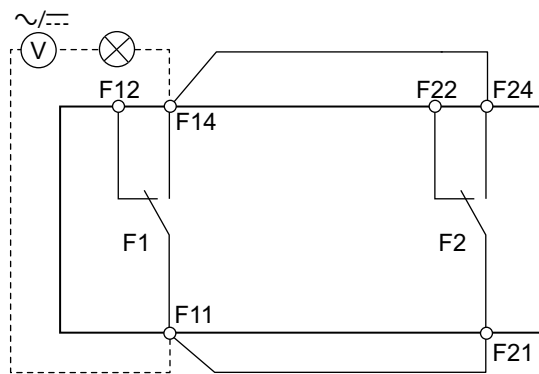

ATSE is not at OFF position: F11-F14 and F21-F24 are closed.

# Wiring Diagrams for Frame 100: 32–100 A

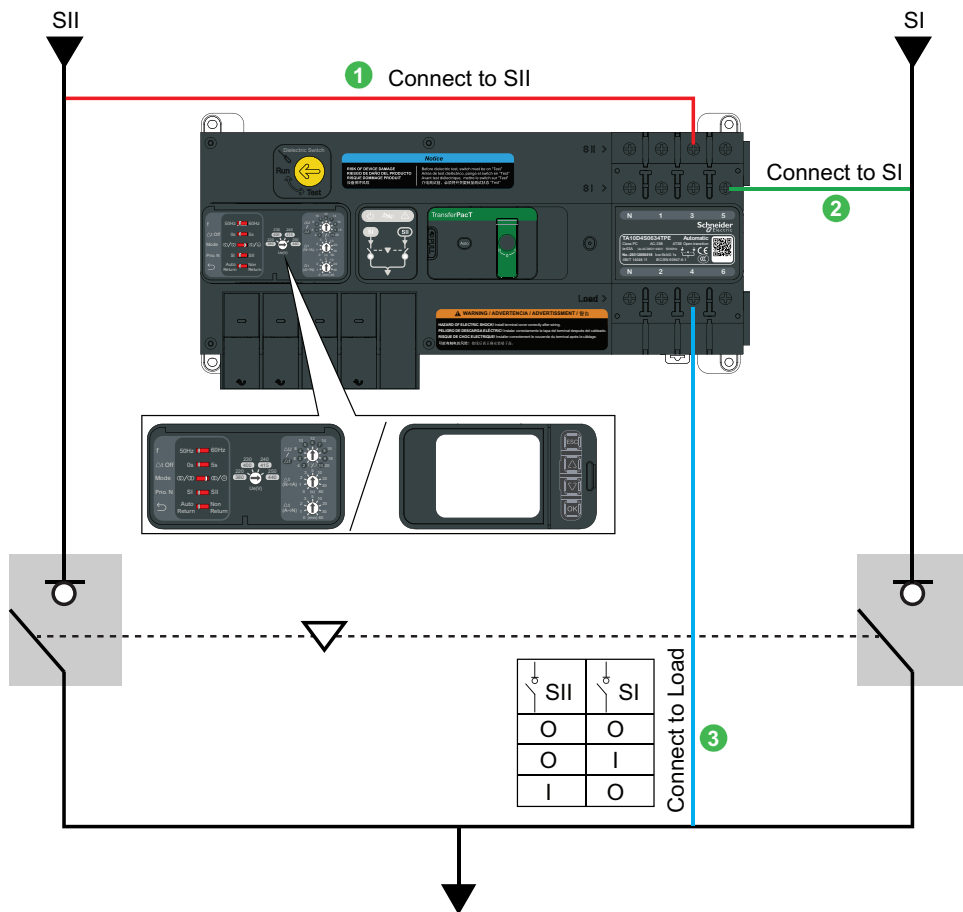

3P/4P

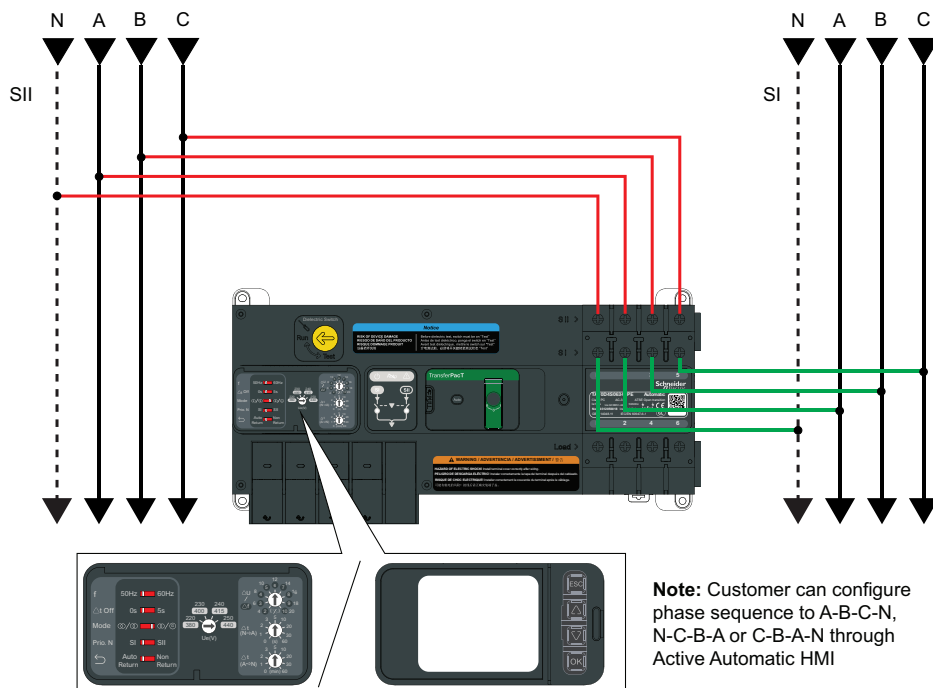

2P

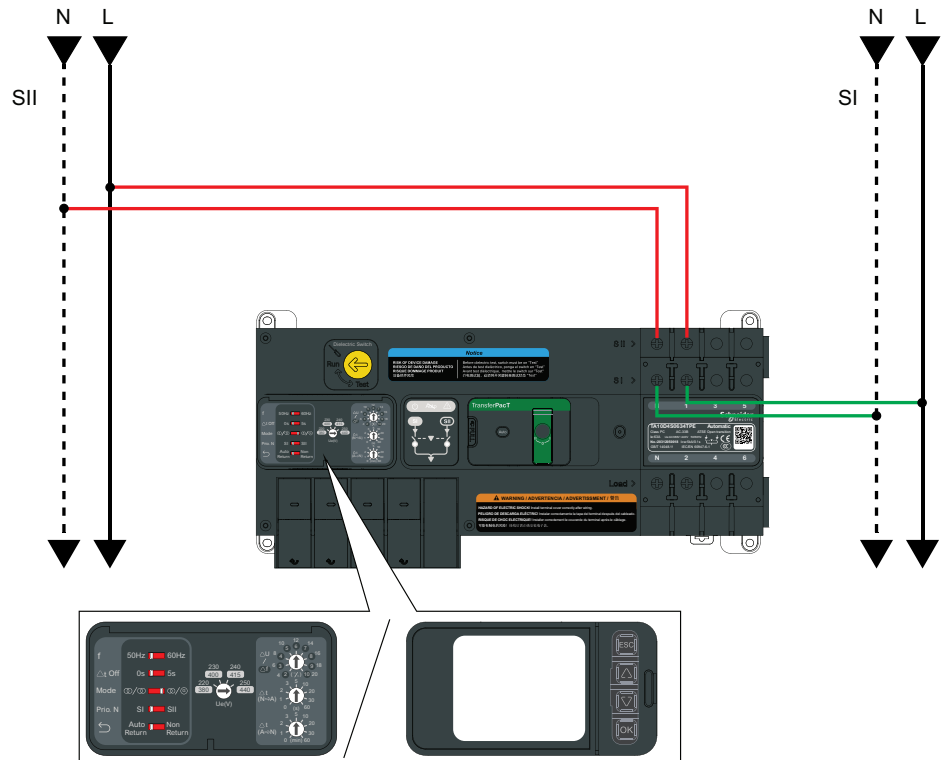

# Wiring Diagrams for Frame 160: 80–160 A

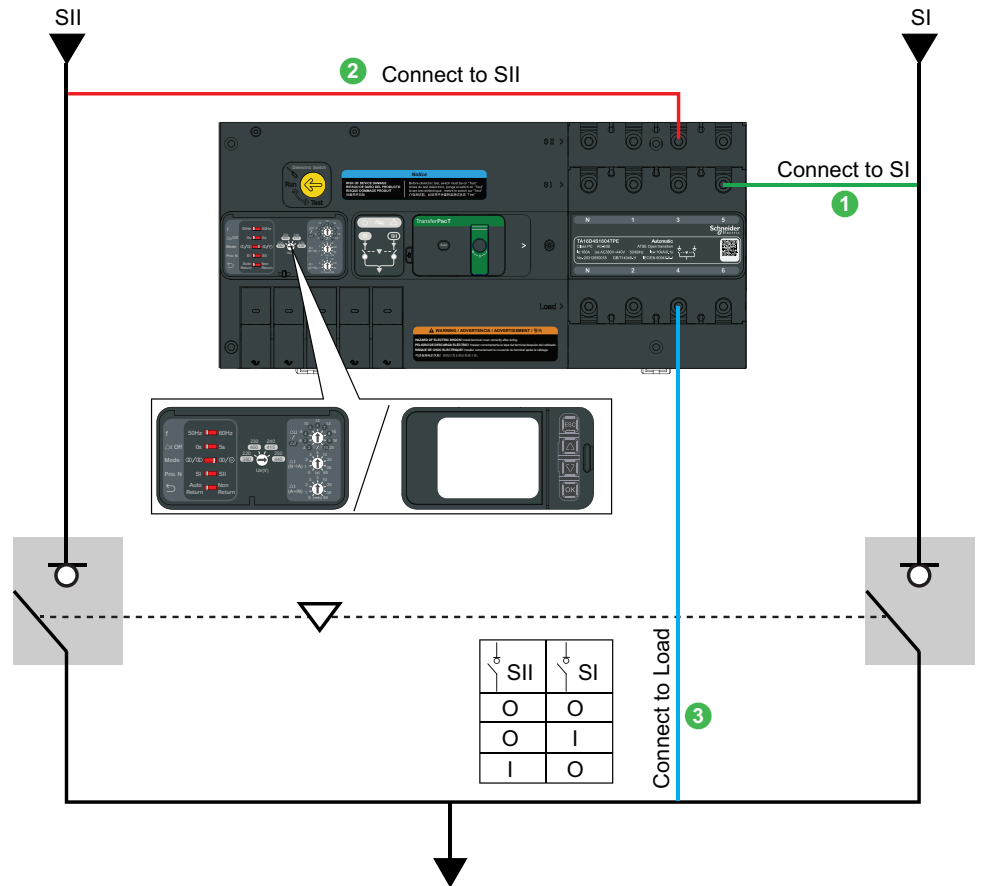

3P/4P

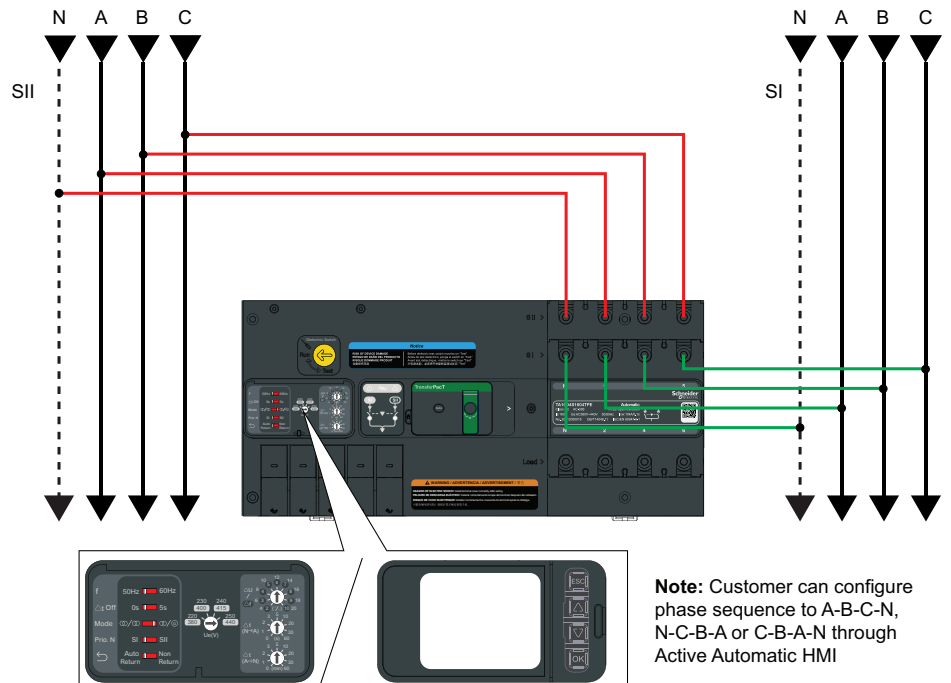

# Wiring Diagrams for Frame 250: 100–250 A, Frame 630: 320–630 A and Frame 800: 800 A

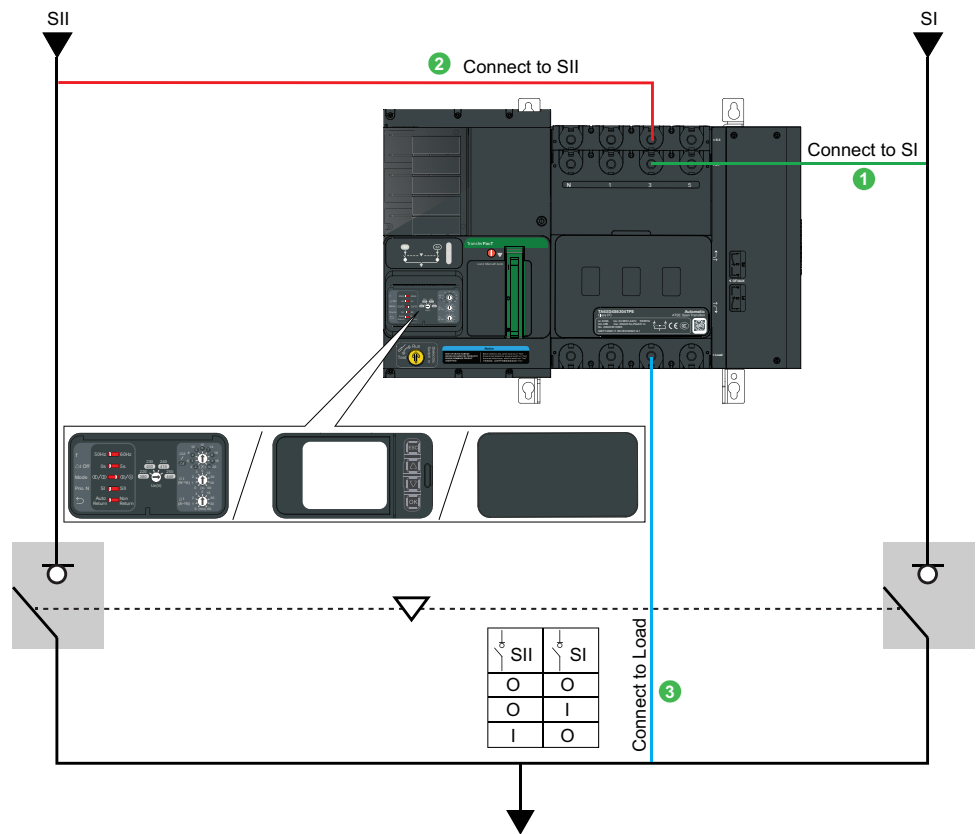

3P/4P

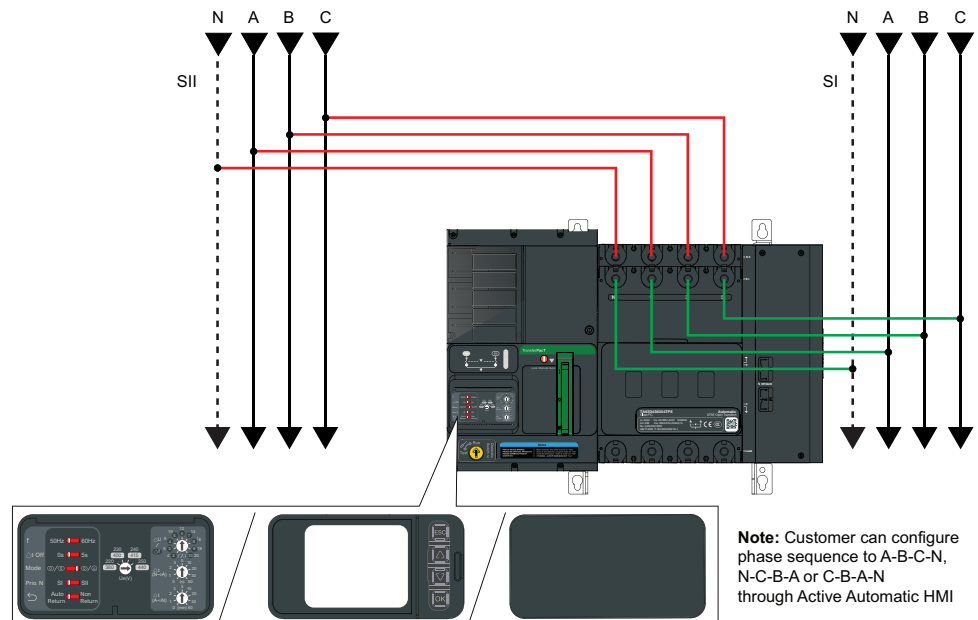

# Wiring Diagrams for Frame 1600: 800–1600 A

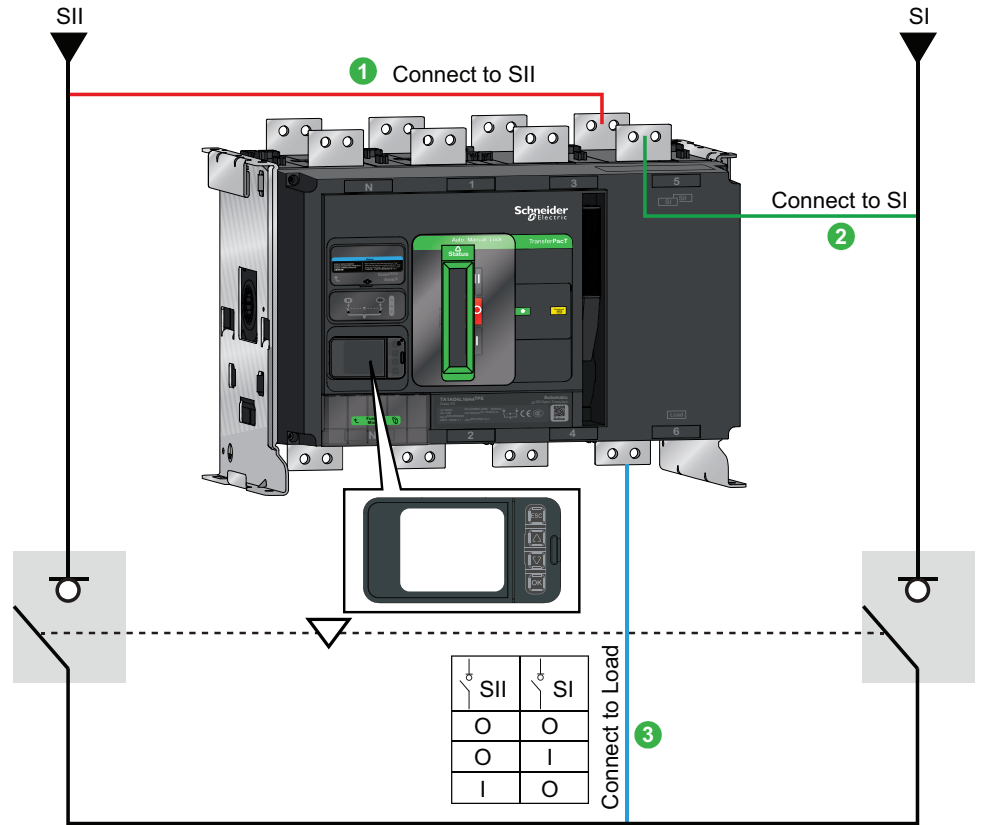

3P/4P

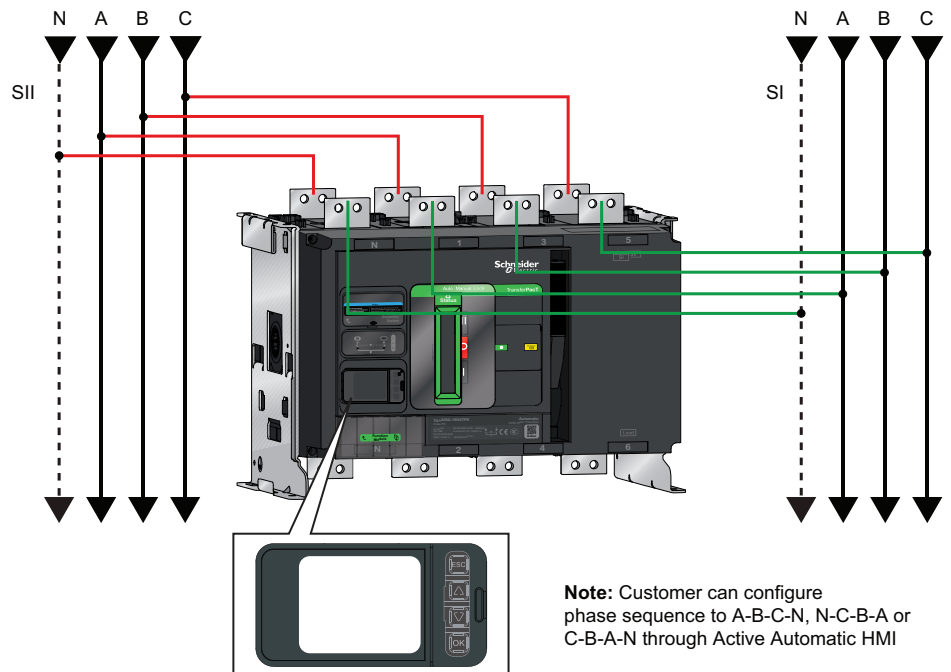

# Mechanism Accessories

## What's in This Chapter

Overview .....	75
Power Connection Accessories .....	76
Insulation Accessories .....	86
Auxiliary Contact .....	91
Upside-down Installation Kit .....	92
Insulation Rules .....	93

## Overview

The mechanism accessories for the TransferPacT Active Automatic, TransferPacT Automatic and TransferPacT Remote are as below:

- Power connection accessories
  - Steel connectors
  - Aluminum connectors
  - Linergy DP distribution block
  - Vertical connection adapters
  - Terminal extensions
  - Spreaders
  - Load extension bars
  - Cable lug adapters
  - Copper/aluminum lugs
- Insulation accessories
  - Terminal cover
  - Interphase barriers
  - Terminal shields
  - Insulating screens
  - PowerTag
- Auxiliary contacts
- Upside down installation kit
- Spare parts
  - Handles

## Power Connection Accessories

### ⚠ DANGER

#### HAZARD OF ELECTRIC SHOCK, EXPLOSION OR ARC FLASH

Ensure to prepare cables with correct stripping length specified in this section.

**Failure to follow these instructions will result in death or serious injury.**

### ⚠ WARNING

#### HAZARD OF FIRE

- Use only specified wiring cross-section with the equipment and comply with the specified wiring requirements.
- Tighten the connections to the specified torque values.

**Failure to follow these instructions can result in death, serious injury, or equipment damage.**

The power connectivity of the transfer switch can be improved by using power connection accessories. For the accessories connection of TransferPacT Active Automatic / Automatic / Remote 100– 250, 320– 630, and 800 A transfer switching equipment, refer to table in *Insulation Rules*, page 93.

## Steel Connector

### ⚠ CAUTION

#### HAZARD OF OVERHEATING

Do not use steel connectors LV429242 or LV429243 over 160 A.

**Failure to follow these instructions can result in injury or equipment damage.**

Steel connectors can be used to connect the switch and power cables.

They can be mounted on the TransferPacT Active Automatic / Automatic / Remote 100-250 A transfer switching equipment.

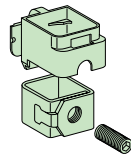

The table below provides the list of steel connectors.

Switch	Number of poles	Steel connectors
Frame 250: 100–250 A	3P	LV429242
	4P	LV429243

For information on installation, consult the instruction sheet on Schneider Electric website: GEX2525501.

## Aluminum Connector

**⚠ DANGER**

**HAZARD OF ELECTRIC SHOCK, EXPLOSION OR ARC FLASH**

It is mandatory to install terminal shield when the connectors are used.

**Failure to follow these instructions will result in death or serious injury.**

Aluminum connectors can be used to connect the switch and power cables. It supports to connect up to six cables simultaneously.

Aluminum connectors are screwed on the switch using the screws delivered with the aluminum connectors.

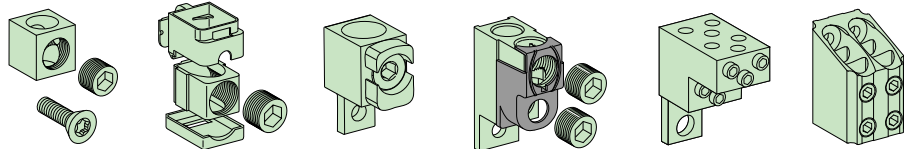

The table below provides the list of aluminum connectors.

Switch	Number of poles	Aluminum connector	Number of cables
Frame 250: 100–250 A	3P	LV429227	1
		LV429259	1
		TPSCON49 <sup>(1)</sup>	1
		TPSCON51	2
		TPSCON47	6
	4P	LV429228	1
		LV429260	1
		TPSCON50	1
		TPSCON52 <sup>(1)</sup>	2
		TPSCON48	6
Frame 630: 320–630 A	3P	TPSCON53	1
	4P	TPSCON54	1
Frame 1600: 800–1250 A	3P	33640	4
	4P	33641	4

<sup>(1)</sup> Aluminum connectors for load terminals only.

The bare cable connector (commercial references: 33640 and 33641) is not compatible with the spreader, vertical connection adapter or cable-lug adapter on TransferPacT Active Automatic 800–1250 A transfer switching equipment.

For information on installation, consult the instruction sheets on Schneider Electric website:

- TransferPacT Active Automatic / Automatic / Remote 100–250 A: GEX2525501
- TransferPacT Active Automatic / Automatic / Remote 320–630 A: GEX2525601
- TransferPacT Active Automatic 800–1600 A: BQT7680301

## Linery DP Distribution Block

To install the Linery DP on the Transfer switching equipment, consult the instruction sheet 04696008.

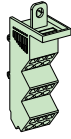

The table below provides the list of linery DP distribution block.

Switch	Number of poles	Linery DP distribution block
Frame 250: 100–250 A	3P	LVS04033
	4P	LVS04034

## Terminal Extension

### **⚠ DANGER**

#### **HAZARD OF ELECTRIC SHOCK, EXPLOSION OR ARC FLASH**

- It is mandatory to install interphase barriers when terminal extensions are used.
- For straight terminal extensions, it is mandatory to install insulating screen or custom made fiber insulating plate.

**Failure to follow these instructions will result in death or serious injury.**

The terminal extensions are used to extend the connection possibilities of the switch.

The terminal extensions are screwed on the switch using the screws delivered with the terminal extensions.

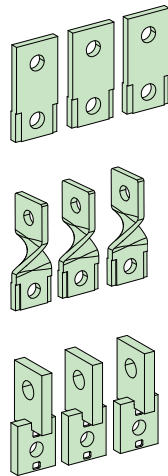

The table below provides the list of the straight terminal extension:

Switch	Number of poles	Straight terminal extensions
Frame 250: 100–250 A	3P	LV429263
	4P	LV429264

The table below provides the list of the edgewise terminal extension:

Switch	Number of poles	Edgewise terminal extensions
Frame 250: 100–250 A	3P	LV429308
	4P	LV429309
Frame 630: 320–630 A	3P	TPSCON55
	4P	TPSCON56

For information on installation, consult the instruction sheets on Schneider Electric website:

- TransferPacT Active Automatic / Automatic / Remote 100–250 A:  
GEX2525501
- TransferPacT Active Automatic / Automatic / Remote 320–630 A:  
GEX2525601

## Spreader

### ⚠ DANGER

#### HAZARD OF ELECTRIC SHOCK, EXPLOSION OR ARC FLASH

- It is mandatory to install interphase barriers when spreaders are used.
- It is mandatory to install insulating screen or custom made fiber insulating plate when spreaders are used.

**Failure to follow these instructions will result in death or serious injury.**

The spreaders are used on switches:

- to increase the pole pitch and align the poles with circuit breaker poles or
- to increase the clearance distance between phases or
- to connect larger bars or lugs.

The spreaders are screwed on the switch using the screws delivered with the spreaders.

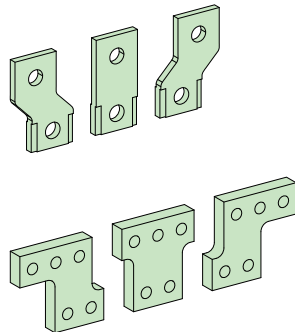

The table below provides the list of the spreader:

Switch	Number of poles	Spreader
Frame 250: 100–250 A	3P	LV431563
	4P	TPSCON39 <sup>(1)</sup>
	4P	LV431564 <sup>(2)</sup>
Frame 630: 320–630 A Frame 800: 800 A	3P	TPSCON40
	4P	TPSCON41 <sup>(1)</sup>
	4P	TPSCON68 <sup>(2)</sup>
Frame 1600: 800–1600 A	3P	33622 / LV833622SP <sup>(1)</sup>
	4P	33623 / LV833623SP <sup>(1)</sup>
(1) Spreaders for SI / SII power terminals only.		
(2) Spreaders for load terminals only.		

Spreaders are not compatible with the vertical connection adapter or cable-lug adapter on TransferPacT Active Automatic 800–1600 A transfer switching equipment.

For information on installation, consult the instruction sheets on Schneider Electric website:

- TransferPacT Active Automatic / Automatic / Remote 100–250 A: GEX2525501
- TransferPacT Active Automatic / Automatic / Remote 320–630 A: GEX2525601
- TransferPacT Active Automatic / Automatic / Remote 800 A: BQT1751501
- TransferPacT Active Automatic 800–1600 A: BQT7680301

## Load Extension Bar

Load extension bars are used to connect the power terminals of switch and cables for load side.

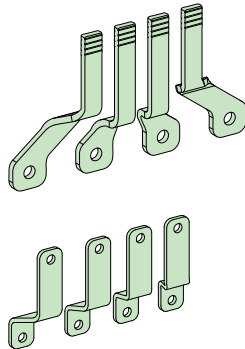

The table below provides the list of load extension bars:

Switch	Number of poles	Load extension bar
Frame 100: 32–100 A	4P	TPSCON35
Frame 160: 80–160 A	4P	TPSCON36

For information on installation, consult the instruction sheets on Schneider Electric website:

- TransferPacT Active Automatic / Automatic 32-100 A: JYT3049801
- TransferPacT Active Automatic / Automatic 80-160 A: JYT3049901

## Compression Lug

### ⚠ DANGER

#### HAZARD OF ELECTRIC SHOCK, EXPLOSION OR ARC FLASH

- It is mandatory to install interphase barrier.
- It is mandatory to use the screws provided in the switch packaging box.
- For aluminum lugs with interphase barriers, it is mandatory to install front insulating screen or custom made fiber insulating plate.
- For copper lugs two cable connection, it is mandatory to install rear insulating screen or custom made fiber insulating plate.

**Failure to follow these instructions will result in death or serious injury.**

### ⚠ WARNING

#### HAZARD OF FIRE

- Use only specified wiring cross-section with the equipment and comply with the specified wiring requirements.
- Tighten the connections with the specified torque value.

**Failure to follow these instructions can result in death, serious injury, or equipment damage.**

The compression lugs are screwed on the switch using the screws delivered with the switch.

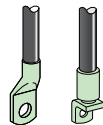

The table below provides the list of the compression lugs:

Switch	Number of poles	Material	Compression lug
Frame 250 : 100–250 A	3P	Cu	LV429252
			LV429253
			LV429254
		Al	LV429504
		LV429506	
	4P	Cu	LV429256
			LV429257
			LV429258
Al		LV429505	
	LV429507		
Frame 630: 320–630 A	3P	Cu	TPSCON57
			TPSCON59
		Al	TPSCON61
			TPSCON63
	4P	Cu	TPSCON58
			TPSCON60
		Al	TPSCON62
			TPSCON64
Frame 800: 800 A	3P	Cu	TPSCON57
			TPSCON59

Switch	Number of poles	Material	Compression lug
	4P	Cu	TPSCON58
			TPSCON60

For information on installation, consult the instruction sheets on Schneider Electric website:

- TransferPacT Active Automatic / Automatic / Remote 100–250 A:  
GEX2525501
- TransferPacT Active Automatic / Automatic / Remote 320–630 A:  
GEX2525601
- TransferPacT Active Automatic / Automatic / Remote 800 A: BQT1751501

## Vertical Connection Adapter

Vertical connection adapters are used to adapt the busbar connection of the TransferPacT Active Automatic 800–1600 A transfer switching equipment.

To adapt the cable lug connection on vertical connection adapters, connect the cable-lug adapter on the vertical connection adapter, and then connect the cable lug on the cable-lug adapter. For more information, refer to the [Cable-lug Adapter](#), page 85.

Vertical connection adapters are screwed on the switch using the screws delivered with the adapter.

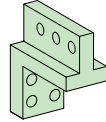

The table below provides the list of the vertical connection adapter:

Switch	Number of poles	Vertical connection adapters
Frame 1600: 800–1600 A	3P	33642 / LV833642SP
	4P	33643 / LV833643SP

For information on installation, consult the instruction sheet on Schneider Electric website: [BQT7680301](#) .

## Cable-lug Adapter

Cable-lug adapters are used to adapt the cable lug connection on vertical connection adapters of the TransferPacT Active Automatic 800–1600 A Transfer switching equipment.

Cable-lug adapters are screwed on the switch using the screws delivered with the cable-lug adapters.

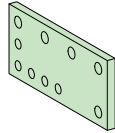

The table below provides the list of the vertical connection adapter:

Switch	Number of poles	Vertical connection adapter
Frame 1600: 800–1600 A	3P	33644 / LV833644SP
	4P	33645 / LV833645SP

For information on installation, consult the instruction sheet on the Schneider Electric website: [BQT7680301](#) .

## Insulation Accessories

### Terminal Cover

#### **⚠ DANGER**

##### **HAZARD OF FLASH OVER BETWEEN POLARITIES**

Terminal cover must be installed after wiring to ensure proper insulation.

**Failure to follow these instructions will result in death or serious injury.**

#### **⚠ WARNING**

##### **UNGUARDED MACHINERY HAZARD**

Install the terminal cover correctly after wiring, to ensure the insulation distance.

**Failure to follow these instructions will result in death or serious injury.**

Terminal covers are used between the power terminals to provide insulation between phases. They are supported on TransferPacT Active Automatic / Automatic 32-100 A and 80-160 A transfer switching equipment only.

For information on installation, consult the instruction sheets on Schneider Electric website:

- TransferPacT Active Automatic / Automatic 32-100 A: JYT3049801
- TransferPacT Active Automatic / Automatic 80-160 A: JYT3049901

## Interphase Barrier

Interphase barriers are installed between the power terminals of the transfer switching equipment to provide insulation between phases.

**NOTE:** The interphase barrier can not be used for TransferPacT Active Automatic / Automatic 32–100 A transfer switching equipment.

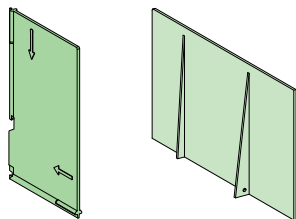

The table below provides the list of the interphase barrier:

Switch	Number of poles	Interphase barrier
Frame 160: 80–160 A	3P / 4P	TPSISO29
Frame 250: 100–250 A	3P / 4P	TPSISO65
Frame 630: 320–630 A Frame 800: 800 A	3P / 4P	TPSISO65
Frame 1600: 800–1600 A	3P / 4P	TPSISO70

For information on installation, consult the instruction sheets on Schneider Electric website:

- TransferPacT Active Automatic / Automatic 80-160 A: JYT3049901
- TransferPacT Active Automatic / Automatic / Remote 100–250 A: GEX2525501
- TransferPacT Active Automatic / Automatic / Remote 320–630 A: GEX2525601
- TransferPacT Active Automatic / Automatic / Remote 800 A: BQT1751501
- TransferPacT Active Automatic 800–1600 A: BQT7680301

## Terminal Shield

Terminal shields can be installed on the top and/or bottom of the power terminals of transfer switching equipment to provide IP20 protection.

**NOTE:** The terminal cover and the terminal shield cannot be used together.

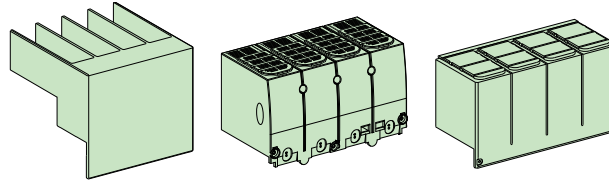

The table below provides the list of the terminal shield:

Switch	Number of poles	Terminal shield
Frame 100: 32–100 A	4P	TPSISO30
Frame 160: 80–160 A	4P	TPSISO31
Frame 250: 100–250 A	4P	LV429518
Frame 630: 320–630 A	4P	TPSISO42
Frame 800: 800 A		

For information on installation, consult the instruction sheets on Schneider Electric website:

- TransferPacT Active Automatic / Automatic 32-100 A: JYT3049801
- TransferPacT Active Automatic / Automatic 80-160 A: JYT3049901
- TransferPacT Active Automatic / Automatic / Remote 100–250 A: GEX2525501
- TransferPacT Active Automatic / Automatic / Remote 320–630 A: GEX2525601
- TransferPacT Active Automatic / Automatic / Remote 800 A: BQT1751501

## Insulating Screen

**⚠ DANGER**

**HAZARD OF ELECTRIC SHOCK, EXPLOSION OR ARC FLASH**

- It is mandatory to install insulating screens or custom made fiber insulating plates when clearance distance of wiring is less than the minimum clearance distance.

**Failure to follow these instructions will result in death or serious injury.**

Insulating screens are installed at the front or rear of the power terminals of the transfer switching equipment to provide insulation between phases.

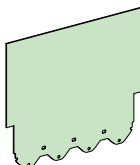

The table below provides the list of insulating screens:

Switch	Insulating screen
Frame 250: 100–250 A	TPSISO66
Frame 630: 320–630 A Frame 800: 800 A	TPSISO67

For information on installation, consult the instruction sheets on Schneider Electric website:

- TransferPacT Active Automatic / Automatic / Remote 100–250 A: GEX2525501
- TransferPacT Active Automatic / Automatic / Remote 320–630 A: GEX2525601
- TransferPacT Active Automatic / Automatic / Remote 800 A: BQT1751501

## PowerTag

The PowerTag can be mounted on the 4–pole TransferPacT Active Automatic / Automatic / Remote 100-250 A transfer switch equipment load side.

To install the PowerTag M250 on the Transfer switching equipment, consult the instruction sheet QGH46820.

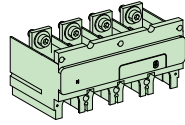

Switch	Number of poles	PowerTag
Frame 250: 100–250 A	4P	LV434021

## Auxiliary Contact

There are two categories of auxiliary contacts respectively for TransferPacT Active Automatic / Automatic transfer switching equipment.

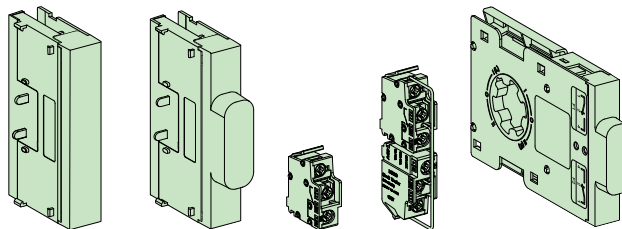

The table provides the list of auxiliary contacts:

Switch	Type of auxiliary contact	Auxiliary contact
Frame 100: 32–100 A	Source Position	TPSAUX32
	OFF Position	TPSAUX33
Frame 160: 80–160 A	Source Position	TPSAUX32
	OFF Position	TPSAUX33
Frame 250 100–250 A	Source Position	TPSAUX43
	OFF Position	TPSAUX44
Frame 630: 320–630 A	Source Position	TPSAUX43
Frame 800: 800 A	OFF Position	TPSAUX44
Frame 1600: 800–1600 A	Source Position	TPSAUX71
	OFF Position	TPSAUX72

For information on installation, consult the instruction sheets on Schneider Electric website:

- TransferPacT Active Automatic / Automatic 32-100 A: JYT3049801
- TransferPacT Active Automatic / Automatic 80-160 A: JYT3049901
- TransferPacT Active Automatic / Automatic / Remote 100–250 A: GEX2525501
- TransferPacT Active Automatic / Automatic / Remote 320–630 A: GEX2525601
- TransferPacT Active Automatic / Automatic / Remote 800 A: BQT1751501
- TransferPacT Active Automatic 800–1600 A: BQT7680301

## Upside-down Installation Kit

If necessary, the upside-down installation kit can be used to mount the transfer switching equipment in upside-down position for bottom power feeding.

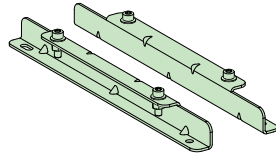

The below table provides the list of upside-down installation kit:



Switch	Vertical connection adapter
Frame 1600: 800–1600 A	TPSOTH73



For information on installation, consult the instruction sheet on the Schneider Electric website: [BQT7680301](http://BQT7680301).

# Insulation Rules

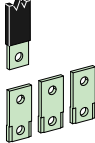
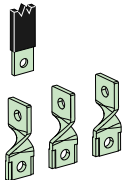
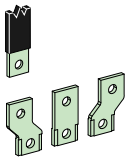
## Rules to Ensure Insulation for Frame 250: 100–250 A

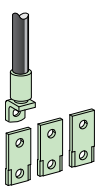
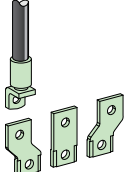

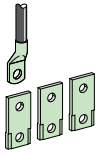
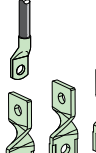
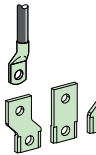
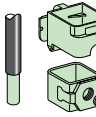
Refer to the following table for the insulation accessories to be installed when different types of conductors are installed on TransferPacT Active Automatic / Automatic / Remote 100–250 A transfer switching equipment.

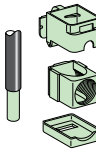
Type of conductor	No insulating accessory	Interphase barrier	Long terminal shield	Insulating screen for 1 lug per terminal	Insulating screen for 2 lugs per terminal
Insulated bars 	Possible	Possible	Possible	Possible	-
Insulated bars + straight terminal extensions 	-	Mandatory	-	Mandatory	-
Insulated bars + edgewise terminal extensions 	-	Mandatory	-	Possible	-
Insulated bars + spreaders 	-	Mandatory	-	Mandatory	-
Cables (Al) + crimp lugs 	-	Mandatory (Supplied)	Possible	-	-
Cables (Cu) + crimp lugs 	-	Mandatory (Supplied)	Possible	Possible	Mandatory
Cables (Al) + crimp lugs + straight terminal extensions 	-	Mandatory (Supplied)	-	Mandatory	-
Cables (Al) + crimp lugs + Spreaders 	-	Mandatory (Supplied)	-	Mandatory	-

Type of conductor	No insulating accessory	Interphase barrier	Long terminal shield	Insulating screen for 1 lug per terminal	Insulating screen for 2 lugs per terminal
Cables (Cu) + crimp lugs + straight terminal extensions 	-	Mandatory (Supplied)	-	Mandatory	NA / Mandatory (120 mm 2 only)
Cables (Cu) + crimp lugs + edgewise terminal extensions 	-	Mandatory (Supplied)	-	Possible	-
Cables (Cu) + crimp lugs + spreaders 	-	Mandatory (Supplied)	-	Mandatory	NA / Mandatory (120 mm 2 only)
Cables + steel connectors LV429242 LV429243 	Possible	Possible	Possible	-	-
Cables + aluminum connectors TPSCON47 TPSCON48 TPSCON49 TPSCON50 TPSCON51 TPSCON52 	-	-	Mandatory	-	-
Cables + aluminum connectors LV429227 LV429259 LV429228 LV429260 	Possible	Possible	Possible	-	-

## Rules to Ensure Insulation for Frame 630: 320–630 A

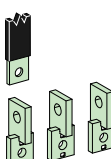
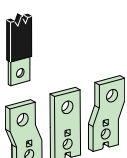

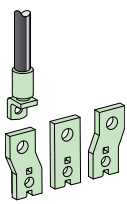
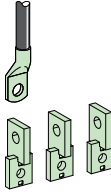
Refer to the following table for the insulation accessories to be installed when different types of conductors are installed on TransferPacT Active Automatic / Automatic / Remote 320–630 A transfer switching equipment.

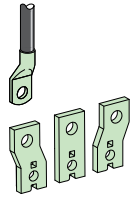
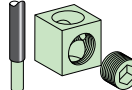
Type of conductor	No insulating accessory	Interphase barrier	Long terminal shield	Insulating screen for 1 lug per terminal	Insulating screen for 2 lugs per terminal
Insulated bars 	Possible	Possible	Possible	Possible	-
Insulated bars + edgewise terminal extensions 	-	Mandatory	-	Possible	-
Insulated bars + spreaders 	-	Mandatory	-	SI: front screen mandatory SII: rear screen mandatory Load: front screen mandatory	-
Cables (Al) + crimp lugs 	-	Mandatory (Supplied)	Possible (instead of phase barriers)	SI: front screen mandatory Load: front screen mandatory	-
Cables (Cu) + crimp lugs 	-	Mandatory (Supplied)	Possible (instead of phase barriers)	SII: rear screen possible	SII: rear screen mandatory
Cables (Al) + crimp lugs + spreaders 	-	Mandatory (Supplied)	-	SI: front screen mandatory SII: rear screen mandatory Load: front screen mandatory	-
Cables (Cu) + crimp lugs + edgewise terminal extensions 	-	Mandatory (Supplied)	-	Possible	-

Type of conductor	No insulating accessory	Interphase barrier	Long terminal shield	Insulating screen for 1 lug per terminal	Insulating screen for 2 lugs per terminal
Cables (Cu) + crimp lugs + spreaders 	-	Mandatory (Supplied)	-	SI: front screen mandatory  SII: rear screen mandatory  Load: front screen mandatory	SI: front screen mandatory  SII: rear screen mandatory  Load: front screen mandatory
Cables + aluminum connectors 	Possible	-	Mandatory	-	-

## Rules to Ensure Insulation for Frame 800: 800 A

Refer to the following table for the insulation accessories to be installed when different types of conductors are installed on TransferPacT Active Automatic / Automatic / Remote 800 A transfer switching equipment.

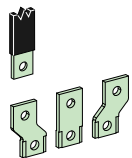
Type of conductor	No insulating accessory	Interphase barrier	Long terminal shield	Insulating screen for 1 lug per terminal	Insulating screen for 2 lugs per terminal
Cables (Cu) + crimp lugs 	-	Mandatory (Supplied)	-	SII: rear screen possible	SII: rear screen mandatory
Insulated bars 	Possible	Possible	Possible	Possible	-
Insulated bars + spreaders 	-	Mandatory (Supplied)	-	Mandatory	-

# HMI

## What's in This Chapter

Overview .....	98
Automatic HMI with Rotary Switch .....	99
Active Automatic HMI with LCD Display .....	101
External HMI .....	138

## Overview

TransferPacT ATSE has two embedded HMIs and one external HMI. The two embedded HMIs can be inserted on the slots of the embedded HMI. They are as below:

- Automatic HMI with rotary switch
- Active Automatic HMI with LCD display

The two embedded HMIs can be replaced with each other with hot swap approach.

# Automatic HMI with Rotary Switch

The Automatic HMI with rotary switch is convenient for commissioning.

## Automatic HMI Settings

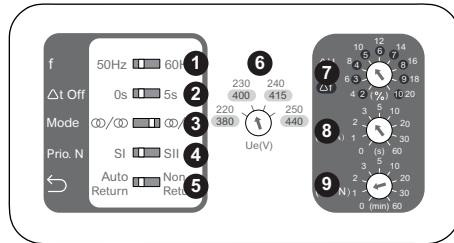

Label	Description	Function	Diagram
1	Dip switch for rated frequency	The rated frequency as nominal value will become the reference for frequency threshold.	50Hz <input type="checkbox"/> 60Hz
2	Dip switch for time delay at off position	<ul style="list-style-type: none"> <li>Time delay applied to the center-off position O when position I and position II are transferring, it stops at position O to protect inductive load.</li> <li>The delay is used for both process of transfer to N and A.</li> <li>The delay shall detect both sources, the stop condition will be either N recovered, or A source failed.</li> </ul>	0s <input type="checkbox"/> 5s
3	Dip switch for application	The application type can be selected as Utility to Utility or Utility to Genset.	<input type="checkbox"/> / <input type="checkbox"/> <input type="checkbox"/> / <input type="checkbox"/>
4	Preferable source selection or priority source, page 149	SI and SII indicate the physical position of source. The normal and alternate power can be match to SI or SII according to requirement: <ul style="list-style-type: none"> <li>When select SI as priority: SI becomes normal power while SII becomes alternate power.</li> <li>When select SII as priority: SII becomes normal power while SI becomes alternate power.</li> </ul>	SI <input type="checkbox"/> SII
5	Dip switch for working mode	Two auto working mode can be selected: <ul style="list-style-type: none"> <li>Auto-Auto return</li> <li>Auto-Non return</li> </ul>	Auto Return <input type="checkbox"/> Non Return
6	Rotary switch for rated voltage Ue	The rated voltage as nominal value will become the reference for voltage threshold. 2P (L-N) : 220 V, 230 V, 240 V, 250 V. 3P and 4P (L-L): 380 V, 400 V, 415 V, 440 V.	230 240 400 415 220 250 380 440 Ue(V)
7	Rotary switch for threshold selection of voltage and frequency	$\Delta f$ : The frequency deviation gap as reference of rated frequency. $\Delta U$ : The voltage deviation gap as reference of rated voltage.	$\Delta U$ / $\Delta f$ 10 12 14 8 5 6 7 16 4 3 8 9 18 6 3 10 20 4 2 (%)

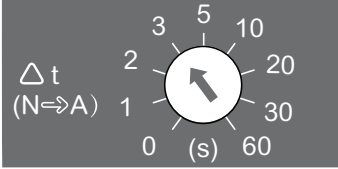
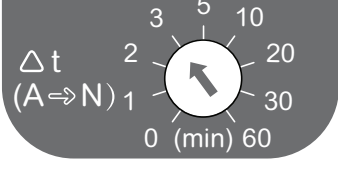
Label	Description	Function	Diagram
8	Rotary switch for transfer time delay from N–A	$\Delta t$ : Transfer time delay between N–A. The unit is second.	
9	Rotary switch for re-transfer time delay from A–N	$\Delta t$ : Transfer time delay between A–N. The unit is minute.	

## Active Automatic HMI with LCD Display

The Active Automatic HMI with LCD display of the switch matches to all extension accessories using TPCDIO15. It displays all logs and settings with password protection. It can also be extended with more advanced functions, such as communications with extension plus 24 V DC.

### Active Automatic HMI Settings

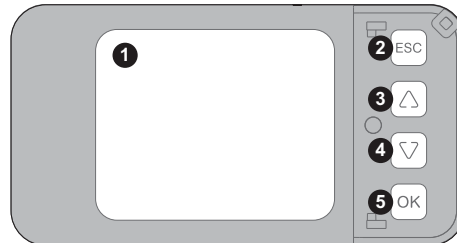

Label	Description	Function
1	LCD screen	LCD screen for display
2	ESC	ESC button to cancel the selected option or return to the previous menu
3	Up button	Up navigation button for rolling up
4	Down button	Down navigation button for rolling down
5	OK button	OK button to confirm the selected option

## Wizard Setup

**NOTE:** The transfer function of TransferPacT ATSE is available only after configuring wizard setup.

A Wizard should be configured once the ATSE is power ON for the first time.

Perform the following procedure to complete the wizard setup:

1. Select the language.

There are eight languages and options are:

- English
- French
- Spanish
- German
- Italian
- Portuguese
- Russian
- Chinese



2. Select the **Rated Voltage**.

The rated voltages options are:

- 2P: 220 V, 230 V, 240 V, 250 V
- 3P and 4P: 380 V, 400 V, 415 V, 440 V

**NOTE:** The power supply of TransferPacT is required to be 380 V AC - 20% to 440 V AC + 20% at a frequency of 50/60 Hz and it has been developed to meet most of the network configurations.

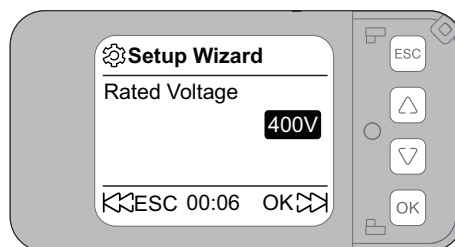

3. Select the **Rated Frequency**.

The rated frequencies options are:

- 50 Hz
- 60 Hz

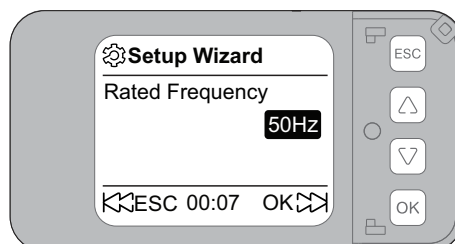

4. Select the **Neutral Position**.

The neutral position options are:

- N-A-B-C
- A-B-C-N
- N-C-B-A
- C-B-A-N

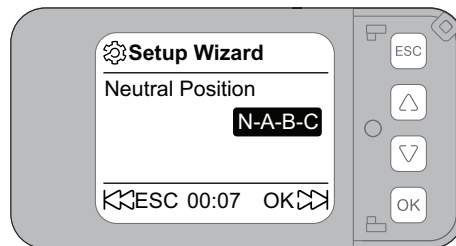

5. Select the **Source Configuration**.

The different source type and priority is shown below:

- SI-Utility(N)/SII-Utility(A)
- SI-Utility(N)/SII-Genset(A)
- SI-Genset(A)/SII-Utility(N)
- SI-Utility(A)/SII-Utility(N)

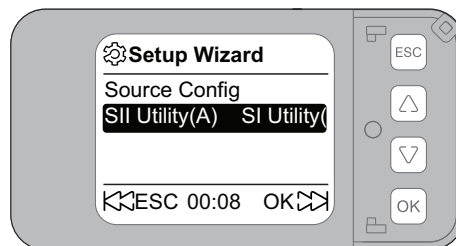

6. Select the **Return Modes**.

The return modes options are:

- Auto-Return
- Non-Return

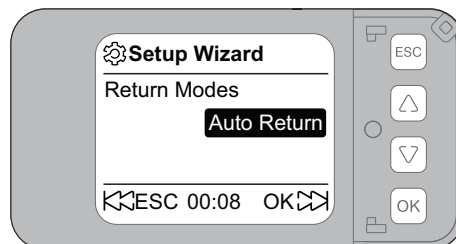



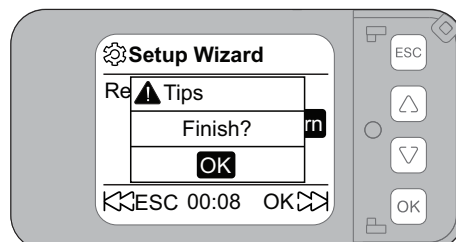



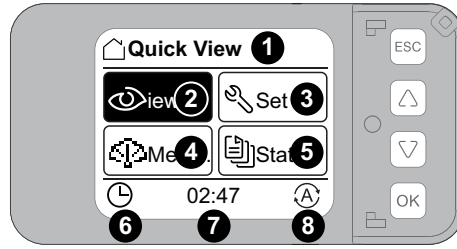

7. Click **OK** to save the changes.



## Home Page of LCD Display



Label	Description	Function
1	Quick View	Name for current page
2	Quick View	Open Quickview menu to check general information of ATSE
3	Set & operate	Open Set & operate menu for commissioning and settings
4	Measure	Open Measure menu to check the details of power status
5	Status	Open Status menu to check status of ATSE include event logs
6	Icon for time	To show the time
7	Time	Time which needs to be reset after power contingency
8	Transfer Mode	<p>Eight control modes:</p> <ul style="list-style-type: none"> <li>• Auto mode (AT) </li> <li>• Test mode </li> <li>• Comm mode </li> <li>• Voluntary transfer mode </li> <li>• Local control mode </li> <li>• Transfer Inhibit mode </li> <li>• Force to off mode </li> <li>• Fire protection mode </li> <li>• Handle transfer mode </li> </ul>

# Quickview Page

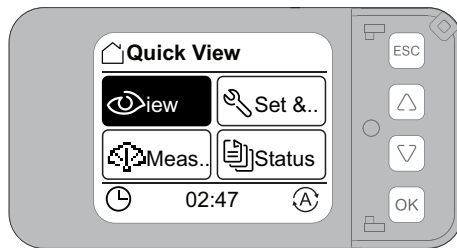

1. Select **Quick View** and press **OK** button to open its sub-pages.
2. Press Up and Down buttons to navigate to each sub-page.

The below table provide the details of the **Quick View** sub-pages:

Sub-page name	Sub-page function	Display
<b>System Overview</b>	To show the system overview: <ul style="list-style-type: none"> <li>• SI and SII general status.</li> <li>• Contact position.</li> </ul>	
<b>SI</b>	To show the SI voltage status: <ul style="list-style-type: none"> <li>• Real time phase voltage of SI.</li> <li>• Real time frequency of SI.</li> </ul>	
<b>SII</b>	To show the SII power status: <ul style="list-style-type: none"> <li>• Real time phase voltage of SII.</li> <li>• Real time frequency of SII.</li> </ul>	
<b>Slots</b>	To show the slot status: <ul style="list-style-type: none"> <li>• Black box indicates that the accessories are working.</li> <li>• Empty box indicates that the accessories are not working.</li> </ul>	
<b>Date / Time</b>	This sub page is to show the timer in controller. <b>NOTE:</b> Calibrate the timer after long terms of power interruption. Use DC 24 V to keep the accuracy of the timer.	

## Measurement Page

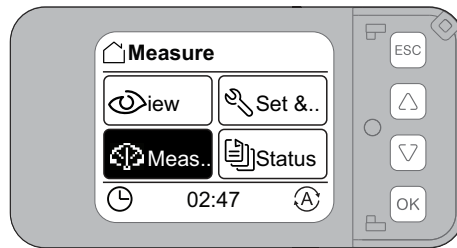

1. Select **Measurement** and press **OK** button to open its sub-pages.
2. Press Up and Down buttons to navigate to each sub-page.

The below table provide the details of the **Measurement** sub-pages:

Sub-page name	Sub-page function	Display
<b>Measure</b>	To show the rolling list of source: <ul style="list-style-type: none"> <li>• Use up and down button for navigation.</li> <li>• Click different source and voltage to check their voltage information.</li> </ul>	
<b>SI or SII Voltage</b>	To show the SI or SII voltage status: <ul style="list-style-type: none"> <li>• Real time phase voltage of SI or SII.</li> <li>• Real time frequency of SI or SII.</li> </ul>	
<b>SI Others</b>	To show the rolling list of source: <ul style="list-style-type: none"> <li>• Use up and down button for navigation.</li> <li>• Click different source and others to check their power information.</li> </ul>	
<b>SI or SII Others</b>	To show the SI or SII other status: <ul style="list-style-type: none"> <li>• Real time frequency of SI or SII.</li> <li>• Real time unbalance rate of SI or SII.</li> </ul>	

# Status Page

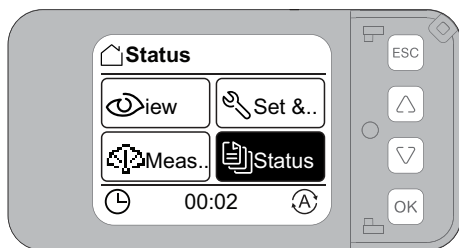

1. Select **Status** and press **OK** button to open its sub-pages.
2. Press Up and Down buttons to navigate to each sub-page.

The below table provide the details of the **Status** sub-pages:

Sub-page name	Sub-page function	Display
<b>Slots</b>	<b>Slots Status</b> sub-page navigates to more status checking in the display and click <b>Slots</b> to check status of accessories slots.	
	<p>To show the <b>Slot</b> status:</p> <ul style="list-style-type: none"> <li>• Black box indicates that the accessories has inserted well.</li> <li>• Empty box indicates that the accessories has not inserted or not inserted well.</li> </ul>	
<b>Transfer Diagnostic</b>	<b>Transfer Diag</b> sub-page navigates to more status checking in the display and click <b>Transfer Diag</b> to check the transfer times.	
	<p><b>Transfer Diag</b> sub-page is to show the transfer times:</p> <ul style="list-style-type: none"> <li>• Successful transfer counts</li> <li>• Failed transfer counts</li> <li>• Too many transfer counts</li> </ul>	
<b>Event Logs</b>	<b>Event Logs Status</b> sub-page navigates to more status checking in the display and click <b>Event Logs</b> to check list of logs.	

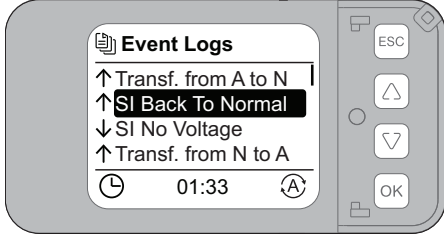
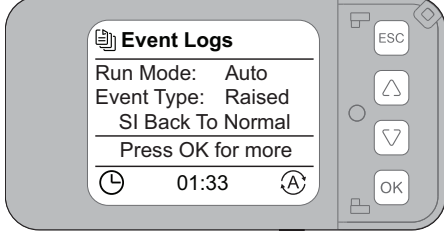
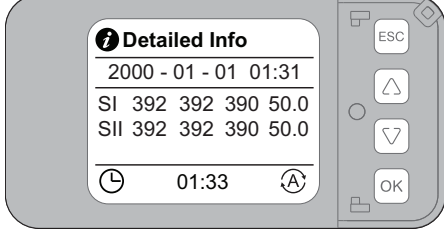
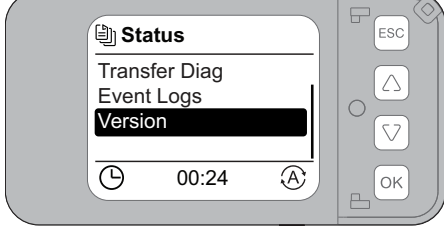
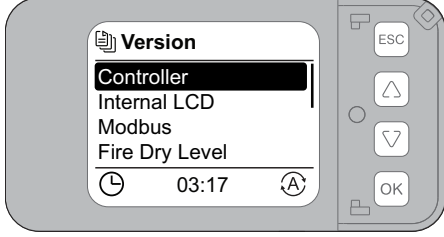
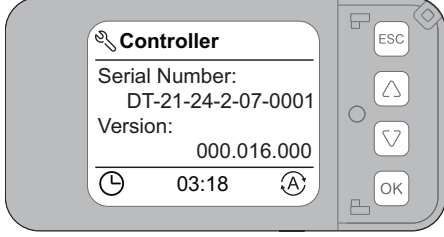
Sub-page name	Sub-page function	Display
	<p><b>Event Logs</b> sub-page is to show the list of event logs:</p> <ul style="list-style-type: none"> <li>• Use up and down button for navigation.</li> <li>• Click <b>Event Log XX</b> to check status of logs.</li> </ul>	
<p><b>Event Logs</b></p>	<p><b>Event Logs</b> sub-page is to show the information of event logs:</p> <ul style="list-style-type: none"> <li>• Time of events.</li> <li>• Source status during events.</li> </ul> <p>For more information on Event Code, refer to Event Logs., page 224</p>	
<p><b>Detailed Info</b></p>	<p>To show the cause of events:</p> <ul style="list-style-type: none"> <li>• Transfer mode during events.</li> <li>• Type of events.</li> </ul>	
<p><b>Version</b></p>	<p><b>Version Status</b> sub-page navigates to more status checking in the display and click <b>Version</b> to check product information.</p>	
	<p>To show the list of hardware components:</p> <ul style="list-style-type: none"> <li>• Use up and down button for navigation.</li> <li>• Click different components to check their information.</li> </ul>	
<p><b>Controller</b></p>	<p>To show the components information</p> <ul style="list-style-type: none"> <li>• Series number of components.</li> <li>• Firmware version.</li> </ul>	

## Set & Operate Page

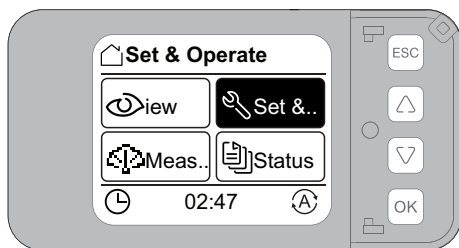

1. Select **Set & Operate** and press **OK** button to open its sub-pages.
2. Press Up and Down buttons to navigate to each sub-page.

## Operations Sub-Page

**NOTE:** Once the TransferPacT ATSE is power ON for the first time, suggested to change the password. The default password is 0000.

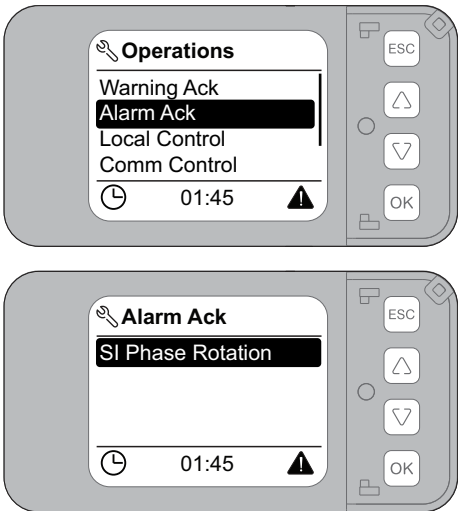
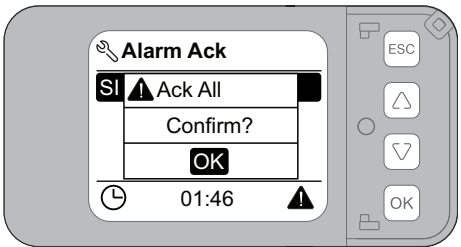
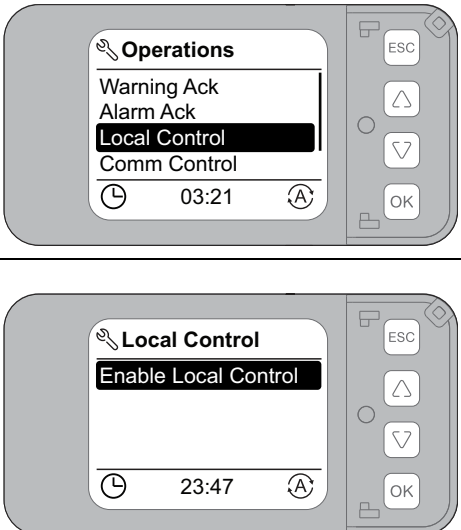
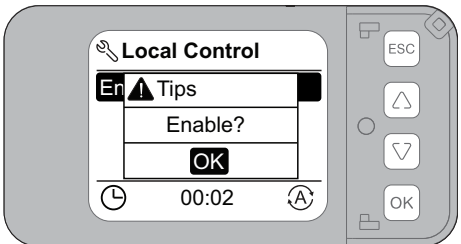

The below table provide the details of the **Operations** sub-pages:

Sub-page name	Sub-page function	Display
<b>Operations</b>	<b>Set &amp; Operate</b> page navigates to more maintenance checking in the display and click <b>Operations</b> to control the ATSE or acknowledge the alarm.	
<b>Warning Acknowledge</b>	Click <b>Warning Ack</b> to cancel the alarm.	 
<b>Confirm Operation</b>	<b>Confirm Operation</b> window is to confirm the <b>Warning Acknowledge</b> .	

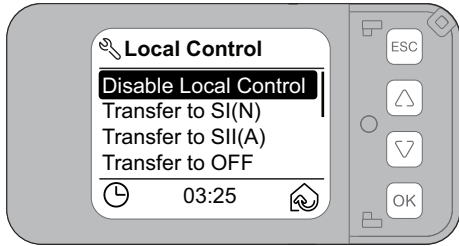
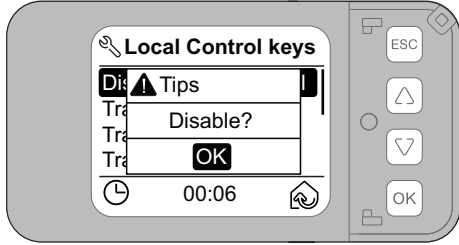
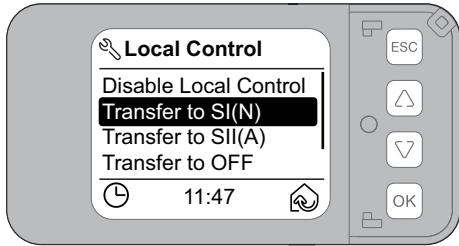
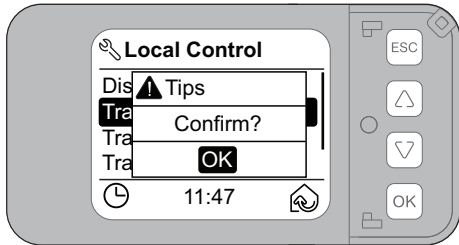
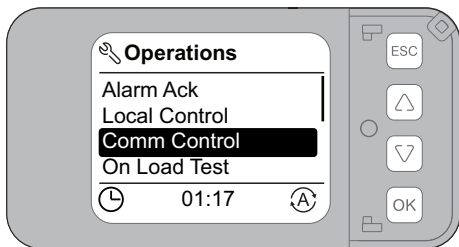
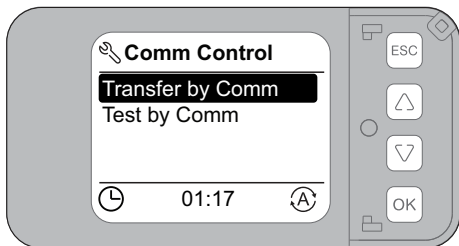
Sub-page name	Sub-page function	Display
<p><b>Alarm Acknowledge</b></p>	<p>Click <b>Alarm Ack</b> to cancel the alarm.</p>	
<p><b>Confirm Operation</b></p>	<p><b>Confirm Operation</b> window is to confirm the <b>Alarm Acknowledge</b>.</p>	
<p><b>Local Control</b></p>	<p>Click <b>Local Control</b> to enter local control mode.</p> <ul style="list-style-type: none"> <li>• When open the first page, the local control is disabled.</li> <li>• Click <b>Enable Local Control</b> to energize local control mode.</li> <li>• Local Control cannot be enabled under handle mode, force mode, and fire protection mode.</li> </ul>	
<p><b>Confirm Operation</b></p>	<p><b>Confirm Operation</b> window is to confirm the <b>Local Control</b>.</p>	

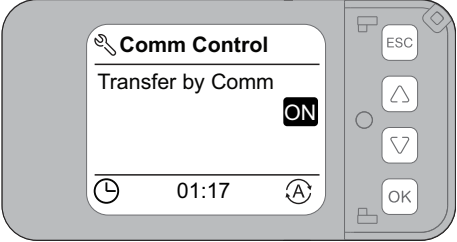
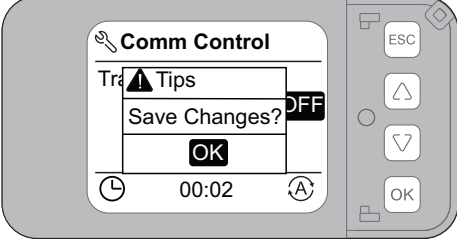
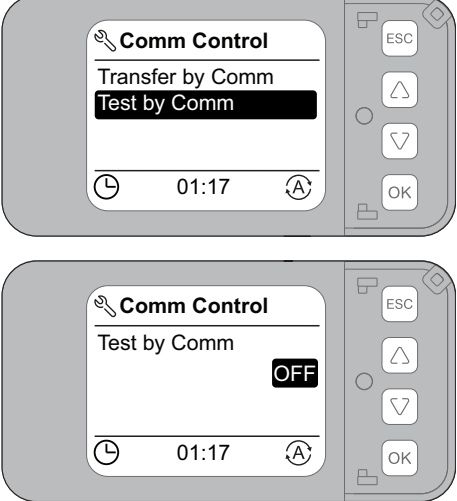
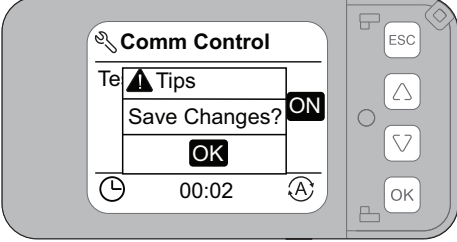
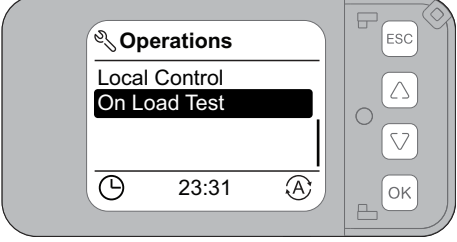
Sub-page name	Sub-page function	Display
<p><b>Disable Local Control</b></p>	<p><b>Disable Local Control</b> is a sub-page of <b>Local Control</b>.</p> <p>Select the <b>Disable Local Control</b> again to exit local control mode.</p> <p><b>NOTE:</b> If exit this page without disable local control mode, the transfer switch will stay at local control mode until a control mode with higher priority is coming</p> <p> at the bottom indicates the transfer mode.</p>	
<p><b>Confirm Operation</b></p>	<p><b>Confirm Operation</b> window is to confirm the <b>Local Control</b>.</p>	
<p><b>Transfer to SI(N)</b> <b>Transfer to SII(A)</b> <b>Transfer to OFF</b></p>	<p><b>Transfer to SI(N)</b> and <b>Transfer to SII(A)</b> depends on target source status, <b>Transfer to OFF</b> always active.</p> <p>After enabling the <b>Local Control</b>, there are three options:</p> <ul style="list-style-type: none"> <li>Click <b>Transfer to SI (N)</b> to transfer the switch to normal.</li> <li>Click <b>Transfer to SII (A)</b> to transfer the switch to alternative.</li> <li>Click <b>Transfer to OFF</b> to transfer the switch to OFF.</li> </ul> <p><b>NOTE:</b> Transfer to N or A will be successful only when the target source is present and in range.</p>	
<p><b>Confirm Operation</b></p>	<p><b>Confirm Operation</b> window is to confirm the <b>Local Control</b>.</p>	
<p><b>Comm Control</b></p>	<p>Click <b>Comm Control</b> to enter communication control mode.</p> <p><b>Comm control</b> navigates to more COM operation in the display.</p>	
<p><b>Transfer by Comm</b></p>	<p><b>Transfer by Comm</b> is a sub-page of <b>Comm Control</b>.</p> <p>Select <b>Transfer by Comm</b> to set the operation:</p> <ul style="list-style-type: none"> <li><b>ON:</b> enable transfer by com function.</li> <li><b>OFF:</b> disable transfer by com function.</li> </ul> <p><b>NOTE:</b> The function is disabled by default.</p>	

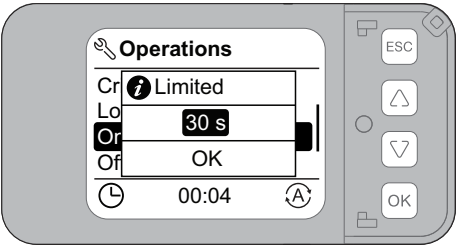
Sub-page name	Sub-page function	Display
		
<p><b>Confirm Operation</b></p>	<p><b>Confirm Operation</b> window is to confirm the <b>Transfer by Comm</b> and click <b>OK</b> to save changes.</p>	
<p><b>Test by Comm</b></p>	<p><b>Test by Comm</b> is a sub-page of <b>Comm Control</b>.</p> <p>Select <b>Test by Comm</b> to set the operation:</p> <ul style="list-style-type: none"> <li>• <b>ON</b>: enable test by com function.</li> <li>• <b>OFF</b>: disable test by com function.</li> </ul> <p><b>NOTE:</b> The function is disabled by default.</p>	
<p><b>Confirm Operation</b></p>	<p><b>Confirm Operation</b> window is to confirm the <b>Test by Comm</b> and click <b>OK</b> to save changes.</p>	
<p><b>On Load Test</b></p>	<p><b>Operations</b> sub-page navigates to more operating option in the display and click <b>On Load Test</b> to enter test mode.</p>	

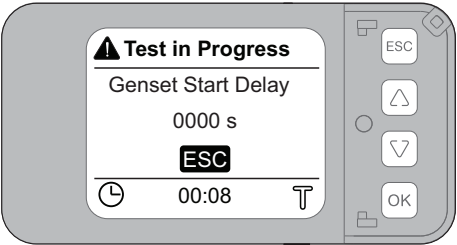
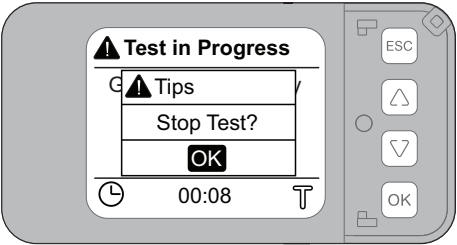
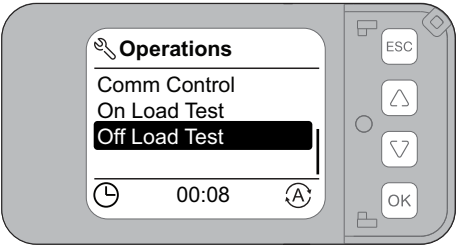
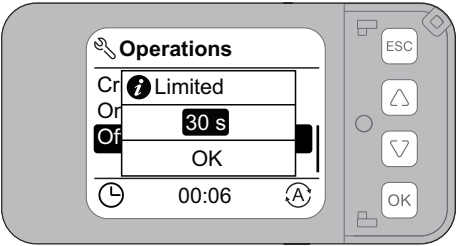
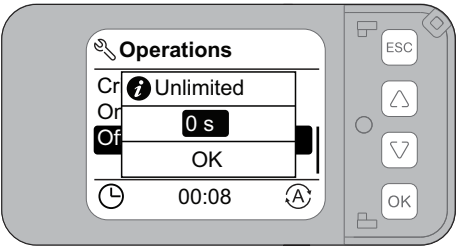
Sub-page name	Sub-page function	Display
Confirm Operation	Confirm Operation window is to confirm the On Load Test.	
Test in Progress	<p>The icon  indicates that the test is started. Test can be interrupted during the process.</p> <p><b>NOTE:</b> Select <b>ESC</b> and click <b>OK</b> to stop the test, ATSE will go back to Auto mode.</p>	
Confirm Operation	Confirm Operation window is to confirm the On Load Test.	
Off Load Test	Click <b>Off Load Test</b> to enter test mode.	
Confirm Operation	<p>Confirm Operation window is to confirm the Off Load Test.</p> <p>Confirm to select Limited test or Unlimited test</p>	 <p>limited test</p>
		 <p>unlimited test</p>

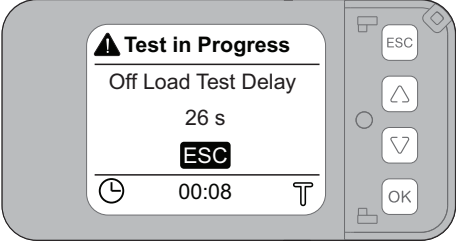
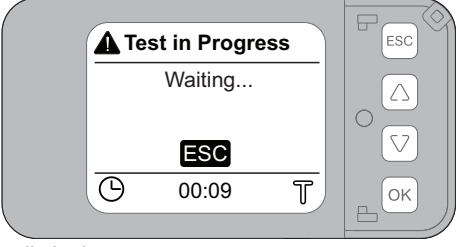
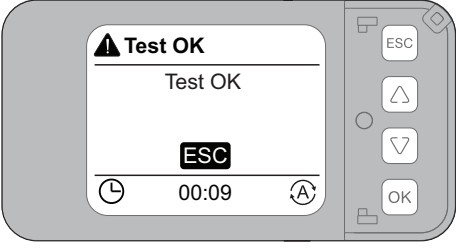
Sub-page name	Sub-page function	Display
<p><b>Test in Progress</b></p>	<p>The icon indicates that the test is started. Test can be interrupted during the process.</p> <p><b>NOTE:</b></p> <p>Select <b>ESC</b> and click <b>OK</b> to stop the test, ATSE will go back to Auto mode.</p>	 <p>limited test</p>
		 <p>unlimited test</p>
<p><b>Confirm Operation</b></p>	<p><b>Confirm Operation</b> window is to confirm the <b>Off Load Test</b>.</p>	 <p>unlimited test</p>

## System Parameters Sub-Page

The below table provide the details of the **System Parameters** sub-pages:

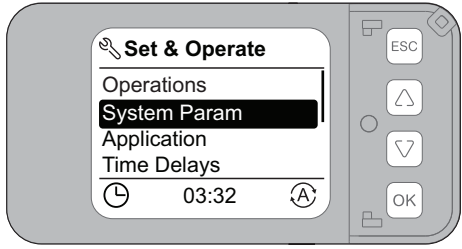
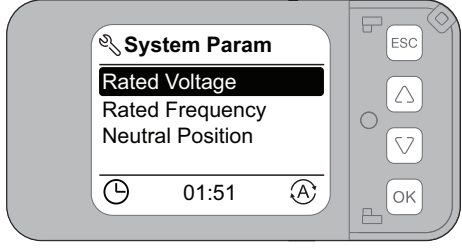
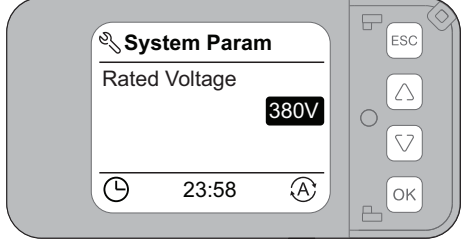
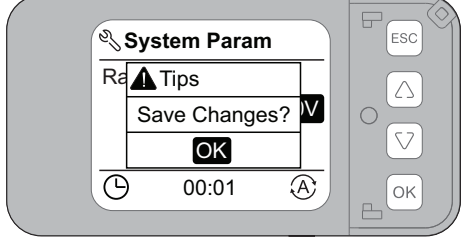
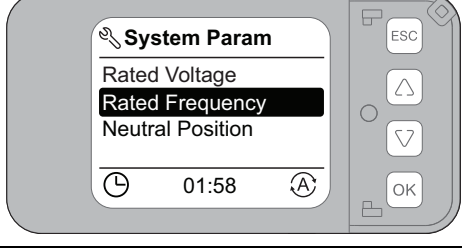
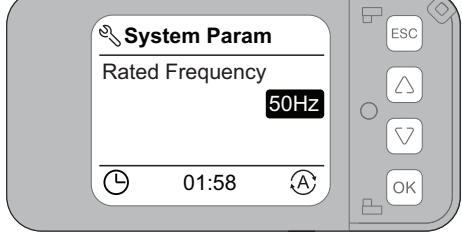
Sub-page name	Sub-page function	Display
<b>System Param</b>	<p><b>Set &amp; Operate</b> page navigates to more maintenance options in the display and click <b>System Param</b> to set nominal values.</p> <p><b>System Param</b> page navigates to more parameter options</p>	
<b>Rated Voltage</b>	<p><b>Rated Voltage</b> is a sub-page of <b>System Param</b>.</p> <p>Click <b>Rated Voltage</b> to set nominal values of voltage.</p>	
	<p>Navigate to select different rate voltage:</p> <ul style="list-style-type: none"> <li>• 2 P : 220 V, 230 V, 240 V, 250 V</li> <li>• 3 P and 4 P: 380 V, 400 V, 415 V, 440 V</li> </ul>	
<b>Confirm Operation</b>	<p><b>Confirm Operation</b> window is to confirm the <b>Rated Voltage</b> and click <b>OK</b> to save changes.</p>	
<b>Rated Frequency</b>	<p><b>Rated Frequency</b> is a sub-page of <b>System Parameters</b>.</p> <p>Click <b>Rated Frequency</b> to set nominal values of frequency.</p>	
	<p>Navigate to select different rated frequency:</p> <ul style="list-style-type: none"> <li>• 50 Hz</li> <li>• 60 Hz</li> </ul>	

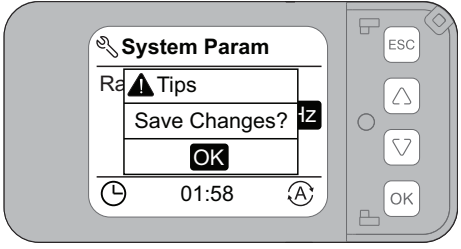
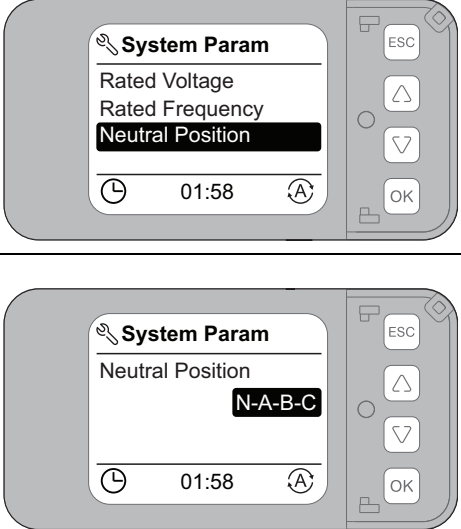
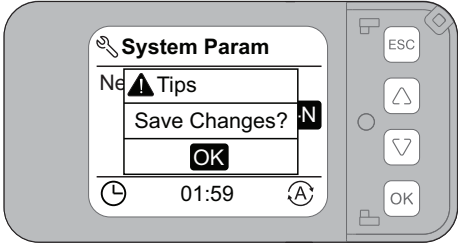
Sub-page name	Sub-page function	Display
<b>Confirm Operation</b>	<b>Confirm Operation</b> window is to confirm the <b>Rated Frequency</b> and click <b>OK</b> to save changes.	 <p>The screenshot shows the 'System Param' screen with a confirmation dialog box. The dialog box contains a warning icon and the text 'Save Changes?' with an 'OK' button. The background shows 'Rated Frequency' and a timer '01:58'.</p>
<b>Neutral Position</b>	<p><b>Neutral Position</b> is a sub-page of <b>System Param</b>.</p> <p>Click <b>Neutral Position</b> to set nominal values of Neutral Position.</p> <p>Navigate to select different neutral position:</p> <ul style="list-style-type: none"> <li>• N-A-B-C</li> <li>• A-B-C-N</li> <li>• N-C-B-A</li> <li>• C-B-A-N</li> </ul>	 <p>The top screenshot shows the 'System Param' screen with 'Neutral Position' highlighted in the menu. The bottom screenshot shows the 'System Param' screen with 'Neutral Position' selected and 'N-A-B-C' displayed as the chosen option. Both screenshots show a timer of '01:58'.</p>
<b>Confirm Operation</b>	<b>Confirm Operation</b> window is to confirm the <b>Neutral Position</b> and click <b>OK</b> to save changes.	 <p>The screenshot shows the 'System Param' screen with a confirmation dialog box. The dialog box contains a warning icon and the text 'Save Changes?' with an 'OK' button. The background shows 'Neutral Position' and a timer '01:59'.</p>

## Application Sub-Page

The below table provide the details of the **Application** sub-pages:

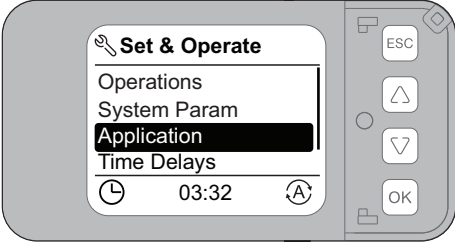
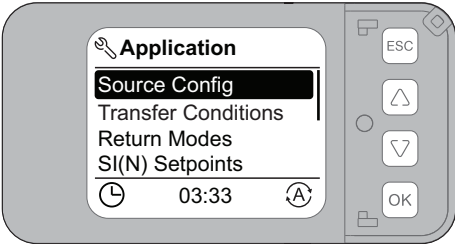
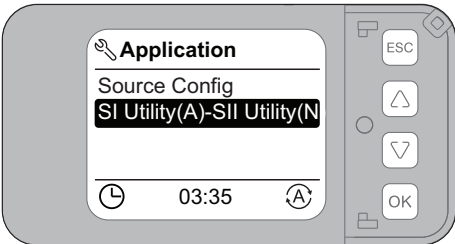
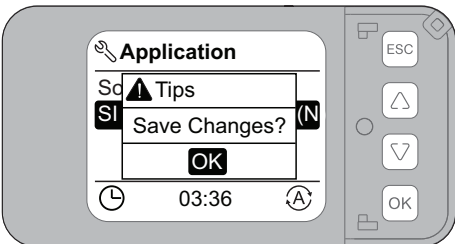
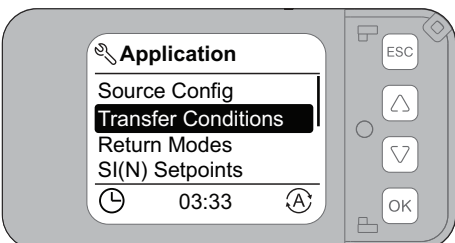
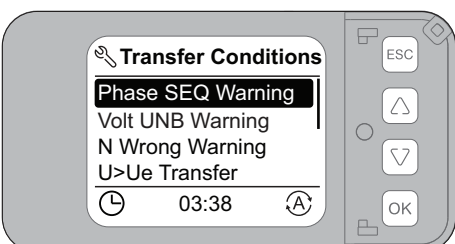
Sub-page name	Sub-page function	Display
<b>Application</b>	<b>Set &amp; Operate</b> page navigates to more maintenance options in the display and click <b>Application</b> to set the type of source, threshold, time delays and transfer conditions.	
<b>Source Config</b>	<b>Source Config</b> is a sub-page of <b>Application</b> . Click <b>Source Config</b> to set the type of source.	
	Select different source type and priorities and click source configuration to set type of source <ul style="list-style-type: none"> <li>• SI Utility (N)-SII Utility (A)</li> <li>• SI-Utility (N) / SII-Genset (A)</li> <li>• SI-Genset (A) / SII-Utility (N)</li> <li>• SII Utility (N)-SI Utility (A)</li> </ul>	
<b>Confirm Operation</b>	<b>Confirm Operation</b> window is to confirm the <b>Source Config</b> and click <b>OK</b> to save changes.	
<b>Transfer Conditions</b>	<b>Transfer Conditions</b> is a sub-page of <b>Application</b> . Click <b>Transfer Conditions</b> to set the conditions.	
<b>Phase SEQ Warning</b>	<b>Phase SEQ Warning</b> is a sub-page of <b>Transfer Conditions</b> .	

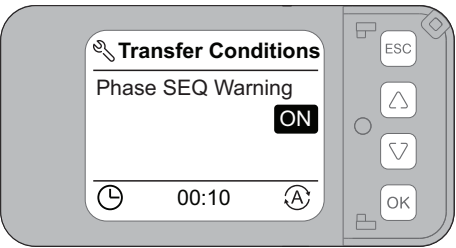
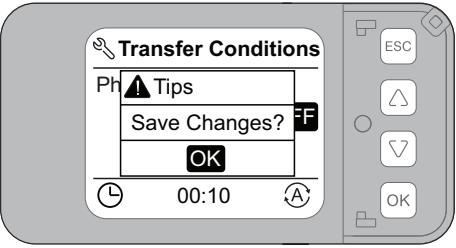
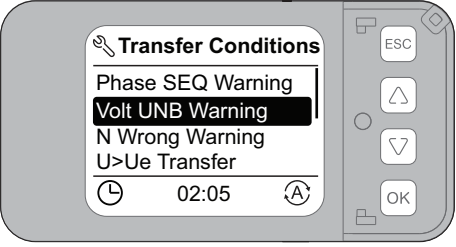
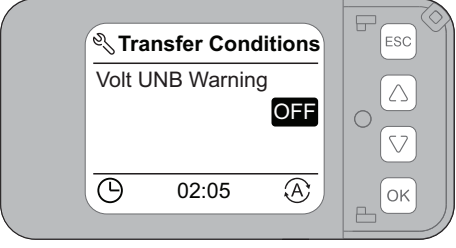
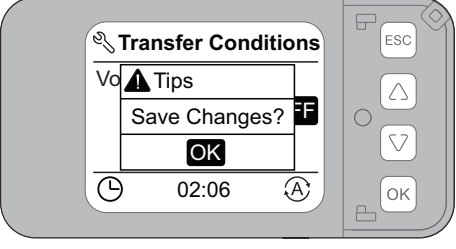
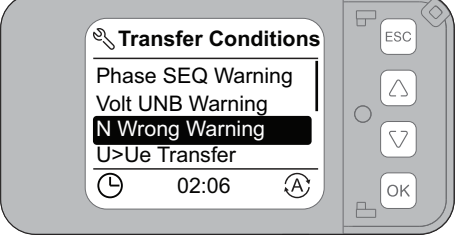
Sub-page name	Sub-page function	Display
	Select <b>Phase SEQ Warning</b> to set the warning conditions: <ul style="list-style-type: none"> <li>• <b>ON</b>: enable phase sequence detection.</li> <li>• <b>OFF</b>: disable phase sequence detection.</li> </ul> <b>NOTE:</b> <ul style="list-style-type: none"> <li>• IEC default : On</li> <li>• GB default : Off</li> </ul>	
<b>Confirm Operation</b>	<b>Confirm Operation</b> window is to confirm the <b>Phase SEQ Warning</b> and click <b>OK</b> to save changes.	
<b>Volt UNB Warning</b>	<b>Volt UNB Warning</b> is a sub-page of <b>Transfer Conditions</b> .	
	Select <b>Volt UNB Warning</b> to set the warning conditions: <ul style="list-style-type: none"> <li>• <b>ON</b>: enable voltage unbalance detection.</li> <li>• <b>OFF</b>: disable voltage unbalance detection.</li> </ul> <b>NOTE:</b> Default setting is shown as disabled.	
<b>Confirm Operation</b>	<b>Confirm Operation</b> window is to confirm the <b>Volt UNB Warning</b> and click <b>OK</b> to save changes.	
<b>N Wrong Warning</b>	<b>NI Wrong Warning</b> is a sub-page of <b>Transfer Conditions</b> .	

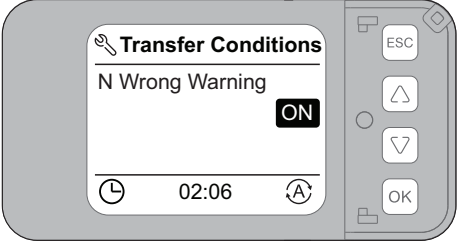
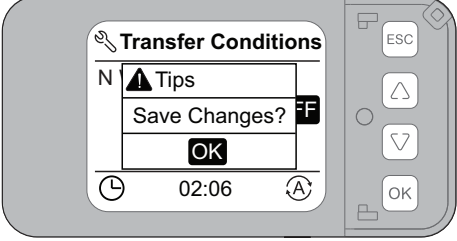
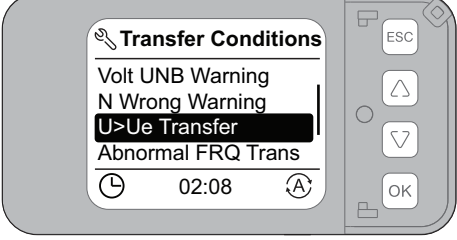
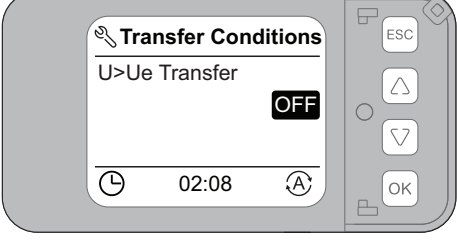
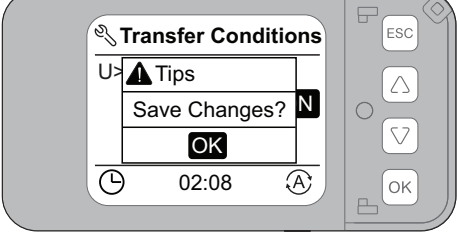
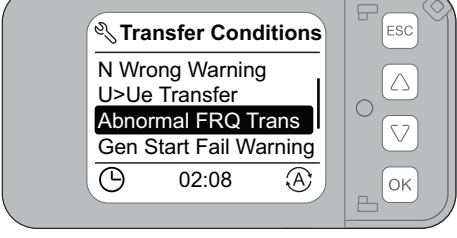
Sub-page name	Sub-page function	Display
	Select <b>N Wrong Warning</b> to set the warning conditions: <ul style="list-style-type: none"> <li>• <b>ON</b>: enable neutral wrong detection.</li> <li>• <b>OFF</b>: disable neutral wrong detection.</li> </ul> <b>NOTE:</b> <ul style="list-style-type: none"> <li>• IEC default : On</li> <li>• GB default : Off</li> </ul>	
<p><b>Confirm Operation</b></p>	<p><b>Confirm Operation</b> window is to confirm the <b>N Wrong Warning</b> and click <b>OK</b> to save changes.</p>	
<p><b>U &gt; UeTransfer</b></p>	<p><b>U &gt; Ue Transfer</b> is a sub-page of <b>Transfer Conditions</b>.</p>	
	Select <b>U &gt; Ue Transfer</b> to set the conditions: <ul style="list-style-type: none"> <li>• <b>ON</b>: enable over voltage detection.</li> <li>• <b>OFF</b>: disable over voltage detection.</li> </ul> <b>NOTE:</b> Default setting is shown as disabled.	
<p><b>Confirm Operation</b></p>	<p><b>Confirm Operation</b> window is to confirm the <b>U &gt; Uee Transfer</b> and click <b>OK</b> to save changes.</p>	
<p><b>Abnormal FRQ Trans</b></p>	<p><b>Abnormal FRQ Trans</b> is a sub-page of <b>Transfer Conditions</b>.</p>	

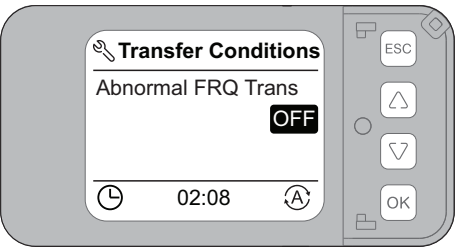
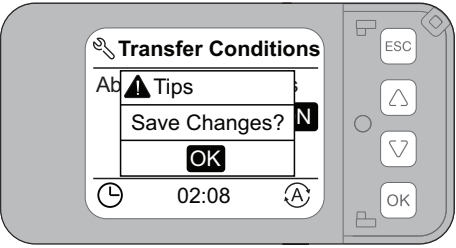
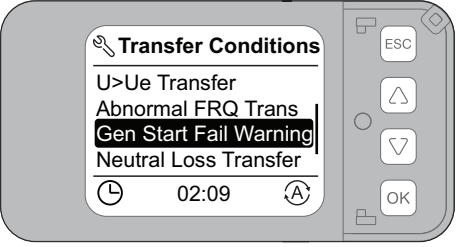
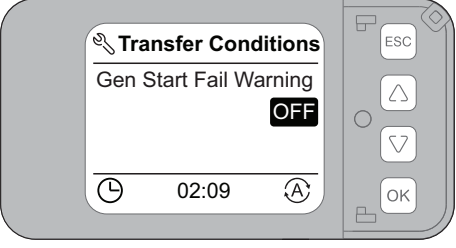
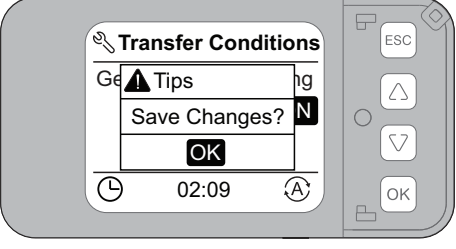
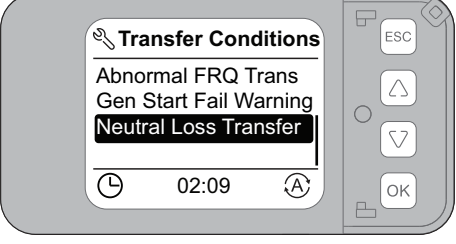
Sub-page name	Sub-page function	Display
	Select <b>Abnormal FRQ Trans</b> to set the conditions: <ul style="list-style-type: none"> <li>• <b>ON</b>: enable abnormal frequency detection.</li> <li>• <b>OFF</b>: disable abnormal frequency detection.</li> </ul> <b>NOTE:</b> Default setting is shown as disabled.	
<b>Confirm Operation</b>	<b>Confirm Operation</b> window is to confirm the <b>Abnormal FRQ Trans</b> and click <b>OK</b> to save changes.	
<b>Gen Start Fail Warning</b>	<b>Gen Start Fail Warning</b> is a sub-page of <b>Transfer Conditions</b> .	
	Select <b>Gen Start Fail Warning</b> to set the conditions: <ul style="list-style-type: none"> <li>• <b>ON</b>: enable gen start fail warning detection.</li> <li>• <b>OFF</b>: disable gen start fail warning detection.</li> </ul> <b>NOTE:</b> Default setting is shown as disabled.	
<b>Confirm Operation</b>	<b>Confirm Operation</b> window is to confirm the <b>Gen Start Fail Warning</b> and click <b>OK</b> to save changes.	
<b>Neutral Loss Transfer</b>	<b>Neutral Loss Transfer</b> is a sub-page of <b>Transfer Conditions</b> .	

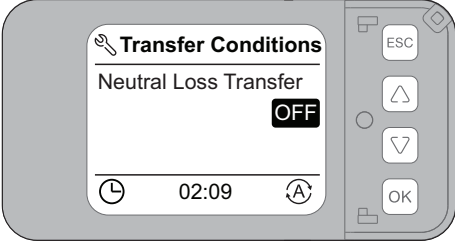
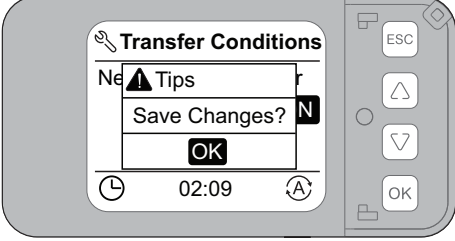
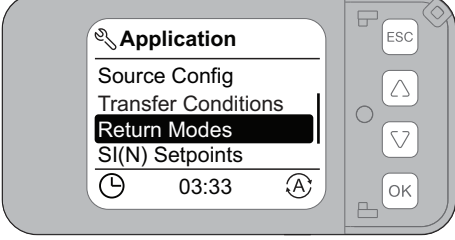
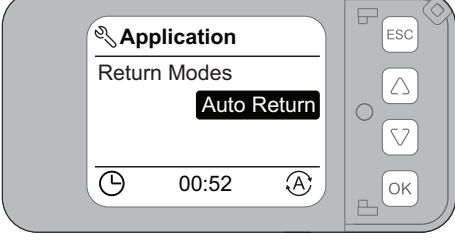
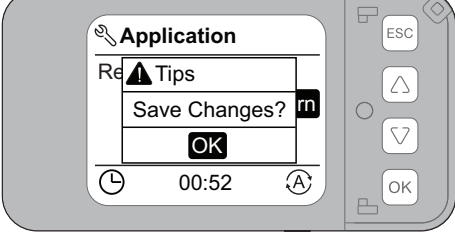
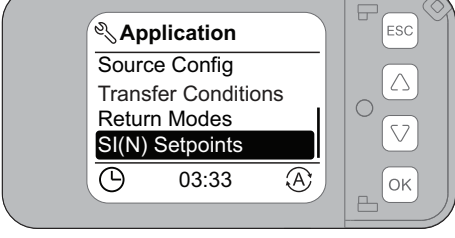
Sub-page name	Sub-page function	Display
	Select <b>Neutral Loss Transfer</b> to set the conditions: <ul style="list-style-type: none"> <li>• <b>ON</b>: enable neutral loss transfer detection.</li> <li>• <b>OFF</b>: disable neutral loss transfer detection.</li> </ul> <b>NOTE:</b> Default setting is shown as disabled.	
<b>Confirm Operation</b>	<b>Confirm Operation</b> window is to confirm the <b>Neutral Loss Transfer</b> and click <b>OK</b> to save changes.	
<b>Return Modes</b>	<b>Return Modes</b> is a sub-page of <b>Application</b> .	
	Select <b>Return Modes</b> to set the transfer modes. <ul style="list-style-type: none"> <li>• Auto Return</li> <li>• Non Return</li> </ul>	
<b>Confirm Operation</b>	<b>Confirm Operation</b> window is to confirm the <b>Return Modes</b> and click <b>OK</b> to save changes.	
<b>SI(N) Setpoints</b>	<b>SI(N) Setpoints</b> is a sub-page of <b>Application</b> . Select <b>SI(N) Setpoints</b> to set the threshold.	

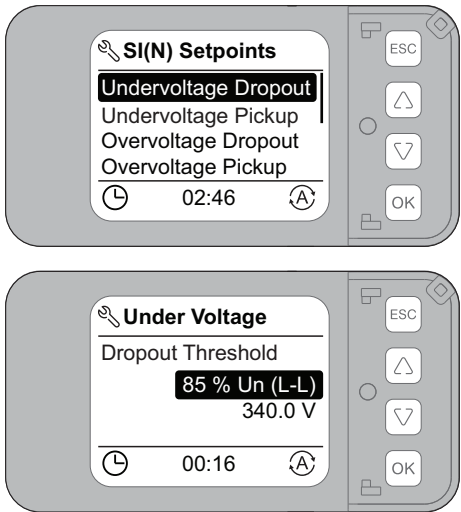
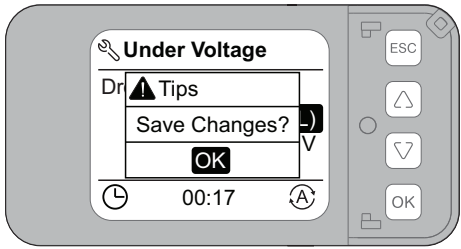
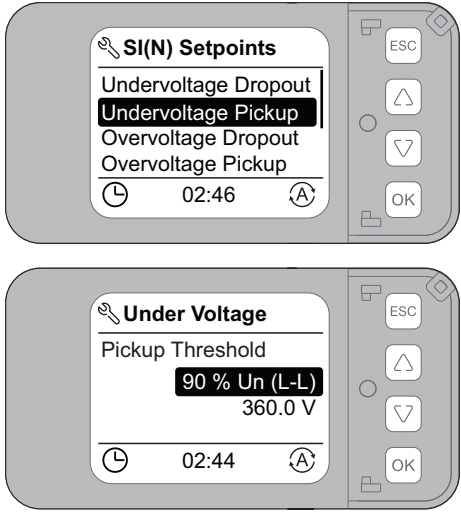
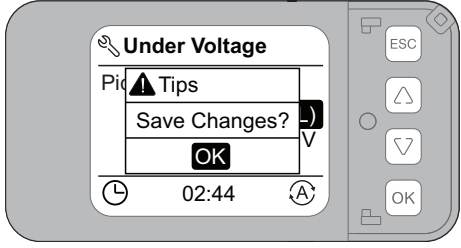
Sub-page name	Sub-page function	Display
<p><b>Undervoltage Dropout</b></p>	<p><b>Undervoltage Dropout</b> is a sub-page of <b>SI(N) Setpoints</b>.</p> <p><b>Under Voltage</b> page navigates to more set point options in the display for under voltage dropout threshold.</p> <ul style="list-style-type: none"> <li>• The % and real value will be displayed together.</li> <li>• % can be set while the real value changed dynamically.</li> <li>• The range of under voltage dropout can be 70% - 95% of rated voltage with step of 1%.</li> <li>• Default value is 85%</li> <li>• 3P/4P: 85% Un (L-L)</li> <li>• 2P: 85% Un (L-N)</li> </ul>	
<p><b>Confirm Operation</b></p>	<p><b>Confirm Operation</b> window is to confirm the <b>Under Voltage</b> and click <b>OK</b> to save changes.</p>	
<p><b>Undervoltage Pickup</b></p>	<p><b>Undervoltage Pickup</b> is a sub-page of <b>SI(N) Setpoints</b>.</p> <p><b>Under Voltage</b> page navigates to more set point options in the display for under voltage pickup threshold.</p> <ul style="list-style-type: none"> <li>• The % and real value will be displayed together.</li> <li>• % can be set while the real value changed dynamically.</li> <li>• The range of under voltage pickup can be 85% - 100% of rated voltage with step of 1%.</li> <li>• Default value is 90%.</li> </ul>	
<p><b>Confirm Operation</b></p>	<p><b>Confirm Operation</b> window is to confirm the <b>Under Voltage</b> and click <b>OK</b> to save changes.</p>	

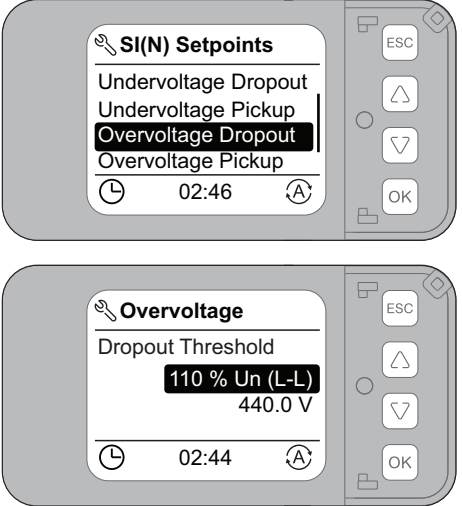
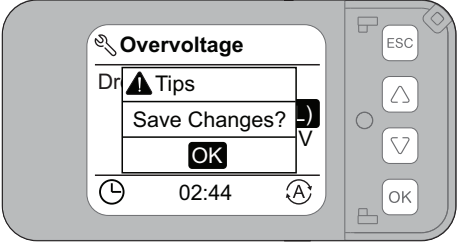
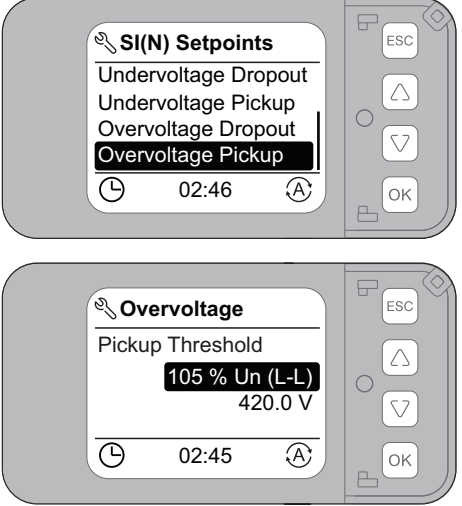
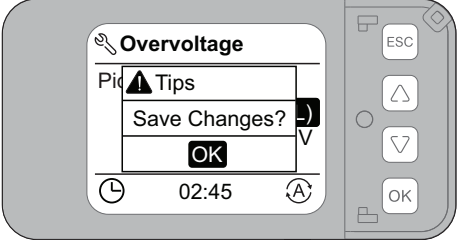
Sub-page name	Sub-page function	Display
<p><b>Overvoltage Dropout</b></p>	<p><b>Overvoltage Dropout</b> is a sub-page of <b>SI(N) Setpoints</b>.</p> <p><b>Overvoltage</b> page navigates to more set point options in the display for over voltage dropout threshold.</p> <ul style="list-style-type: none"> <li>• The % and real value will be displayed together.</li> <li>• % can be set while the real value changed dynamically.</li> <li>• The range of over voltage dropout can be 105% - 135% of rated voltage with step of 1%.</li> <li>• Default value is 110%.</li> </ul>	
<p><b>Confirm Operation</b></p>	<p><b>Confirm Operation</b> window is to confirm the <b>Over Voltage</b> and click <b>OK</b> to save changes.</p>	
<p><b>Overvoltage Pickup</b></p>	<p><b>Overvoltage Pickup</b> is a sub-page of <b>SI(N) Setpoints</b>.</p> <p><b>Overvoltage</b> page navigates to more set point options in the display for over voltage pickup threshold.</p> <ul style="list-style-type: none"> <li>• The % and real value will be displayed together.</li> <li>• % can be set while the real value changed dynamically.</li> <li>• The range of over voltage pickup can be 100% - 115% of rated voltage with step of 1%.</li> <li>• Default value is 105%.</li> </ul>	
<p><b>Confirm Operation</b></p>	<p><b>Confirm Operation</b> window is to confirm the <b>Over Voltage</b> and click <b>OK</b> to save changes.</p>	

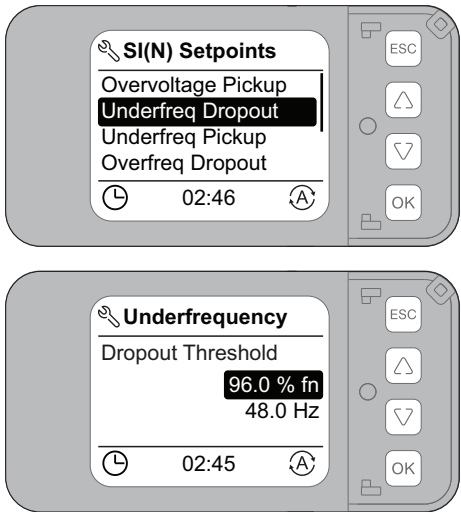
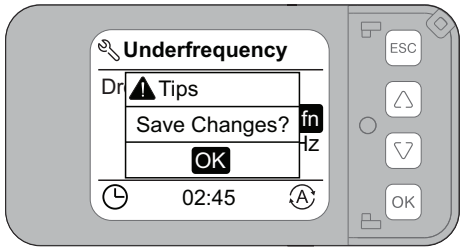
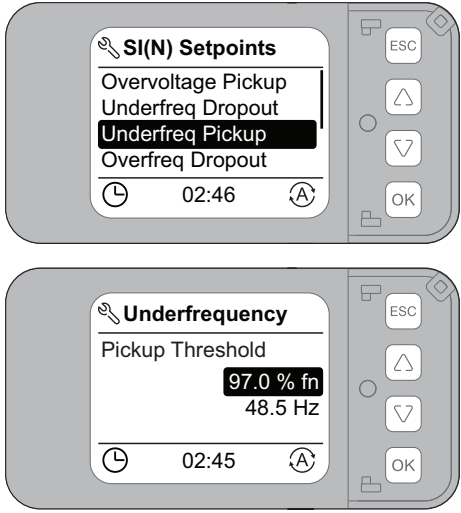
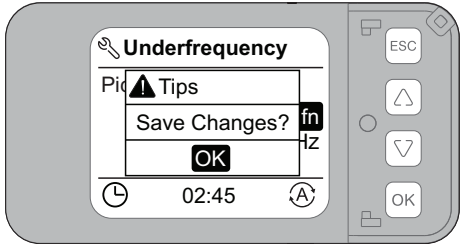
Sub-page name	Sub-page function	Display
<p><b>Underfreq Dropout</b></p>	<p><b>Underfreq Dropout</b> is a sub-page of <b>SI(N) Setpoints</b>.</p> <p><b>Underfrequency</b> page navigates to more set point options in the display for under frequency dropout threshold.</p> <ul style="list-style-type: none"> <li>• The % and real value will be displayed together.</li> <li>• % can be set while the real value changed dynamically.</li> <li>• The range of under frequency dropout can be 80%-98% of rated frequency with step of 0.5%.</li> <li>• Default value is 96%.</li> </ul>	
<p><b>Confirm Operation</b></p>	<p><b>Confirm Operation</b> window is to confirm the <b>Underfrequency</b> and click <b>OK</b> to save changes.</p>	
<p><b>Underfreq Pickup</b></p>	<p><b>Underfreq Pickup</b> is a sub-page of <b>SI(N) Setpoints</b>.</p> <p><b>Underfrequency</b> page navigates to more set point options in the display for under frequency pickup threshold.</p> <ul style="list-style-type: none"> <li>• The % and real value will be displayed together.</li> <li>• % can be set while the real value changed dynamically.</li> <li>• The range of under frequency pickup can be 85%-100% of rated frequency with step of 0.5%.</li> <li>• Default value is 97%.</li> </ul>	
<p><b>Confirm Operation</b></p>	<p><b>Confirm Operation</b> window is to confirm the <b>Underfrequency</b> and click <b>OK</b> to save changes.</p>	

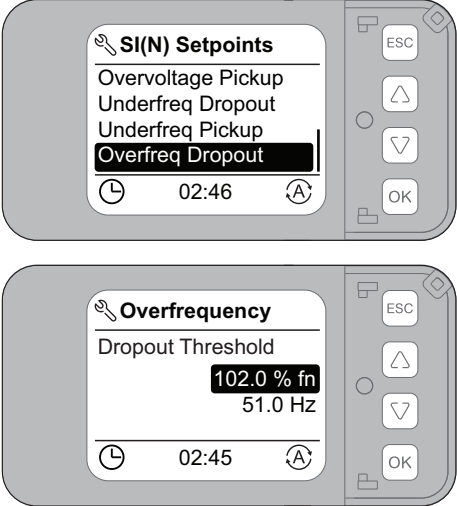
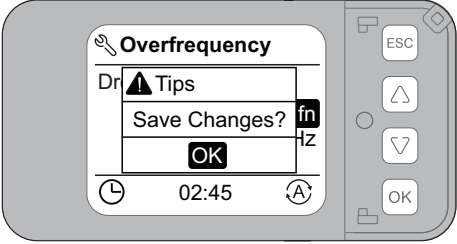
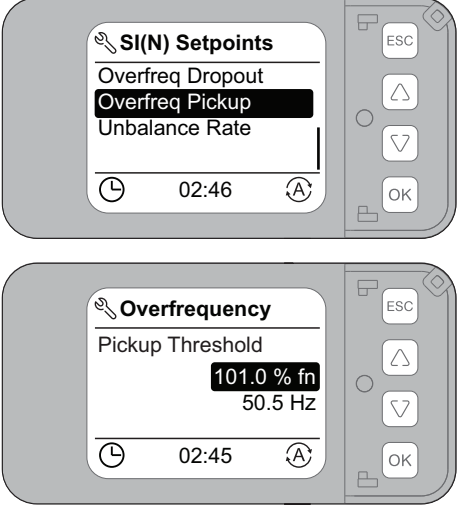
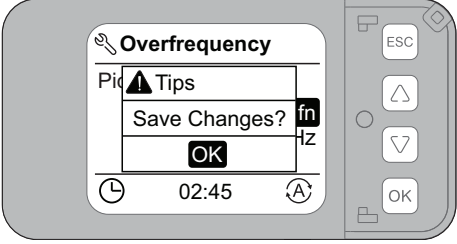
Sub-page name	Sub-page function	Display
<p><b>Overfreq Dropout</b></p>	<p><b>Overfreq Dropout</b> is a sub-page of <b>SI(N) Setpoints</b>.</p> <p><b>Overfrequency</b> page navigates to more set point options in the display for over frequency dropout threshold.</p> <ul style="list-style-type: none"> <li>• The % and real value will be displayed together.</li> <li>• % can be set while the real value changed dynamically.</li> <li>• The range of over frequency dropout can be 101% - 120% of rated voltage with step of 0.5%.</li> <li>• Default value is 102%.</li> </ul>	
<p><b>Confirm Operation</b></p>	<p><b>Confirm Operation</b> window is to confirm the <b>Overfrequency</b> and click <b>OK</b> to save changes.</p>	
<p><b>Overfreq Pickup</b></p>	<p><b>Overfreq Pickup</b> is a sub-page of <b>SI(N) Setpoints</b>.</p> <p><b>Overfrequency</b> page navigates to more set point options in the display for over frequency pickup threshold.</p> <ul style="list-style-type: none"> <li>• The % and real value will be displayed together.</li> <li>• % can be set while the real value changed dynamically.</li> <li>• The range of over frequency pickup can be 100% - 115% of rated voltage with step of 0.5%.</li> <li>• Default value is 101%.</li> </ul>	
<p><b>Confirm Operation</b></p>	<p><b>Confirm Operation</b> window is to confirm the <b>Overfrequency</b> and click <b>OK</b> to save changes.</p>	

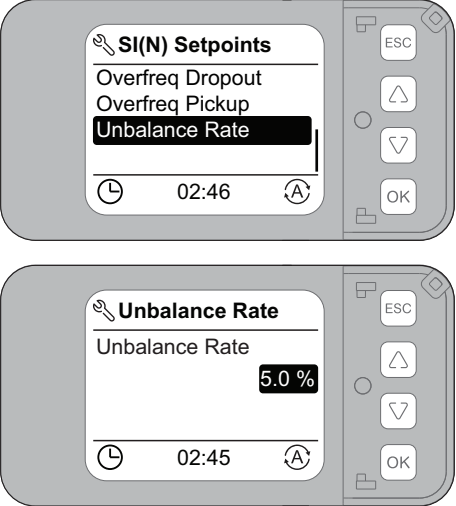
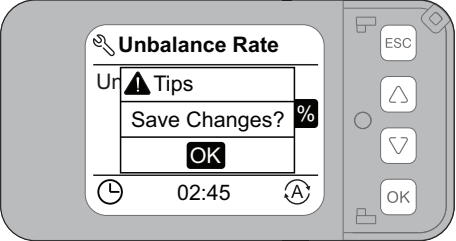
Sub-page name	Sub-page function	Display
<p><b>Unbalance Rate</b></p>	<p><b>Unbalance Rate</b> is a sub-page of <b>SI(N) Setpoints</b>.</p> <p><b>Unbalance Rate</b> page navigates to more set point options in the display for unbalance rate.</p> <ul style="list-style-type: none"> <li>• The % and real value will be displayed together.</li> <li>• % can be set while the real value changed dynamically.</li> <li>• The range of unbalanced rate from 2% to 30%.</li> <li>• Default value is Disabled.</li> </ul>	 <p>The top screenshot shows the 'SI(N) Setpoints' menu with 'Unbalance Rate' selected. The bottom screenshot shows the 'Unbalance Rate' configuration screen with '5.0 %' set.</p>
<p><b>Confirm Operation</b></p>	<p><b>Confirm Operation</b> window is to confirm the <b>Unbalance Rate</b> and click <b>OK</b> to save changes.</p>	 <p>The screenshot shows the 'Unbalance Rate' Confirm Operation window with a 'Save Changes?' dialog box.</p>

## Time Delays Sub-Page

The below table provide the details of the **Time Delays** sub-pages:

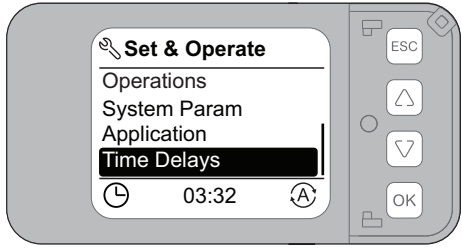
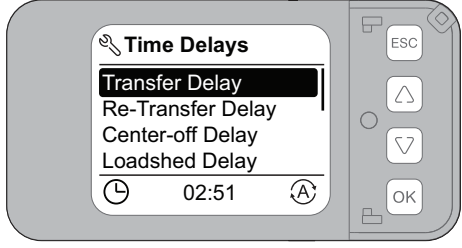
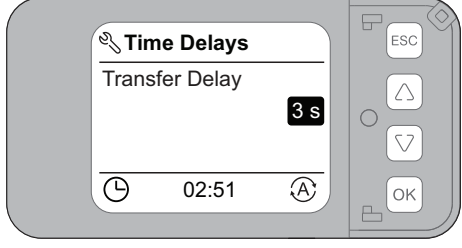
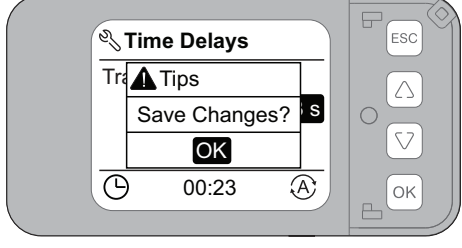
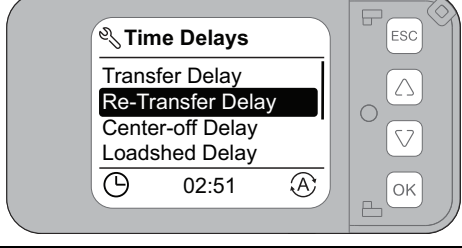
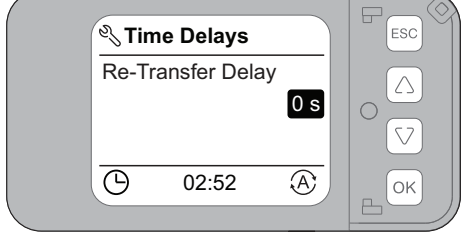
Sub-page name	Sub-page function	Display
Time Delays	<b>Set &amp; Operate</b> page navigates to more maintenance option in the display and click <b>Time Delays</b> to set transfer times delay for different application.	
Transfer Delay	<b>Transfer Delay</b> is a sub-page of <b>Time Delays</b> . Click <b>Transfer Delay</b> to set transfer delay and click <b>OK</b> .	
	<ul style="list-style-type: none"> <li>Use up or down button to set it. The range of transfer time is from 0-1800 s with step of 1 s.</li> <li>Default value is 0 s.</li> </ul>	
Confirm Operation	<b>Confirm Operation</b> window is to confirm the <b>Transfer Delay</b> and click <b>OK</b> to save changes.	
Re-Transfer Delay	<b>Re-Transfer Delay</b> is a sub-page of <b>Time Delays</b> . Click <b>Re-Transfer Delay</b> to set re-transfer delay and click <b>OK</b> .	
	<ul style="list-style-type: none"> <li>Use up or down button to set it. The range of re-transfer time is from 0-3600 s with step of 1 s.</li> <li>Default value is 0 s.</li> </ul>	

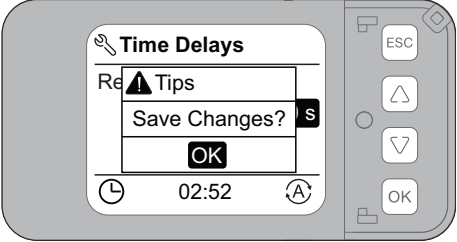
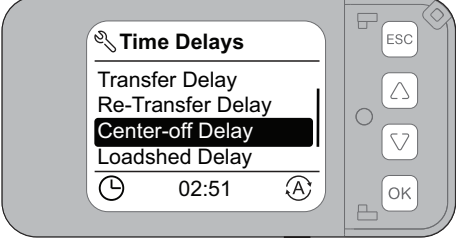
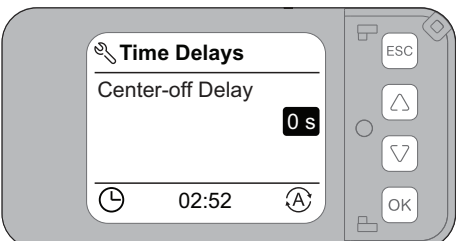
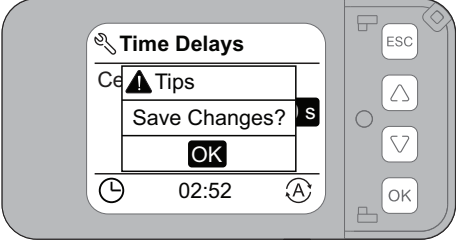
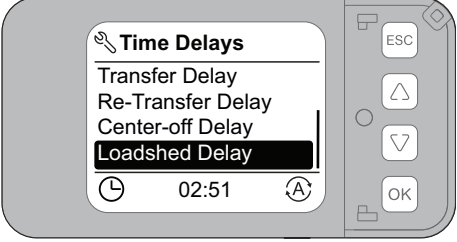
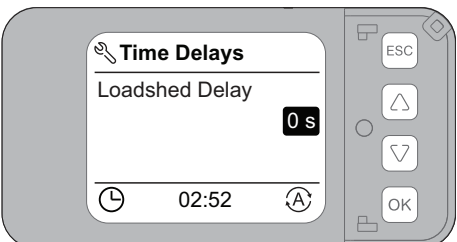
Sub-page name	Sub-page function	Display
<b>Confirm Operation</b>	<b>Confirm Operation</b> window is to confirm the <b>Re-Transfer Delay</b> and click <b>OK</b> to save changes.	
<b>Center-off Delay</b>	<p><b>Center-off Delay</b> is a sub-page of <b>Time Delays</b>.</p> <p>Click <b>Center-off Delay</b> to set center-off delay and click <b>OK</b>.</p> <ul style="list-style-type: none"> <li>• Use up or down button to set it. The range of centre off delay is from 0-30 s with step of 1 s.</li> <li>• Default value is 0 s.</li> </ul>	 
<b>Confirm Operation</b>	<b>Confirm Operation</b> window is to confirm the <b>Center-off Delay</b> and click <b>OK</b> to save changes.	
<b>Loadshed Delay</b>	<p><b>Loadshed Delay</b> is a sub-page of <b>Time Delays</b>.</p> <p>Click <b>Loadshed Delay</b> to set load shedding delay and click <b>OK</b>.</p> <ul style="list-style-type: none"> <li>• Use up or down button to set the value.</li> <li>• The range of load shedding delay is from 0-15 with step of 1 s.</li> <li>• Default value is 0 s.</li> </ul>	 

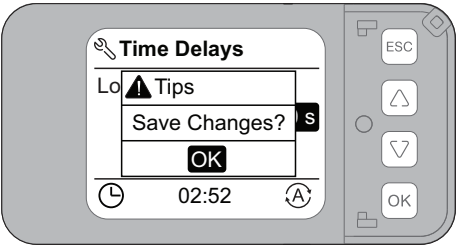
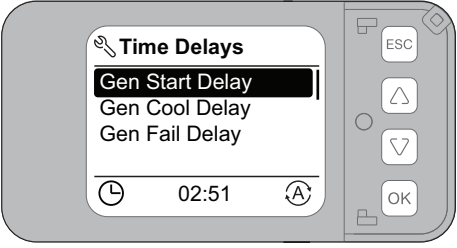
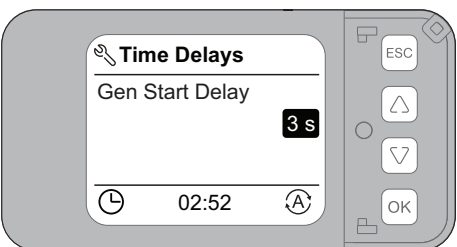
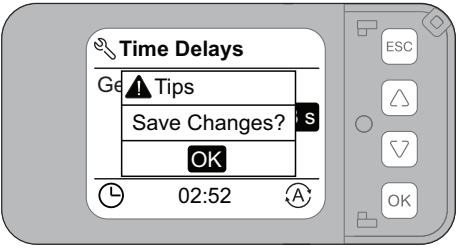
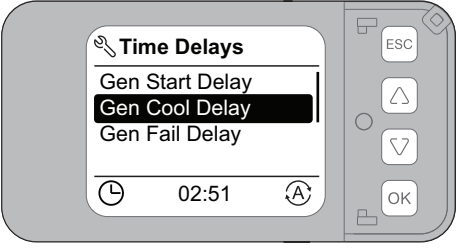
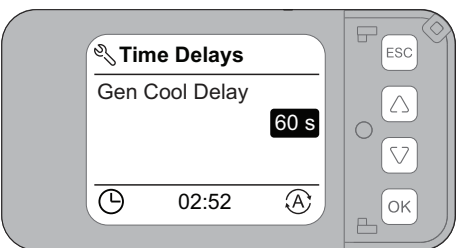
Sub-page name	Sub-page function	Display
<p><b>Confirm Operation</b></p>	<p><b>Confirm Operation</b> window is to confirm the <b>Loadshed Delay</b> and click <b>OK</b> to save changes.</p>	
<p><b>Genset Start Delay</b></p>	<p><b>Genset Start Delay</b> is a sub-page of <b>Time Delays</b>. Click <b>Genset Start Delay</b> to set genset delay and click <b>OK</b>.</p> <ul style="list-style-type: none"> <li>• Use up or down button to set it. The range of genset start time is from 0-120 s with step of 1 s.</li> <li>• Default value is 0 s.</li> </ul>	 
<p><b>Confirm Operation</b></p>	<p><b>Confirm Operation</b> window is to confirm the <b>Genset Start Delay</b> and click <b>OK</b> to save changes.</p>	
<p><b>Gen Cool Delay</b></p>	<p><b>Gen Cool Delay</b> is a sub-page of <b>Time Delays</b>. Click <b>Gen Cool Delay</b> to set genset cooling down delay and click <b>OK</b>.</p> <ul style="list-style-type: none"> <li>• Use up or down button to set it. The range of genset cooling down delay is from 0 to 3600 s with step of 1 s.</li> <li>• Default value is 60 s.</li> </ul>	 

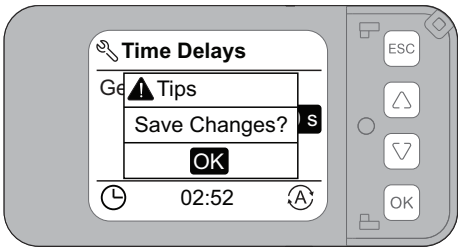
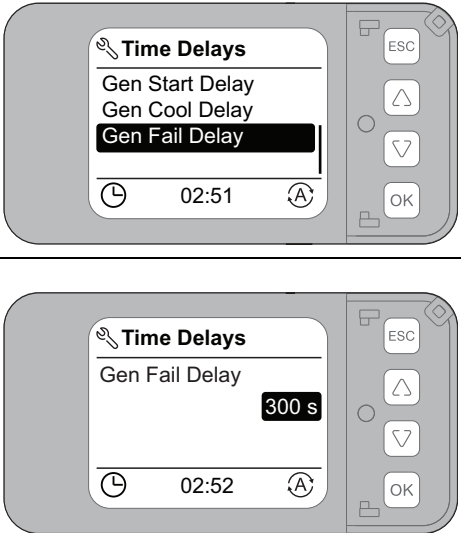
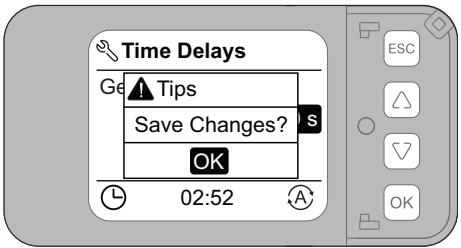
Sub-page name	Sub-page function	Display
<p><b>Confirm Operation</b></p>	<p><b>Confirm Operation</b> window is to confirm the <b>Gen Cool Delay</b> and click <b>OK</b> to save changes.</p>	
<p><b>Gen Fail Delay</b></p>	<p><b>Gen Fail Delay</b> is a sub-page of <b>Time Delays</b>. Click <b>Gen Fail Delay</b> to set genset ready alarm delay and click <b>OK</b>.</p> <ul style="list-style-type: none"> <li>• Genset failure delay is from 0 ~300 s. Default value is 300 s.</li> <li>• Use up or down button to set it.</li> <li>• The range of genset ready alarm is from 0-15 with step of 1 s.</li> <li>• Default value is 0 s.</li> </ul> <p><b>NOTE:</b> This function of genset ready alarm can be disabled.</p>	
<p><b>Confirm Operation</b></p>	<p><b>Confirm Operation</b> window is to confirm the <b>Gen Fail Delay</b> and click <b>OK</b> to save changes.</p>	

## Settings Sub-Page

The below table provide the details of the **Settings** sub-pages:

Sub-page name	Sub-page function	Display
<b>Settings</b>	<p><b>Set &amp; Operate</b> page navigates to more set &amp; operate option in the display.</p> <p>Click <b>Settings</b> for accessories commissioning, reset and password settings.</p>	
<b>Accessories</b>	<p><b>Accessories</b> is a sub-page of <b>Settings</b>.</p> <p><b>Accessories</b> page navigates to more setting option in the display.</p>	
<b>Modbus</b>	<p><b>Modbus</b> is a sub-page of <b>Accessories</b>.</p> <p>Click <b>Modbus</b> for commissioning.</p> <p><b>NOTE:</b> If the module of Modbus is not inserted, the option will be empty.</p>	
	<p>Select the parameters as below:</p> <ul style="list-style-type: none"> <li>Set the <b>Address</b></li> <li>Set the <b>Baudrate</b></li> </ul> <p><b>NOTE:</b> The odd/even parity is automatically recognized.</p>	
<b>Confirm Operation</b>	<p><b>Confirm Operation</b> window is to confirm the <b>Modbus</b> and click <b>OK</b> to save changes.</p>	
<b>DI Test</b>	<p><b>DI Test</b> is a sub-page of <b>Accessories</b>.</p> <p>Click <b>DI Test</b> for commissioning.</p> <p><b>NOTE:</b> If the module of remote test is not inserted, the option will be empty.</p>	

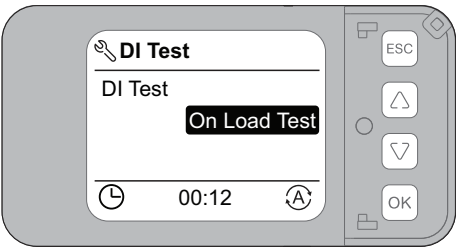
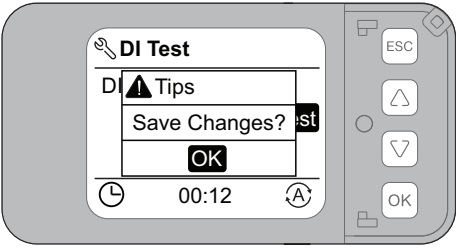
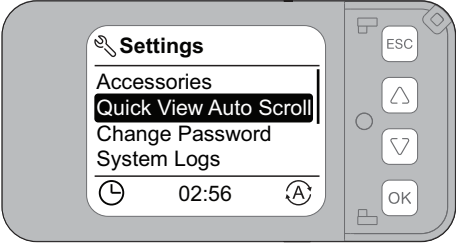
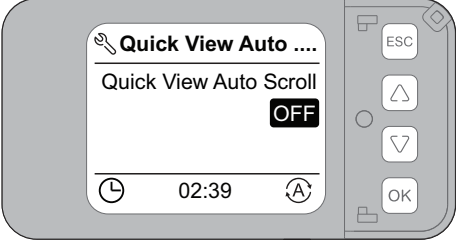
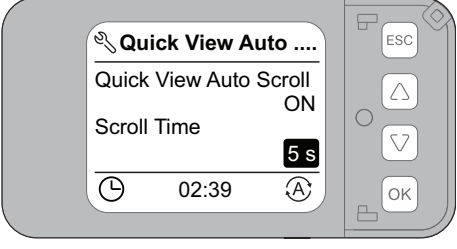
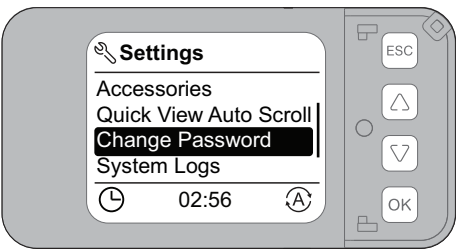

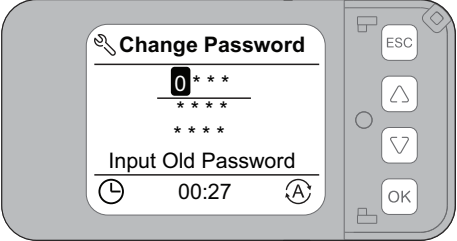
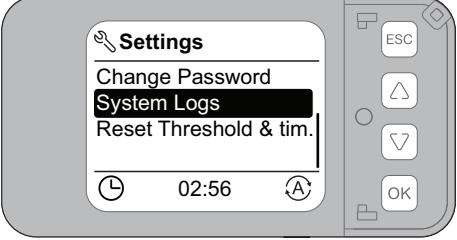
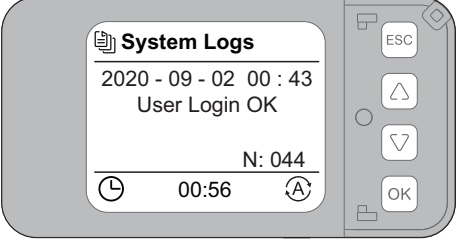
Sub-page name	Sub-page function	Display
	Set <b>On Load Test</b> or <b>Off Load Test</b> .	
<b>Confirm Operation</b>	<b>Confirm Operation</b> window is to confirm the <b>DI Test</b> and click <b>OK</b> to save changes.	
<b>Quick View Auto Scroll</b>	<p><b>Quick View Auto Scroll</b> is a sub-page of <b>Settings</b>.</p> <p><b>Quick View Auto Scroll</b> page navigates to more settings option in the display.</p> <p><b>NOTE:</b> If the module of <b>Quick View Auto Scroll</b> test is not inserted, the option will be empty.</p>	
	<p>Select <b>Quick View Auto Scroll</b> to set the conditions:</p> <ul style="list-style-type: none"> <li>• <b>ON:</b> enable Quick View Auto Scroll detection.</li> <li>• <b>OFF:</b> disable Quick View Auto Scroll detection.</li> </ul> <p><b>NOTE:</b> Default setting is shown as disabled.</p>	
	<p>Select <b>Scroll Time</b> and use up or down button to set it. The range of quick view auto scroll time is from 0 ~300 s with step of 1 s.</p> <p>Default value is 5 s.</p>	
<b>Change Password</b>	<p><b>Change Password</b> is a sub-page of <b>Settings</b>.</p> <p>Click <b>Change Password</b> to change password.</p>	

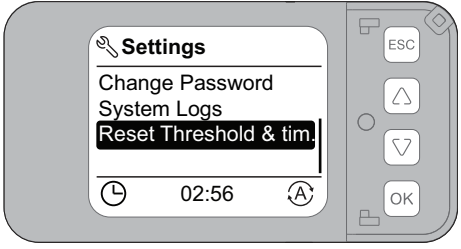
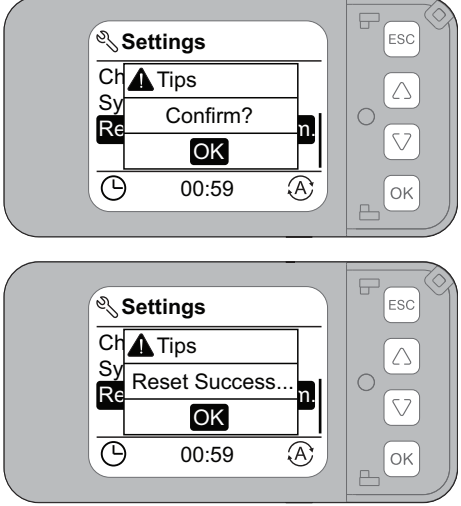
Sub-page name	Sub-page function	Display
	<p>Select the parameters to change password:</p> <ul style="list-style-type: none"> <li>Input 4 digital code to create new password.</li> </ul> <p><b>NOTE:</b> To change or reset the password:</p> <ol style="list-style-type: none"> <li>Change to handle mode.</li> <li>Restart the ATSE.</li> <li>Press <b>OK</b> and <b>ESC</b> button for 10 seconds.</li> </ol> <p><b>NOTE:</b> The step 3 should be performed within 1 minute after step 2.</p>	
<p><b>System Logs</b></p>	<p><b>System Logs</b> is a sub-page of <b>Settings</b>.</p>	
	<p>Select <b>System Logs</b> and use up or down button to set it.</p>	

Sub-page name	Sub-page function	Display
<p><b>Reset Threshold &amp; tim.</b></p>	<p><b>Reset Threshold &amp; tim.</b> is a sub-page of <b>Settings</b>.</p> <p>Click <b>Reset Threshold &amp; tim.</b> to reset the controller.</p> <p>List of values that can be reset:</p> <ul style="list-style-type: none"> <li>• Under Voltage</li> <li>• Over Voltage</li> <li>• Under Frequency</li> <li>• Over Frequency</li> <li>• Unbalance Rate</li> <li>• Transfer Delay (T2)</li> <li>• Center-Off Delay (T4)</li> <li>• Re-Transfer Delay (T6)</li> <li>• Genset Start Delay (T7)</li> <li>• Loadshed Delay (T8)</li> <li>• Genset Cool Delay (T9)</li> <li>• Genset Fail Delay (T10)</li> <li>• On Load Test Delay (T13)</li> <li>• Off Load Test Delay (T14)</li> </ul>	 <p>The screenshot shows the 'Settings' menu with options: Change Password, System Logs, and Reset Threshold &amp; tim. The 'Reset Threshold &amp; tim.' option is highlighted. The time 02:56 is displayed at the bottom of the screen. The right side of the screen shows navigation buttons: ESC, Up, Down, and OK.</p>
<p><b>Confirm Operation</b></p>	<p><b>Confirm Operation</b> window is to confirm the <b>Reset Threshold &amp; tim.</b> and click <b>OK</b> to save changes.</p>	 <p>The top screenshot shows the 'Confirm Operation' dialog box with the text 'Confirm?' and an 'OK' button. The time 00:59 is displayed at the bottom. The bottom screenshot shows the 'Confirm Operation' dialog box with the text 'Reset Success...' and an 'OK' button. The time 00:59 is displayed at the bottom. Both screenshots show the same navigation buttons on the right: ESC, Up, Down, and OK.</p>

## Language Sub-Page

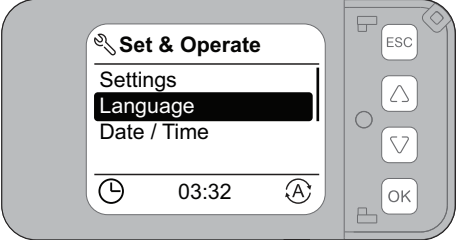
The below table provide the details of the **Language** sub-pages:

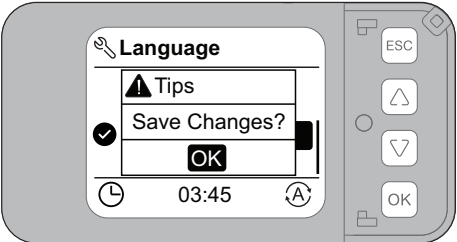
Sub-page name	Sub-page function	Display
<p><b>Language</b></p>	<p><b>Set &amp; Operate</b> page navigates to more set &amp; operate option in the display and click <b>Language</b> to select the preferred language.</p>	 <p>The screenshot shows a touch screen interface with a 'Set &amp; Operate' menu. The menu items are 'Settings', 'Language' (highlighted), and 'Date / Time'. The time displayed is 03:32. On the right side, there are physical buttons for ESC, up arrow, down arrow, and OK.</p>
	<p>Select the display language</p>	 <p>The screenshot shows a touch screen interface with a 'Language' selection screen. The options are '中文', 'Português(BR)', and 'English' (highlighted with a checkmark). The time displayed is 03:45. On the right side, there are physical buttons for ESC, up arrow, down arrow, and OK.</p>
<p><b>Confirm Operation</b></p>	<p><b>Confirm Operation</b> window is to confirm the <b>Language</b> and click <b>OK</b> to save changes.</p>	 <p>The screenshot shows a touch screen interface with a 'Language' confirmation screen. It displays a 'Tips' icon and the text 'Save Changes?' with an 'OK' button. The time displayed is 03:45. On the right side, there are physical buttons for ESC, up arrow, down arrow, and OK.</p>

## Date and Time Sub-Page

The below table provide the details of the **Date / Time** sub-pages:

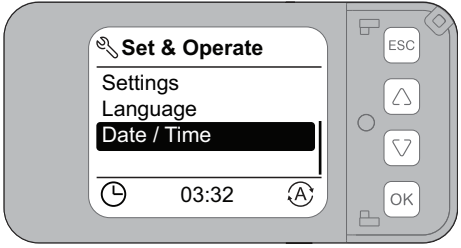
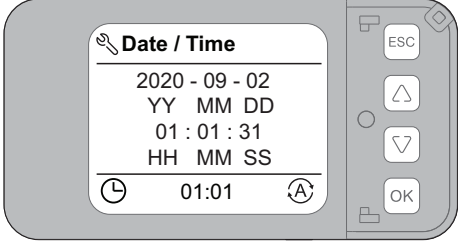
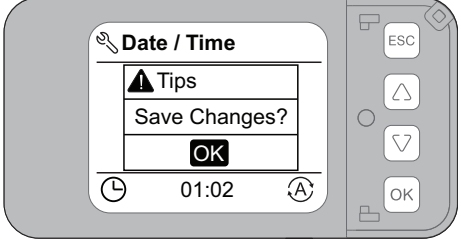
Sub-page name	Sub-page function	Display
<b>Date / Time</b>	<b>Set &amp; operate</b> page navigates to more set & operate option in the display and click <b>Date / Time</b> to set the time.	
	Select the parameters below: <ul style="list-style-type: none"> <li>• Select timer by year/month/day.</li> <li>• Select timer by hour/minutes/seconds.</li> </ul>	
<b>Confirm Operation</b>	<b>Confirm Operation</b> window is to confirm the <b>Date / Time</b> and click <b>OK</b> to save changes.	

## Quick Menu Tour

The location of some frequently used menus are listed in the following table. You can also find the default setting of these item.

Menu	Sub-menu 1	Sub-menu 2	Range	Default
System Param	Rated Voltage	-	please refer to System Parameters Sub-Page, page 115	Ue-220V: 230V, or Ue-400V: 400V, or Ue-208V: 230V, or
	Rated Frequency	-	50 Hz; 60 Hz	50 Hz
	Neutral position	-	N-A-B-C A-B-C-N N-C-B-A C-B-A-N	NABC
Application	Source Config	-	S1 Utility(N) - SII Genset (A); S1 Utility(A) - SII Utility (N); S1 Utility(N) - SII Utility (A); S1 Genset(A) - SII Utility (N)	S1 Utility(N) - SII Genset (A)
	Transfer Conditions	Phase SEQ Warning	ON; OFF	ON (IEC) OFF (China)
		Volt UNB Warning	ON; OFF	OFF

Menu	Sub-menu 1	Sub-menu 2	Range	Default	
		N Wrong Warning	ON; OFF	ON (IEC) OFF (China)	
		U > Ue Transfer	ON; OFF	OFF	
		Abnormal FRQ Trans	ON; OFF	OFF	
		Gen Start Fail Warning	ON; OFF	OFF	
		Neutral Loss Transfer	ON; OFF	OFF	
	Return Modes	-	Auto Return; Non Return; Manual Return (China)	Auto Return	
	SI setpoints	UV dropout	please refer to Application Sub-Page, page 117		85 %
		UV pickup			90 %
		OV dropout			110 %
		OV pickup			105 %
		UF dropout			96 %
		UF pickup			97 %
		OF dropout			102 %
		OF pickup			101 %
		Unbalance rate			2 %-30 %
	SII setpoints	UV dropout	please refer to Application Sub-Page, page 117		85 %
		UV pickup			90 %
		OV dropout			110 %
		OV pickup			105 %
		UF dropout			96 %
		UF pickup			97 %
		OF dropout			102 %
		OF pickup			101 %
		Unbalance rate			2 %-30 %
	Time Delays	Transfer Delay	-	0-1800 s	3 s (IEC) 0 s (China)
		Re-Transfer Delay	-	0-3600 s	60 s (IEC) 0 s (China)
		Center-off Delay	-	0-30 s	0 s
Loadshed Delay		-	0-15 s	0 s	
Gen Start Delay		-	0-120 s	3 s (IEC) 0 s (China)	
Gen Cool Delay		-	0-3600 s	60 s (IEC) 0 s (China)	
Gen Fail Delay		-	15-300 s	300 s	
Settings	Accessories	DI Test (if supported)	ON Load Test; Off Load Test	ON Load Test	
		Modbus (if supported)	Address Baudrate Parity Stop bit	Address = 001 Baudrate = 19200 Parity = Even Stop bit = 1	
	Quick View Auto Scroll	-	ON (1-300 s); OFF	OFF	
Language	-	-	8 languages	English	
Date/Time	-	-	YYYY-MM-DD-HH-MM-SS	2000-01-01 00:00:00	

## External HMI

The External HMI is used to display the settings parameters remotely. It displays the same parameters as shown on ATSE and has higher priority. There are two parts of External HMI:

1. External HMI base, which is mounted on the panel doors.
2. LCD screen with embedded HMI.

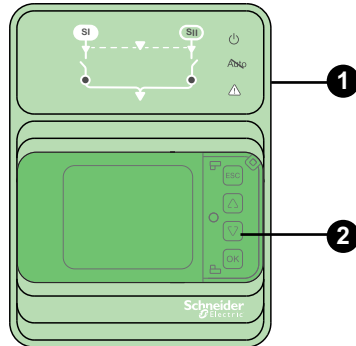

**NOTE:** The function module TPCDIO15 and HMI cable with RJ45 port is needed to connect the external HMI.

# Operations on ATSE

## What's in This Chapter

Overview .....	140
Automatic HMI with Rotary Switch as Embedded HMI .....	141
Active Automatic HMI with LCD Display as Embedded HMI .....	149
Control Mode .....	160

## Overview

ATSE is an equipment containing one or more switching devices for disconnecting load circuits from one supply and connecting to another supply. It is a self-acting transfer switching equipment, including all necessary sensing inputs, monitoring, and control logic for transferring operations.

The two types of transition are:

- Open transition
- Delayed transition

Open transition is a process to break before the transfer operation. It is done intentionally to break the load current from one source prior to making it to the other source, such that the load is not supplied for a period of time.

When the delay transition is activated, the switch will stay in an open circuit (main contact will stay in off position for a period of time). This delay allows the residual voltage of the load to decay within the allowable range.

The delayed transition is recommended when motors are located on the load side. Indeed, in the case of voltage loss on motors, the following may happen:

- When the inductive load loses power, it will generate self excitation voltage due to inertia.
- The self excitation voltage needs a certain time constant to attenuate.
- When the self-excited voltage is 180° different from the voltage of another power supply and superimposed, it will cause about twice the voltage impact.
- When the resistance of the motor is fixed, the current will also be increased to 2 times. In addition, the starting current of the motor is large (6-8 times rated current), so the current shock of 12-16 times may occur.

The setting time of the delay shall ensure that the time length of the motor disconnected from the power supply is equal to or greater than 1.5 open circuit AC time constants of the motor; generally 0.5-1 s.

## Automatic HMI with Rotary Switch as Embedded HMI

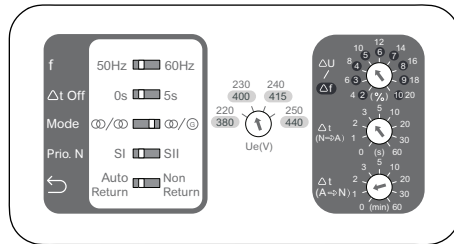

### Preferable Source Selection

TransferPacT Automatic HMI provide an easy way to select the preferred source as normal source.

When the genset is at normal power and the utility is not so stable, make the selection as below:

For TransferPacT Automatic: To select the preferred source, use dip switch to make the selection.

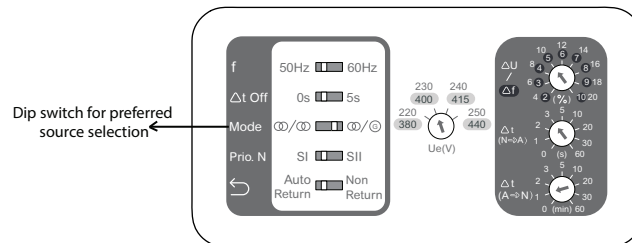

## Transfer Condition

The following are the auto-transfer conditions:

- **Voltage deviation:** Controller monitors two sources, and uses over-voltages and under-voltages thresholds as conditions of source transfer.
- **Frequency deviation:** Controller monitors two sources, and uses over-frequency and under-frequency thresholds as conditions of source transfer.

## Threshold

Description	Settings	Default setting % of nominal	Adjustment range	Note
Voltage	Delta Dropout (under and over voltage)	10%	4 -> 20%	Step of 2%
	Delta Pickup	20% of delta drop out	fixed	fixed
Frequency	Delta Dropout	5%	2 -> 10%	Step of 1%
	Delta Pickup	20% of delta drop out	fixed	fixed

The accuracy of voltage sensing is 1%.

The accuracy of frequency sensing is 0.1%.

## Voltage Dropout and Pickup

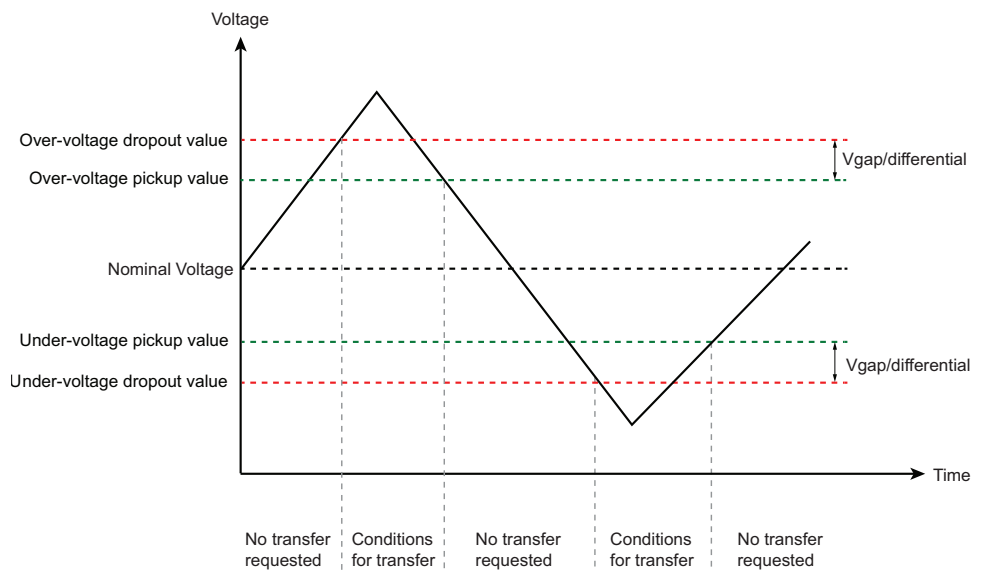

- **Over voltage dropout value:** Above this value, the voltage is out of range and transfer is initiated.
- **Over voltage pickup value:** When voltage goes back from over frequency, it is a condition to go back to normal situation.
- **Under voltage dropout value:** Below this value, the voltage is out of range and transfer is initiated.
- **Under voltage pickup value:** When voltage goes back from under voltage, it is a condition to go back to normal situation.

## Frequency Dropout and Pickup

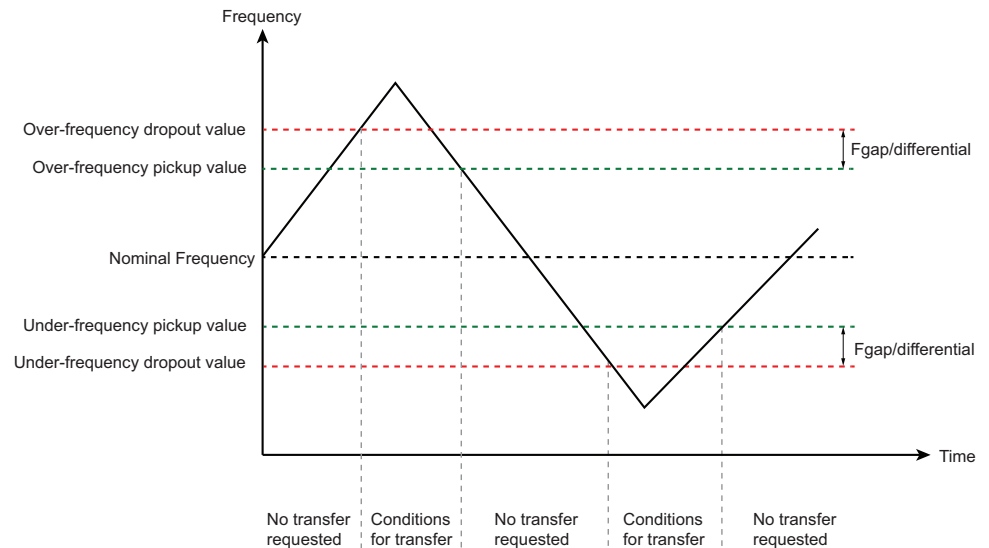

- Over frequency dropout value: Above this value, the frequency is out of range and transfer is initiated.
- Over frequency pickup value: When frequency goes back from over frequency, it is a condition to go back to normal situation.
- Under frequency dropout value: Below this value, the frequency is out of range and transfer is initiated.
- Under frequency pickup value: When frequency goes back from under frequency, it is a condition to go back to normal situation.

## Voltage and Frequency Setting

For TransferPacT Automatic: The rated voltage needs to be set using the dip switch.

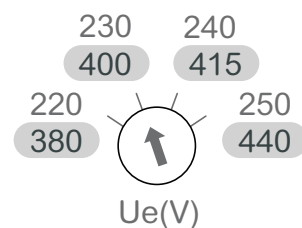

## Undervoltage Thresholds

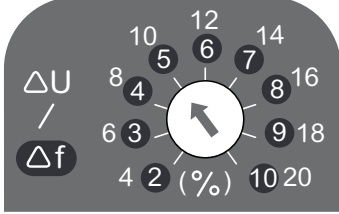
Field	Description
Default value	<ul style="list-style-type: none"> <li>Dropout: 10%</li> <li>Pickup: 20% of delta dropout</li> </ul>
Range	<p>Delta voltage ranges from 4%–20% of rated voltage: It could be 4–6–8–10–12–14–16–18–20%.</p> 
Vgap/differential	The differential between dropout and pickup on automatic HMI is fixed. The differential is set at 20% of the delta value.
Sequence of events	<ul style="list-style-type: none"> <li>When a sensor detects a voltage below the dropout set voltage for a period longer than the time delay, it will deem the voltage for out of range.</li> <li>When a sensor detects a voltage at or above the pickup point, it will deem the voltage as acceptable.</li> </ul>
Example of calculation on undervoltage of TransferPacT Automatic	<p>For example, <math>U_e = 400\text{ V}</math>, Dropout 10% = 40 V,                      Differential between dropout and pickup = <math>40\text{ V} * 20\% = 8\text{ V}</math>                      Undervoltage dropout is <math>400\text{ V} - 40\text{ V} = 360\text{ V}</math>                      Pickup = <math>360\text{ V} + 8\text{ V} = 368\text{ V}</math></p>

## Overvoltage Thresholds

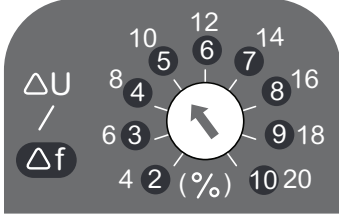
Field	Description
Default value	<ul style="list-style-type: none"> <li>Dropout: 10%</li> <li>Pickup: 20% of delta dropout</li> </ul>
Range	<p>Delta voltage ranges from 4%–20% of rated voltage: It could be 4–6–8–10–12–14–16–18–20%.</p>  <p>Default value: 10%</p>
Vgap/differential	The differential between dropout and pickup on automatic HMI is fixed. The differential is set at 20% of the delta value.
Sequence of events	<ul style="list-style-type: none"> <li>When a sensor detects a voltage above the dropout set voltage for a period longer than the time delay, it will deem the voltage for out of range.</li> <li>When a sensor detects a voltage at or below the pickup point, it will deem the voltage as applicable.</li> </ul>
Example of calculation on overvoltage of TransferPacT Automatic	<p>For example, <math>U_e = 400\text{ V}</math>, Dropout 10% = 40 V,                      Differential between dropout and pickup = <math>40\text{ V} * 20\% = 8\text{ V}</math>                      overvoltage dropout is <math>400\text{ V} + 40\text{ V} = 440\text{ V}</math>                      Pickup = <math>440\text{ V} - 8\text{ V} = 432\text{ V}</math></p>

### Under Frequency

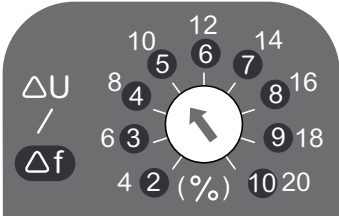
Field	Description
Default value	<ul style="list-style-type: none"> <li>• Dropout: 5%</li> <li>• Pickup: 20% of delta dropout</li> </ul>
Range	Delta frequency : 2% –10% of rated frequency and could be 2–3–4–5–6–7–8–9–10%.. 
Fgap/differential	The differential between dropout and pickup is fixed on automatic HMI and this gap is set at 20% of the delta.
Sequence of events	<ul style="list-style-type: none"> <li>• When a sensor detects a frequency below the set drop-out frequency for a period longer than the time delay, it deems the voltage is out of range.</li> <li>• When the sensor detects a frequency at or above the pick-up point, it deems the frequency as acceptable.</li> </ul>
Example of calculation on underfrequency of TransferPacT Automatic	For example, $F_e = 50 \text{ Hz}$ , Dropout 5%= 2.5 Hz, Differential between dropout and pickup= 2.5 Hz * 20%= 0.5Hz Underfrequency dropout is $50 \text{ Hz} - 2.5 \text{ Hz} = 47.5 \text{ Hz}$ Pickup = $47.5 \text{ Hz} + 0.5 \text{ Hz} = 48 \text{ Hz}$

### Over Frequency

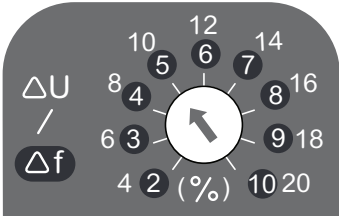
Field	Description
Default value	<ul style="list-style-type: none"> <li>• Dropout: 5%</li> <li>• Pickup: 20% of delta dropout</li> </ul>
Range	Delta Frequency : 2% -> 10% of rated : could be 2 – 3 – 4 – 5 – 6 – 7 – 8 – 9 – 10%.. 
Fgap/differential	The differential between dropout and pick up is fixed on automatic HMI and this differential is set at 20% of the delta value.
Sequence of events	<ul style="list-style-type: none"> <li>• When a sensor detects a frequency above the set drop-out frequency for a period longer than the time delay, it deems the voltage is out of range.</li> <li>• When the sensor detects a frequency at or below the pick-up point, it deems the frequency as acceptable.</li> </ul>
Example of calculation on overfrequency of TransferPacT Automatic	For example, $F_e = 50 \text{ Hz}$ , Dropout 5%= 2.5 Hz, Differential between dropout and pickup= 2.5 Hz * 20%= 0.5 Hz overfrequency dropout is $50 \text{ Hz} + 2.5 \text{ Hz} = 52.5 \text{ Hz}$ Pickup = $52.5 \text{ Hz} - 0.5 \text{ Hz} = 52 \text{ Hz}$

## Time Delay

-			Adjust/Range	Default
Symbol	Display	Definition	Automatic	Automatic
T2	Transfer Delay	Confirmation delay on source power failure	U-U: 0, 1, 2, 3, 5, 10, 20, 30, 60 s U-G: 5 s	U-U: 3 s U-G: 5 s
T4	Center-off Delay	OFF position delay	0, 5 s	0 s
T6	Re-transfer Delay	Confirmation delay to re-transfer on normal source	0, 1, 2, 3, 5, 10, 20, 30, 60 min	1 min
T7	Genset Start Delay	Delay to start Genset	U-U: 0s U-G: 0, 1, 2, 3, 5, 10, 20, 30, 60 s	U-U: 0 s U-G: 3 s
T8	Loadshed Delay	Delay to load shedding	N/A	0 s
T9	Genset cool delay	Genset cooling down delay	N/A	60 s
T10	Genset fail delay	Genset alarming failure detection time	N/A	300 s
T13	On load test delay	Time duration to run for test process on load.	N/A	0 s
T14	Off load test delay	Time duration to run for test process off load.	N/A	0 s

**NOTE:** When the test delay for TransferPacT automatic is requisite, contact Schneider Electric service team.

### T2: Transfer Delay

Field	Description
Applications	<ul style="list-style-type: none"> <li>Confirm connected source has failure.</li> <li>Measure the target source power (for example voltage and frequency) during the time delay.</li> <li>The delay shall detect both sources, the stop condition will be N recovered, or A source failed.</li> </ul>
Default values	5 s
Range	0, 1, 2, 3, 5, 10, 20, 30, 60 s
Adjust	Fixed value

### T4: Center-Off Delay

Field	Description
Applications	<ul style="list-style-type: none"> <li>Time delay applied to the center-off position O when Position I and Position II are transferring, it stops at Position O to protect inductive load.</li> <li>The delay is used for both process of transfer to N and A.</li> </ul>
Default values	0 s
Range	0 or 5 s
Adjust	Fixed value

## T6: Re-Transfer Delay

Field	Description
Applications	<ul style="list-style-type: none"> <li>Time delay applied when transferring from R to N in the Auto-Return mode. This delay is intended to measure the N and R during the delay.</li> <li>If N is abnormal, the timer will stop and the re-transfer is cancelled.</li> <li>If R is abnormal but Source N is normal, the switch will transfer immediately.</li> </ul>
Default values	1 min
Range	0, 1, 2, 3, 5, 10, 20, 30, 60 min
Adjust	Fixed value

## T7: Genset Start Delay

Field	Description
Applications	<ul style="list-style-type: none"> <li>Genset startup time delay (time delay before sent the signal to start Genset), available for U-G applications.</li> <li>The time delay only available when there is external power or select the Genset start module.</li> </ul>
Default values	3 s
Range	0,1, 2, 3, 5, 10, 20, 30, 60 s
Adjust	Fixed value

## T8: Loadshed Delay

Field	Description
Applications	<ul style="list-style-type: none"> <li>Load shedding delay, for U-U/U-G.</li> <li>Load shed: The alternate power (Genset) sometimes may not afford all loads. A signal from controller will shed some loads.</li> <li>Need customer to decide which load can be shed.</li> </ul>
Default values	0 s
Range	Not applicable
Adjust	Not applicable

## T9: Genset Cool Delay

Field	Description
Applications	<ul style="list-style-type: none"> <li>Delay between closing of N source and send the signal to stop the Genset.</li> <li>The propose is to keep the generator running at no load for some time before shutting / cooling down.</li> <li>When controller restarts, this time delay will be running also at U-G mode.</li> </ul> <p><b>NOTE:</b> To prevent any risk of Genset damage due to Genset stopping before the end of its starting process: Genset cooling time delay can only start after the end of Genset start time delay or after SII is within tolerances since source return time delay.</p>
Default values	60 s
Range	60 s
Adjust	Not applicable

## T10: Genset Fail Delay

Field	Description
Applications	<ul style="list-style-type: none"> <li>After sending the Genset start signal, controller will wait a time duration T10 until Genset is ready.</li> <li>The ATSE shall rise the Genset alarm, if genset is not started while T10 timer is ended (if enabled).</li> <li>The ATSE shall reset the Genset alarm, when the R source is in Range or when the N source is in Range.</li> <li>The time delay is only available when there is external power.</li> </ul>
Default values	<ul style="list-style-type: none"> <li>The default value is 300 s.</li> <li>The alarm can be enabled or disabled. Default as disabled.</li> </ul>
Range	300 s
Adjust	Not applicable

## T13: On Load Test Delay

Field	Description
Applications	Time duration for On load test process. It will rise the alarm if test is not finished in the time duration.
Default values	0 s
Range	0 s
Adjust	Not applicable

## T14: Off Load Test Delay

Field	Description
Applications	Time duration for off load test process. It will rise the Alarm if test is not finished in the time duration.
Default values	0 s
Range	0 s
Adjust	Not applicable

## Active Automatic HMI with LCD Display as Embedded HMI

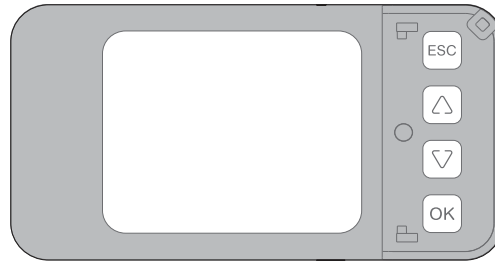

### Preferable Source Selection

TransferPacT Active Automatic provide an easy way to select the preferred source as normal source.

When the genset is at normal power and the utility is not so stable, make the selection as below:

For TransferPacT Active Automatic: To select the preferred source, go to **Source Configuration** page to make the selection.

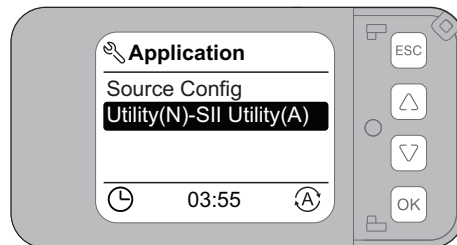

### Utility-Utility Operation

1. Detect the normal source contingency (Utility).
2. Transfer the load to replace alternate source (Utility) when normal source is out of tolerance.
3. Re-transfer to normal source when it is recovered if auto return mode is set.

### Utility-Generator Operation

1. Detect the normal source contingency (Utility).
2. Send out Genset start signal when normal source is out of tolerance.
3. Transfer the load to replace source (generator) when generator is ready.
4. Re-transfer to normal alternate source when it is recovered if auto return mode is set.
5. Send the Genset cool down signal after re-transfer to normal source.

## Status Description Based on Source Selection

### U-U Application

If U-U application is selected, then both Source I and Source II indicator (LED) will have two status:

- ON (OK)
- Blink (Out of Range)

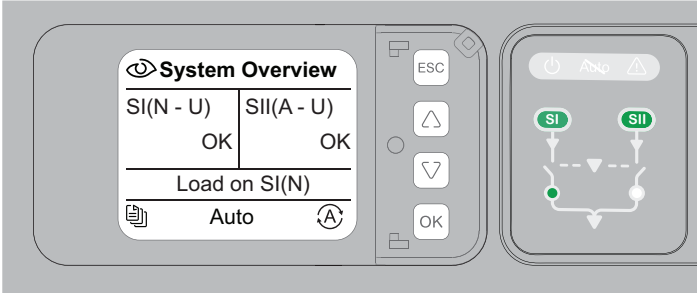
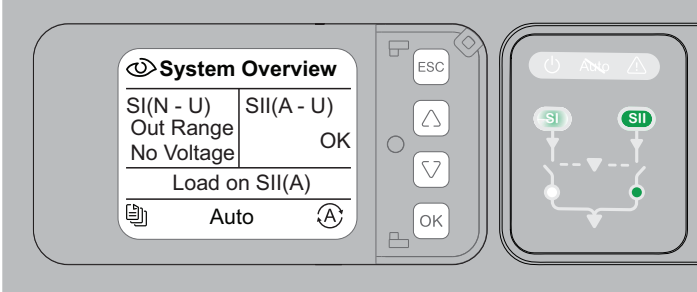
LED Indication	Status Description
LED ON (on both sources)	<p>Source present and in the range</p> <p>The display will show OK and LED be ON</p> 
LED Blinking (on N source)	<p>When there is power contingency. The display will show the SI status(Out Range) and current application mode.( vice versa for SII)</p> 

**NOTE:** in U-U mode, as long as one source is in range, the other source indicator will light on.

### U-G Application

If U-G application is selected, then Source II/Source I (the one connect to Genset) will have three status:

- ON (OK)
- Blink (Out of Range)
- OFF if the Genset start signal (need accessory TPCDIO17) is not active

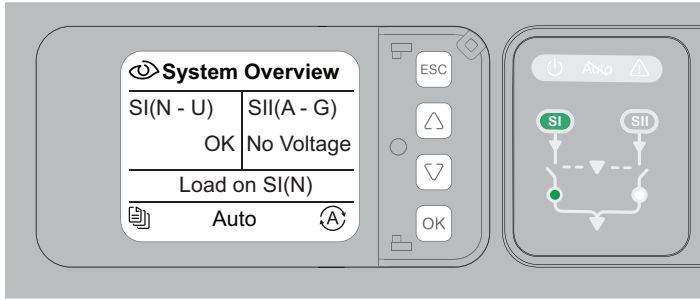
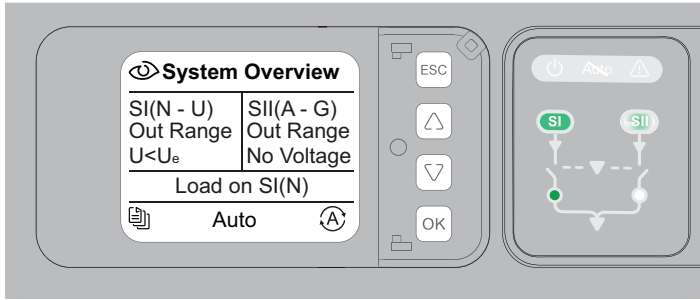
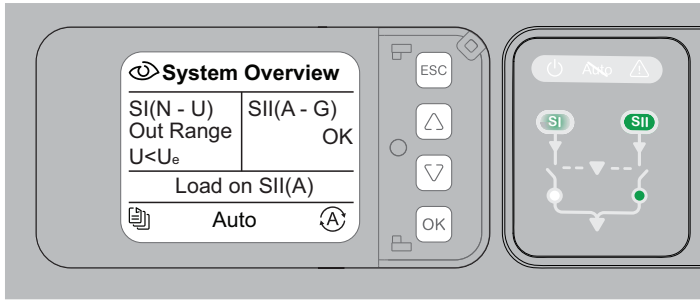
LED Indication	Status Description
<p>LED OFF (on Source A)</p> <p>LED ON (on Source N)</p>	<p>Genset (for example, SII) start signal is not active</p> <p>The display will show OFF</p> 
<p>LED Blinking (on Source A and Source N)</p>	<p>Genset(SII, e.g.)start signal is sent out, genset is activating but not ready.</p> <p>The display will show Out Range</p> 
<p>LED ON (on both sources)</p> <p>LED Blinking (on both Source A)</p>	<p>Genset is running and in range, load is on SII.</p> <p>The display will show ON on SI and ON on SII</p> 

The table below explains the status and their occurrences:

Status	Occurrences
OFF	The status is OFF, when the detected source is genset and the gen start signal is not sent.
OK	The status is OK, when all the enabled detection related to this source are in range.
Out Range	The status is Out Range, when any enabled detection related to this source are out of range.

The number of possible values depends on the source setting and transfer status:

If...	Then...
the source is a Utility source	two possible values are OK and Out Range.
the source is a Genset source	three possible values are OK, Out Range and OFF when genset start signal not sent, out of range when genset is starting or enabled detection related to genset is not in range.

## Transfer Condition

The following are the auto-transfer conditions:

- **Voltage deviation:** Controller monitors two sources, and uses over-voltages and under-voltages thresholds as conditions of source transfer.
- **Frequency deviation:** Controller monitors two sources, and uses over-frequency and under-frequency thresholds as conditions of source transfer.
- **Phase rotation:** Controller detect two sources phase sequence as the condition of source transfer (\*Active Automatic HMI only).

## Threshold

Description	Settings	Default setting (% of nominal)	Range	Adjustment
Normal/Alternate source voltage	Under voltage Dropout	85%	70%-95%	Step of 1%
	Under voltage Pickup	90%	85%-100%	Step of 1%
	Over voltage Dropout	110%	105%-135%	Step of 1%
	Over voltage Pickup	105%	100%-115%	Step of 1%
	Minimum differential between Dropout and pickup	2%	--	
Normal/Alternate source frequency	Under Frequency Dropout	96%	80%-98%	Step of 0.5%
	Under Frequency Pickup	97%	85%-100%	Step of 0.5%
	Over Frequency Dropout	102%	101%-120%	Step of 0.5%
	Over Frequency Pickup	101%	100%-115%	Step of 0.5%
	Minimum differential between Dropout and pickup	0.50%	--	
Voltage unbalance		Disabled	2%-30%	
Phase rotation		Enabled		
Neutral wrong connection		Enabled		
Neutral lost		Disabled		unbalance rate

The accuracy of voltage sensing is 1%.

The accuracy of frequency sensing is 0.1%.

## Voltage Dropout and Pickup

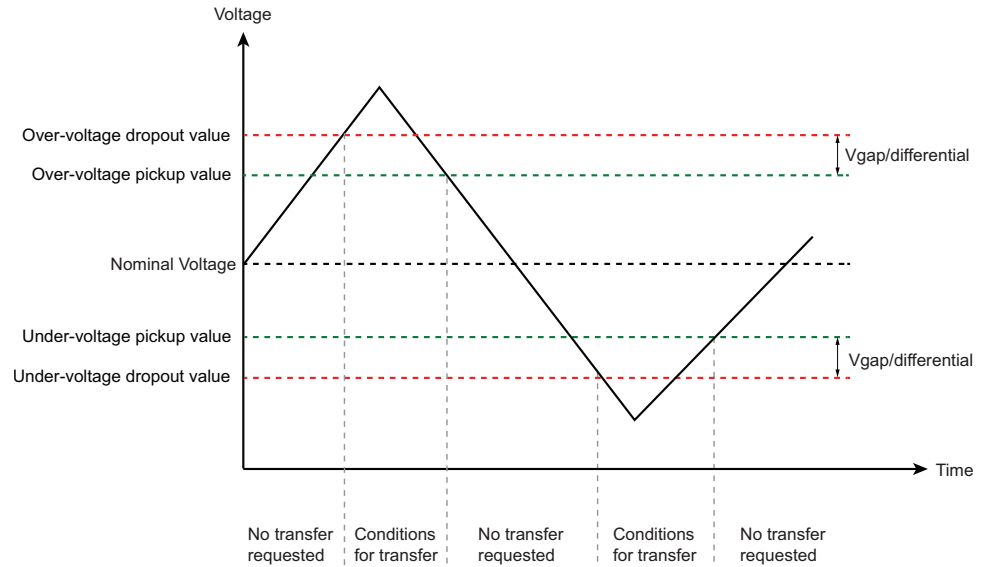

- Over voltage dropout value: Above this value, the voltage is out of range and transfer is initiated.
- Over voltage pickup value: When voltage goes back from over frequency, it is a condition to go back to normal situation.
- Under voltage dropout value: Below this value, the voltage is out of range and transfer is initiated.
- Under voltage pickup value: When voltage goes back from under voltage, it is a condition to go back to normal situation.

## Frequency Dropout and Pickup

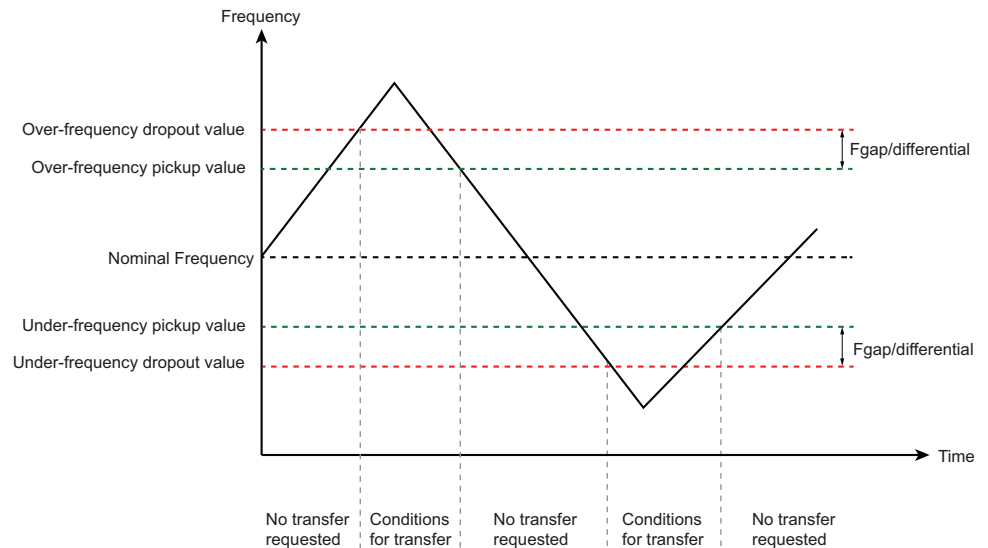

- Over frequency dropout value: Above this value, the frequency is out of range and transfer is initiated.
- Over frequency pickup value: When frequency goes back from over frequency, it is a condition to go back to normal situation.
- Under frequency dropout value: Below this value, the frequency is out of range and transfer is initiated.
- Under frequency pickup value: When frequency goes back from under frequency, it is a condition to go back to normal situation.

## Voltage and Frequency Setting

For TransferPacT Active Automatic: The rated voltage needs to be set using the LCD display.

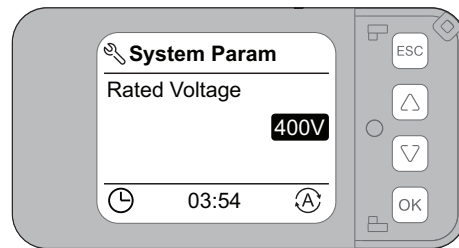

## Undervoltage Thresholds

Field	Description
Default value	<ul style="list-style-type: none"> <li>Dropout: 85% of the rated voltage.</li> <li>Pickup: 90% of the rated voltage.</li> </ul>
Range	<ul style="list-style-type: none"> <li>Range for falling voltage (dropout) is 70%–95% of the rated voltage.</li> <li>Range for return voltage (pickup) is 85%–100% of the rated voltage.</li> </ul>
Adjustable	The adjustable step for an undervoltage threshold is 1%.
Vgap/differential	<ul style="list-style-type: none"> <li>The differential between dropout and pickup is equal to 2% of rated voltage.</li> </ul>
On LCD display	<ul style="list-style-type: none"> <li>If minimum 2% differential of rated voltage rule is broken during dropout setting, the pickup value will be modified dynamically (pickup = dropout + 2%) to keep the rule.</li> </ul>
On Modbus	Modbus register write: The dropout value is always accepted. The pickup value will be modified to a value (pickup = dropout + 2%) when the pickup value does not comply the minimum differential.
Sequence of events	<ul style="list-style-type: none"> <li>When a sensor detects a voltage below the dropout set voltage for a period longer than the time delay, it will deem the voltage for out of range.</li> <li>When a sensor detects a voltage at or above the pickup point, it will deem the voltage as acceptable.</li> </ul>

## Overvoltage Thresholds

Field	Description
Default value	<ul style="list-style-type: none"> <li>Dropout: 110% of the rated voltage.</li> <li>Pickup: 105% of the rated voltage.</li> </ul>
Range	<ul style="list-style-type: none"> <li>Range for falling voltage (dropout) is 105%–135% of the rated voltage.</li> <li>Range for return voltage (pickup) is 100%–105% of the rated voltage.</li> </ul>
Adjustable	The adjustable step for an overvoltage threshold is 1%.
Vgap/differential	<ul style="list-style-type: none"> <li>The default differential between dropout and pickup is equal to 2% of rated voltage.</li> </ul>
On LCD display	<ul style="list-style-type: none"> <li>If minimum 2% differential of rated voltage in default rule is broken during dropout setting, the pickup value will be modified (pickup=dropout–2%) to keep the rule.</li> </ul>
On Modbus	The dropout value is always accepted. The pick-up value will be modified to a value (pickup=dropout–2%) when the pick-up value does not comply the minimum differential.
Sequence of events	<ul style="list-style-type: none"> <li>When a sensor detects a voltage above the dropout set voltage, for a period longer than the time delay, it will deem the voltage for out of range.</li> <li>When a sensor detects a voltage at or below the pickup voltage, it will deem the voltage as acceptable.</li> </ul>

## Under Frequency

Field	Description
Default value	<ul style="list-style-type: none"> <li>Dropout: 95% of the rated frequency.</li> <li>Pickup: 97% of the rated frequency.</li> </ul>
Range	<ul style="list-style-type: none"> <li>Range for falling voltage (dropout) is 80%–95% of rated voltage.</li> <li>Range for return voltage (pickup) is 85%–100% of rated voltage.</li> </ul>
Adjustable	The adjustable step for under frequency threshold is 0.5%.
Fgap/differential	<ul style="list-style-type: none"> <li>The default differential between dropout and pickup is equal to 0.5% of rated frequency.</li> </ul>
On LCD display	<ul style="list-style-type: none"> <li>If minimum differential rule is broken during dropout setting, the pickup value will be modified (pickup = dropout – 0.5% ) to keep the rule.</li> </ul>
On Modbus	Dropout value is always accepted, if the pickup value doesn't comply the minimum differential, the pickup value will be modified to value (pickup = dropout – 0.5%).
Sequence of events	<ul style="list-style-type: none"> <li>When a sensor detects a frequency below the set drop-out frequency for a period longer than the time delay, it deems the voltage is out of range.</li> <li>When the sensor detects a frequency at or above the pick-up point, it deems the frequency as acceptable.</li> </ul>

## Over Frequency

Field	Description
Default value	<ul style="list-style-type: none"> <li>Dropout: 105% of the rated frequency.</li> <li>Pickup: 101% of the rated frequency.</li> </ul>
Range	<ul style="list-style-type: none"> <li>The over frequency sensing range for a falling voltage (dropout) is 101%–120% of rated voltage.</li> <li>The over frequency sensing range for a return voltage (pickup) is 100%–115% of rated voltage.</li> </ul>
Adjustable	The adjustable step for over frequency threshold is 0.5%.
Fgap/differential	<ul style="list-style-type: none"> <li>The default differential between dropout and pickup = 0.5% of rated frequency.</li> </ul>
On LCD	<ul style="list-style-type: none"> <li>If minimum differential (0.5% of rated in default) rule is broken during dropout setting, the pickup value will be modified (pickup = dropout – 0.5% ) to keep the rule.</li> </ul>
On Modbus	Dropout value is always accepted, if the pickup value do not comply the minimum gap, the pickup value will be modified to value (pickup = dropout – 0.5%).
Sequence of events	<ul style="list-style-type: none"> <li>When a sensor detects a frequency above the set dropout frequency for a period longer than the time delay, it deems the voltage is out of range.</li> <li>When the sensor detects a frequency at or below the pickup point, it deems the frequency as acceptable.</li> </ul>

## Voltage Unbalance (Three Phase Unbalance)

Field	Description
Applications	<p>The single-phase loading causes a voltage unbalance. When the maximum deviation from average voltage is greater than a user-specific value of the average voltage, the sensor indicates a failure.</p> <p>The voltage unbalance is only for TransferPacT Active Automatic.</p>
Default value	<ul style="list-style-type: none"> <li>The voltage unbalance feature can be enabled or disabled. By default, this feature is disabled.</li> <li>When there is a voltage unbalance after enabling the sensor, it will raise an alarm and transfer is initiated.</li> <li>The default value for voltage unbalance is disabled</li> </ul>
Range	The adjustment range for voltage unbalance is between 2%–30%.

## Phase Rotation

Field	Description
Applications	<p>This feature monitors the phase rotation of the source opposite from the connected source. In order to check phase rotation, both voltage sources must be applied.</p> <p>This feature is applicable for 4-pole products.</p> <p>It protects against equipment damage by preventing transfer to a source that is out of phase. This occurs during new installations or after storm damage or generator rewiring (U-G).</p>
Default value	This feature could be enabled or disabled. By default, it is enabled.
Detection Criteria	When the power source is normal, phase angle differences is to be checked (PhaseA – PhaseB/PhaseB – Phase A). It should be $120^\circ/240^\circ \pm 5^\circ$ .

## Transfer Count

The TransferPacT controller can count successful and failure transfer counts separately.

**NOTE:** Only the TransferPacT Active ATSE will display the transfer count.

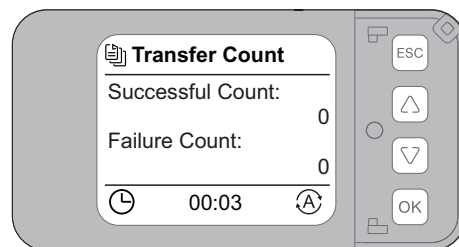

## Neutral Wrong Connections Detections

Field	Description
Applications	<ul style="list-style-type: none"> <li>An alarm is raised when this function is enabled to prevent wrong connection of neutral cable.</li> <li>When this function is enabled and neutral wrong is detected, an alarm will be shown to the user on HMI (only Active Automatic HMI).</li> </ul>
Default value	This feature could be enabled or disabled. By default, it is disabled.
Detection criteria	<p>Consider only the normal power source, and conclude if neutral wrong according to check Van, Vbn, Vcn, Vab, Vbc, Vca.</p> <p><b>Example:</b> Consider the neutral wrong when the nominal power source is 380 V. For 380 V system, line voltage should be 380 V and phase voltage should be 220 V.</p>

## Neutral Loss

Field	Description
Applications	<ul style="list-style-type: none"> <li>A warning is raised when this function is enabled to prevent wrong connection, miss connection or disconnection caused by interior or exterior impacts of neutral cable.</li> <li>Only available for TransferPacT Active Automatic.</li> </ul>
Default value	<p>This feature could be enabled or disabled. By default, it is disabled.</p> <p>The LED of source will blink to warn when there is neutral loss after the sensor is enabled.</p>
Detection criteria	When the load is connected to the power source and live, the unbalanced loads are detected.

## Time Delay

-			Adjust	Range	Default
Symbol	Display	Definition	Active automatic	Active automatic	Active automatic
T2	Transfer Delay	Confirmation delay on source power failure	0.1 s from 0-1 s. 1 s when >1 s.	0-1800 s	3 s
T4	Center-off Delay	OFF position delay	1 s	0-30 s	0 s
T6	Re-transfer Delay	Confirmation delay to re-transfer on normal source	1 s	0-3600 s	60 s
T7	Genset Start Delay	Delay to start Genset	1 s	0-120 s	3 s
T8	Loadshed Delay	Delay to load shedding	1 s	0-15 s	0 s
T9	Genset cool delay	Genset cooling down delay	1 s	0-3600 s	60 s
T10	Genset fail delay	Genset alarming failure detection time	1 s	15–300 s	300 s
T13	On load test delay	Time duration to run for test process on load.	1 s	Unlimited: 0 s Limited: 1-1800 s	Unlimited: 0 s Limited: 30 s
T14	Off load test delay	Time duration to run for test process off load.	1 s	Unlimited: 0 s Limited: 1-1800 s	Unlimited: 0 s Limited: 30 s

### T2: Transfer Delay

Field	Description
Applications	<ul style="list-style-type: none"> <li>Confirm connected source has failure.</li> <li>Measure the target source power (for example voltage and frequency) during the time delay.</li> <li>The delay shall detect both sources, the stop condition will be N recovered, or A source failed.</li> </ul>
Default values	3 s
Range	0–1800 s
Adjust	Step of 0.1 s from 0-1 s. 1 s when >1 s.

### T4: Center-Off Delay

Field	Description
Applications	<ul style="list-style-type: none"> <li>Time delay applied to the center-off position O when Position I and Position II are transferring, it stops at Position O to protect inductive load.</li> <li>The delay is used for both process of transfer to N and A.</li> </ul>
Default values	0 s
Range	0–30 s
Adjust	Step of 1 s

## T6: Re-Transfer Delay

Field	Description
Applications	<ul style="list-style-type: none"> <li>Time delay applied when transferring from R to N in the Auto-Return mode. This delay is intended to measure the N and R during the delay.</li> <li>If N is abnormal, the timer will stop and the re-transfer is cancelled.</li> <li>If R is abnormal but Source N is normal, the switch will transfer immediately.</li> </ul>
Default values	60 s
Range	0–3600 s
Adjust	Step of 1 s

## T7: Genset Start Delay

Field	Description
Applications	<ul style="list-style-type: none"> <li>Genset startup time delay (time delay before sent the signal to start Genset), available for U-G applications.</li> <li>The time delay only available when there is external power or select the Genset start module.</li> </ul>
Default values	3 s
Range	0–120 s
Adjust	Step of 1 s

## T8: Loadshed Delay

Field	Description
Applications	<ul style="list-style-type: none"> <li>Load shedding delay, for U-U/U-G.</li> <li>Load shed: The alternate power (Genset) sometimes may not afford all loads. A signal from controller will shed some loads.</li> <li>Need customer to decide which load can be shed.</li> </ul>
Default values	0 s
Range	0–15 s
Adjust	Step of 1 s

## T9: Genset Cool Delay

Field	Description
Applications	<ul style="list-style-type: none"> <li>Delay between closing of N source and send the signal to stop the Genset.</li> <li>The propose is to keep the generator running at no load for some time before shutting / cooling down.</li> <li>When controller restarts, this time delay will be running also at U-G mode.</li> </ul> <p><b>NOTE:</b> To prevent any risk of Genset damage due to Genset stopping before the end of its starting process: Genset cooling time delay can only start after the end of Genset start time delay or after SII is within tolerances since source return time delay.</p>
Default values	60 s
Range	0–3600 s
Adjust	Step of 1 s

## T10: Genset Fail Delay

Field	Description
Applications	<ul style="list-style-type: none"> <li>After sending the Genset start signal, controller will wait a time duration T10 until Genset is ready.</li> <li>The ATSE shall rise the Genset alarm, if genset is not started while T10 timer is ended (if enabled).</li> <li>The ATSE shall reset the Genset alarm, when the R source is in Range or when the N source is in Range.</li> <li>The time delay is only available when there is external power.</li> </ul>
Default values	<ul style="list-style-type: none"> <li>The default value is 300 s.</li> <li>The alarm can be enabled or disabled. Default as disabled.</li> </ul>
Range	15–300 s
Adjust	Step of 1 s

## T13: On Load Test Delay

Field	Description
Applications	Time duration for On load test process. It will rise the alarm if test is not finished in the time duration.
Default values	<ul style="list-style-type: none"> <li>Default as unlimited(0 s), has to manual stop test procedure.</li> <li>If select limited, default as 30 s.</li> </ul>
Range	1–1800 s
Adjust	Step of 1 s

## T14: Off Load Test Delay

Field	Description
Applications	Time duration for off load test process. It will rise the Alarm if test is not finished in the time duration.
Default values	<ul style="list-style-type: none"> <li>Default as unlimited(0 s), has to manual stop test procedure.</li> <li>If select limited, default as 30 s.</li> </ul>
Range	1–1800 s
Adjust	Step of 1 s

# Control Mode

## Overview

The control mode is used to operate TSE in different applications. The TransferPacT Active ATSE contains every function needed with nine control modes:

- Auto mode
- Test mode
- Communication transfer mode
- Voluntary transfer mode
- Local control mode
- Transfer inhibit mode
- Fire protection mode
- Force to off mode
- Handle transfer mode

The TransferPacT Automatic contains below control modes:

- Auto mode
- Test mode
- Voluntary transfer mode
- Transfer inhibit mode
- Fire protection mode
- Force to off mode
- Handle transfer mode

## Priority of Control Mode

Type of mode	Handle	Force	Fire	Inhibit	Local	Voluntary	Comm	Test	Auto
Handle transfer mode	-								
Force to off mode	x	-							
Fire protection mode	x	x	-						
Transfer inhibit mode	x	x	x	-					
Local control mode	x	x	x	x	-				
Voluntary transfer mode	x	x	x	x	x	-			
Comm transfer mode	x	x	x	x	x	x	-		
Test mode	x	x	x	x	x	x	x	-	
Auto mode	x	x	x	x	x	x	x	x	-
"- " = No caution "  " = Interrupt "X" = Ignore									

## Auto Mode

ATSE works on auto control mode normally. The controller monitors the real time values of both the sources. When there is source contingency, the transfer action will be energized to keep the power continuity for critical source.

Auto mode is supports U-G or U-U applications.

**NOTE:** Auto transfer will not be active, if transfer action damages driving system (for example, both sources are out of range, TSE refuses to transfer).

There are two types of auto control mode:

- Auto-return
- Non-return

Naming	Condition for stay on A situation return	
Power source definition	N available A available	N available A unavailable
Auto-return	Switch to N	Switch to N
Non-return	Stay at A	Switch to N

## Auto-Return

The auto-return has two modes as below:

- When the voltage on the N source exceeds the threshold (overvoltage, undervoltage, over frequency, under frequency) or does not exist, the ATSE will be transferred to the A source.
- When the voltage on the N source is within the threshold range, the ATSE will be transferred to N source.

The process of transfer can be controlled by time delay.

## Transfer Process for Auto-Return U-U Application

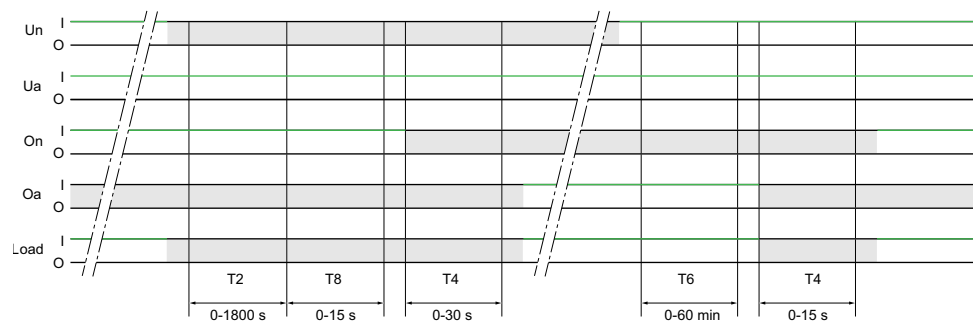

Symbols	Description
Un	Source I
Ua	Source II
On	Contact close at N source
Oa	Contact close at A source
Load	Load status
T2	Transfer delay
T8	Loadshed delay
T4	Center-off delay

Symbols	Description
T6	Re-Transfer delay
<b>Key</b> O: OFF (circuit open) I: ON (circuit closed) ■: No power	

## Transfer Logic for Auto-Return U-U Application

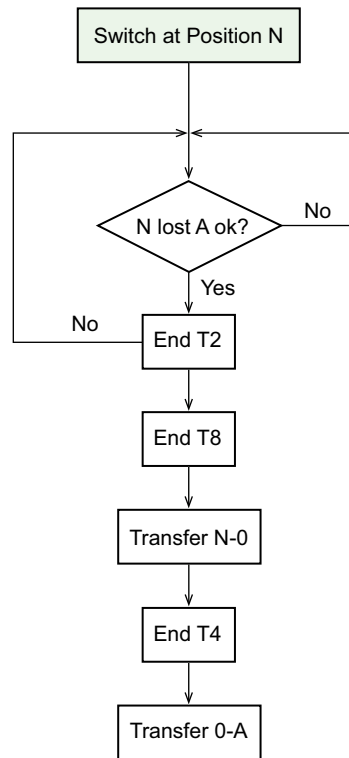

T2 will reset if N becomes available or A becomes unavailable.

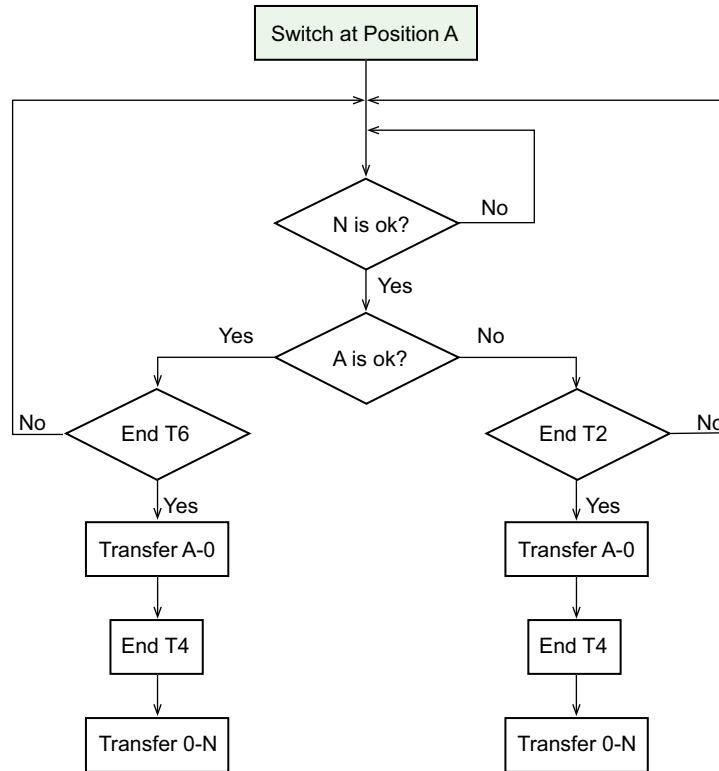

- T2 will reset if N becomes unavailable
- T6 Reset if N becomes unavailable
- During T6, if A is not available it will keep to count T6 if the rest time of T6 is shorter than T2. Other wise it goes to T2
- Retransfer principles when source A is ok, retransfer goes to T6 when source A is not ok and when source A is utility, retransfer goes to T2. If source A is Genset and not ok, retransfer delay is 0.

### Transfer Process for U-G Application

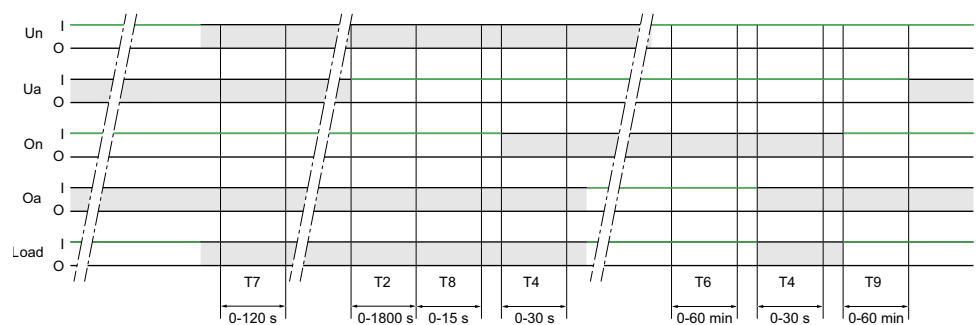

Symbols	Description
Un	Source I
Ua	Source II
On	Contact close at N source
Oa	Contact close at A source
Load	Load status
T7	Genset start delay
T2	Transfer delay
T8	Loadshed delay
T4	Center-off delay
T6	Re-Transfer delay

Symbols	Description
T9	Genset cool delay
<b>Key</b> O: OFF (circuit open) I: ON (circuit closed) ■: No power	

## Transfer Logic for U-G Application

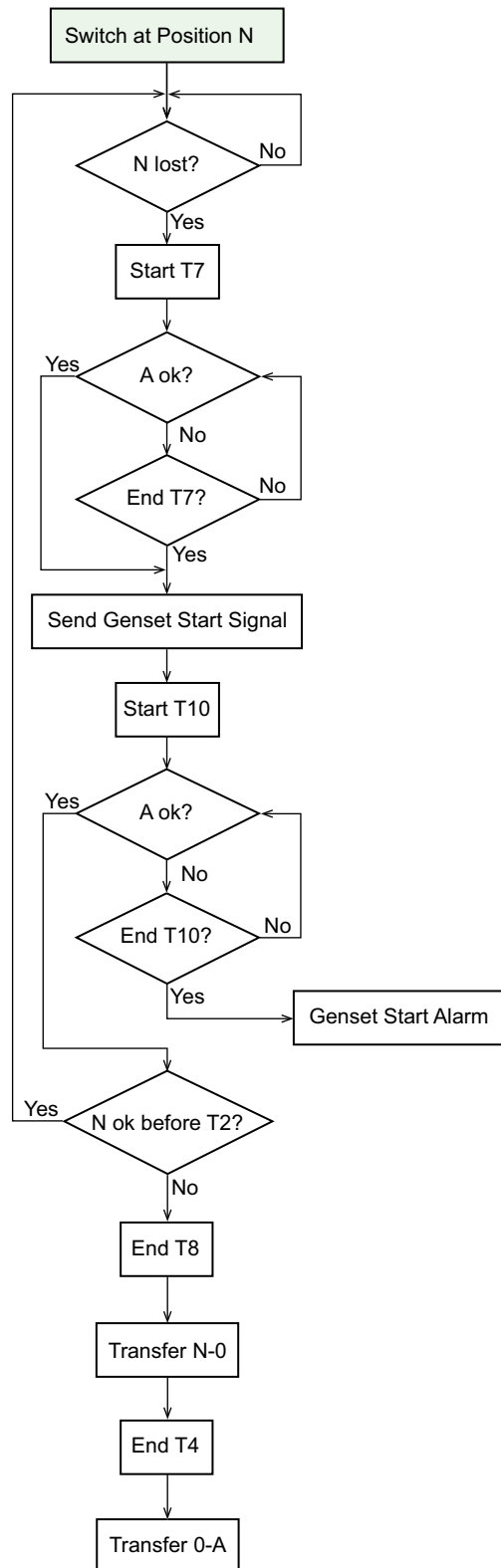

### Transfer Logic

- T2 will reset if N becomes unavailable
- If disable Genset Start Fail Warning, T10 will not be counted
- The whole transfer will be canceled if N becomes available during T7

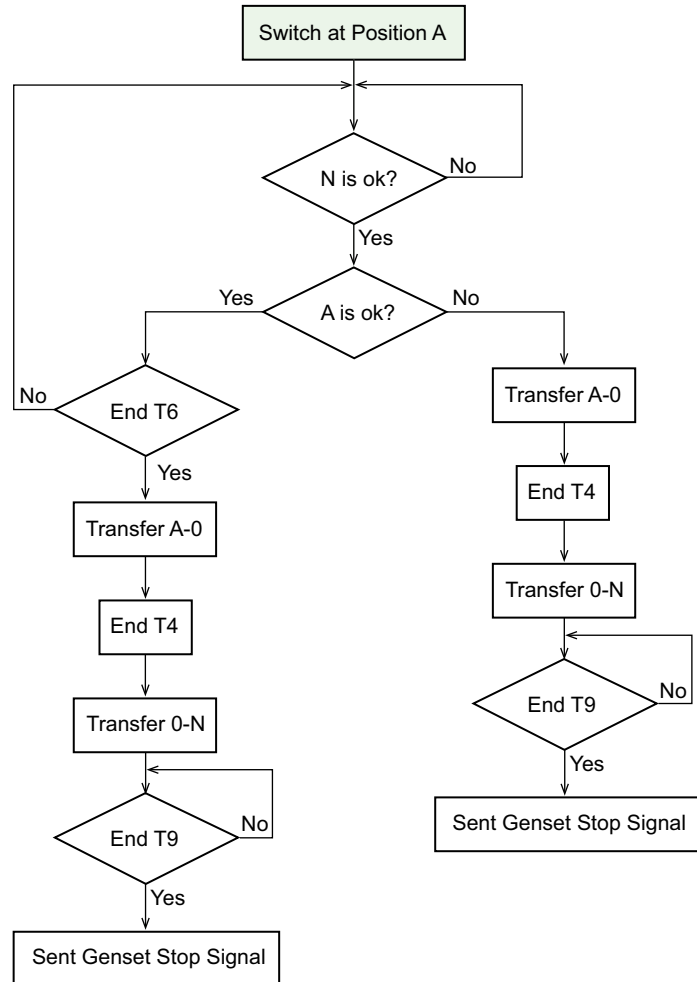

### Retransfer Logic

- T2 will reset if N becomes unavailable
- T6 Reset if N becomes unavailable
- During T6, if A is not available it will keep to count T6 if the rest time of T6 is shorter than T2. Other wise it goes to T2

## Non-Return

In the non-return mode, after auto transfer to replacement, the ATSE will be connected to the alternate source until:

- An external order is given to transfer back to N source.
- The alternate source is out of range. In such case, the ATSE controller will transfer back to the N source to maintain power availability.

There will be only one time power off, when there is normal power outage.

## Transfer Process of Non-return for U-U Application

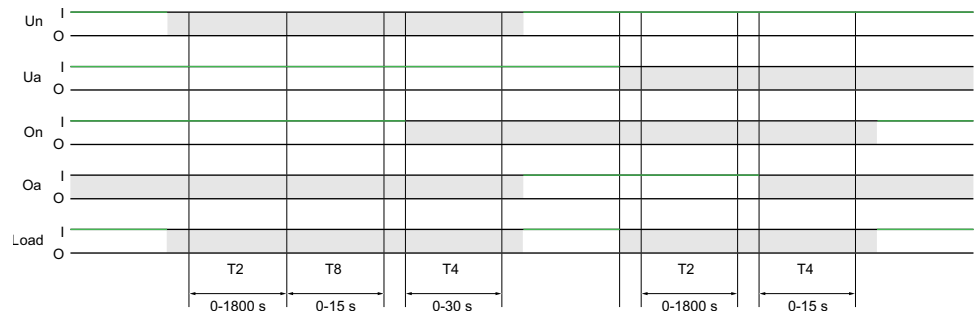

Symbols	Description
Un	Source I
Ua	Source II
On	Contact close at N source
Oa	Contact close at A source
Load	Load status
T2	Transfer delay
T8	Loadshed delay
T4	Center-off delay
<b>Key</b>	
O: OFF (circuit open)	
I: ON (circuit closed)	
■: No power	

## Logic of Non-return for U-U Application

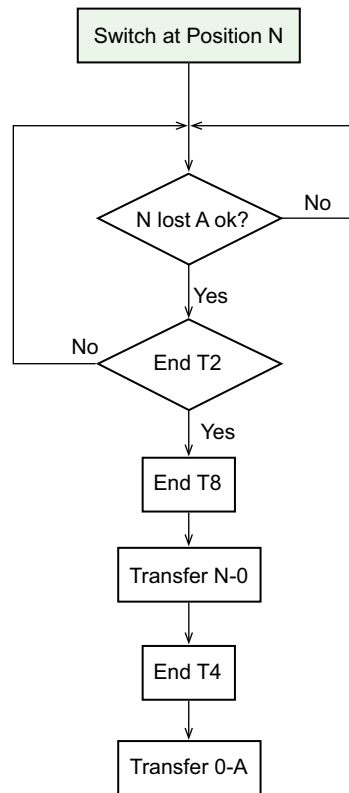

### Transfer Logic

T2 will reset if N becomes available or A becomes unavailable

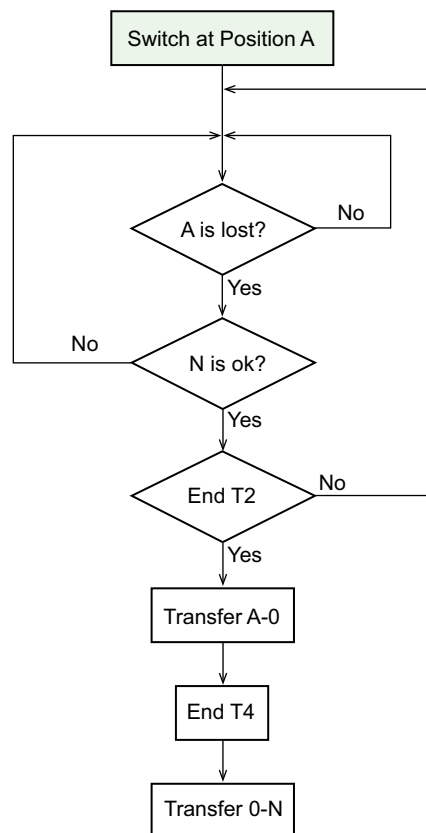

### Retransfer Logic

T2 will reset if N becomes unavailable

## Transfer Process of Non-return for U-G Application

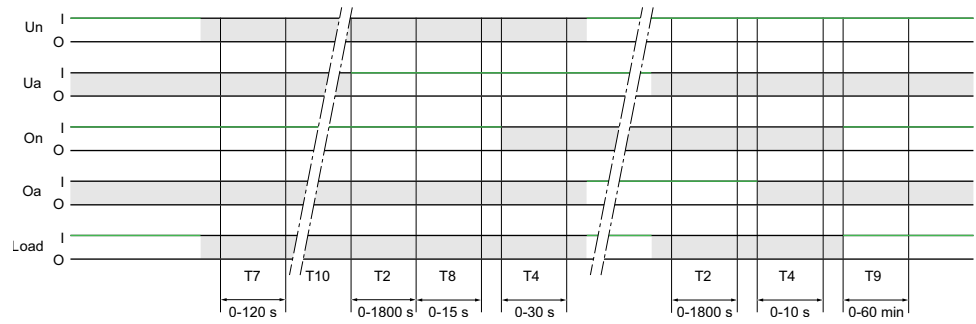

Symbols	Description
Un	Source I
Ua	Source II
On	Contact close at N source
Oa	Contact close at A source
Load	Load status
T7	Genset start delay
T2	Transfer delay
T8	Loadshed delay
T4	Center-off delay
T9	Genset cool delay
<b>Key</b>	
O: OFF (circuit open)	
I: ON (circuit closed)	
■: No power	

## Logic of Non-return for U-G Application

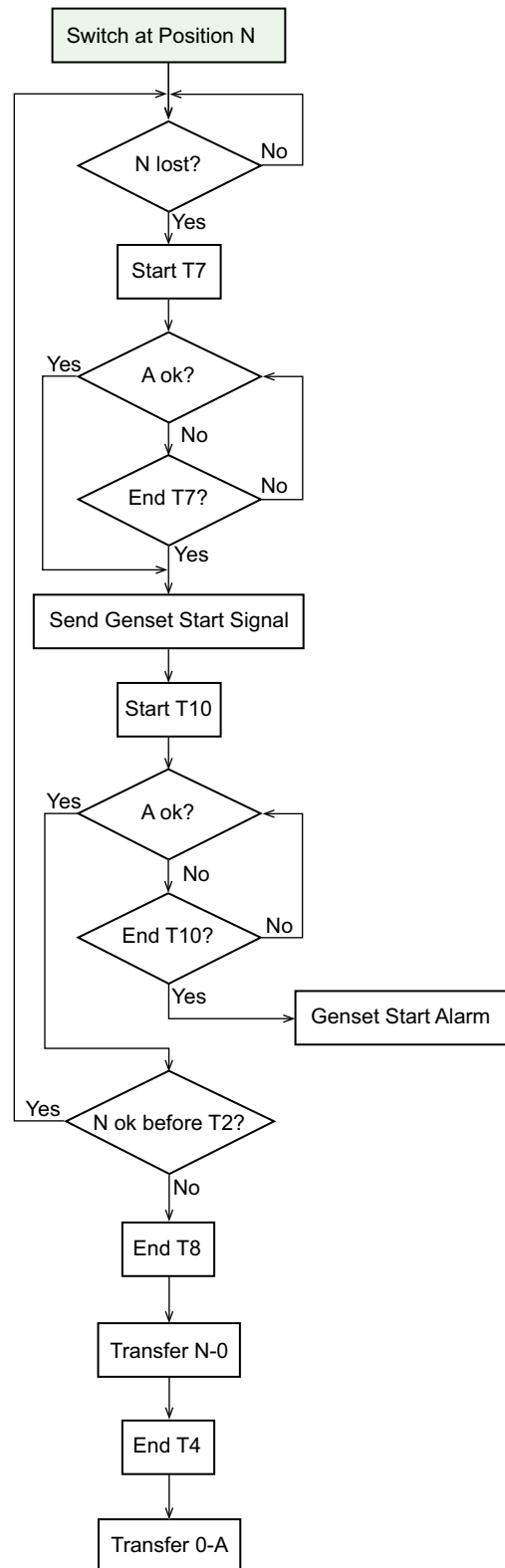

### Transfer Logic

- T2 will reset if N becomes available or A becomes unavailable
- If disable Genset Start Fail Warning, T10 will not be counted

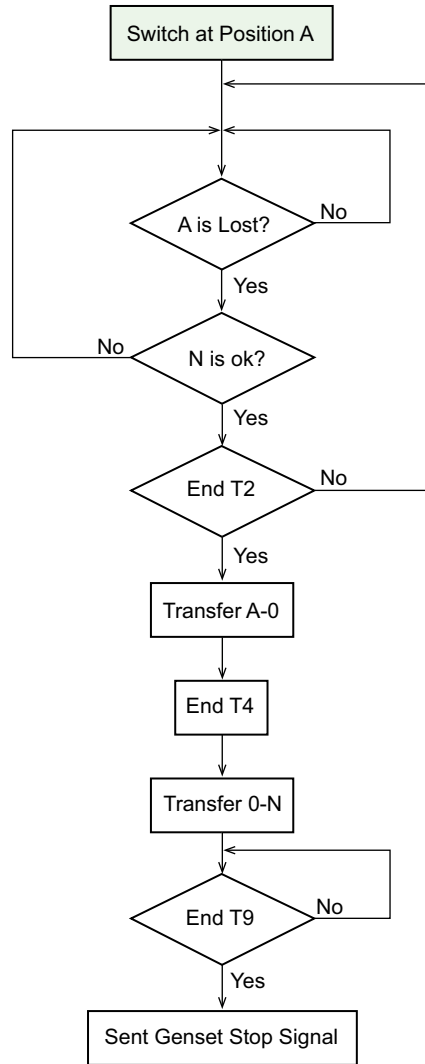

**Retransfer Logic**

T2 will reset if N becomes unavailable

# Communication Control

## Overview

The communication control function allows TSE to transfer or test through Modbus communication. The switch can refuse to respond if the action will damage the driving system. It cannot transfer to unavailable source either.

The communication control function can be enabled/disabled through Active Automatic HMI (only available for TransferPacT Active Automatic transfer switch equipment).

To use the communication control successfully, at least one Modbus module should be installed and activated.

**NOTE:** Communication control is OFF by default. Follow the instructions below to enable communication control.

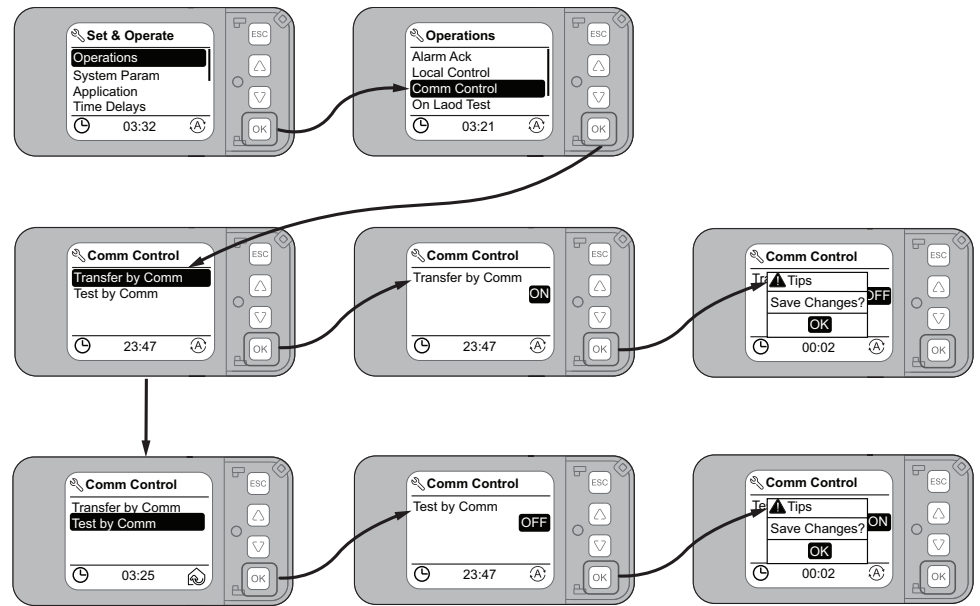

## Transfer by Communication

### Transfer Logic Overview

Transfer by communication support the following four commands:

- Comm to Normal Source
- Comm to Alternate Source
- Comm to OFF
- Comm to Exit

The command is sent through PC - Modbus. Comm to N/A is equivalent to the voluntary transfer mode on the transfer result. Comm to OFF is equivalent to local control to off in Local Control Mode, but different to Force to Off Mode. The ATSE will transfer to off after receiving the command without any time delay.

When more than one Modbus modules are installed, the ATSE will only response to the module which send the command first. It will not response to any command from other modules until the first module send the Exit command.

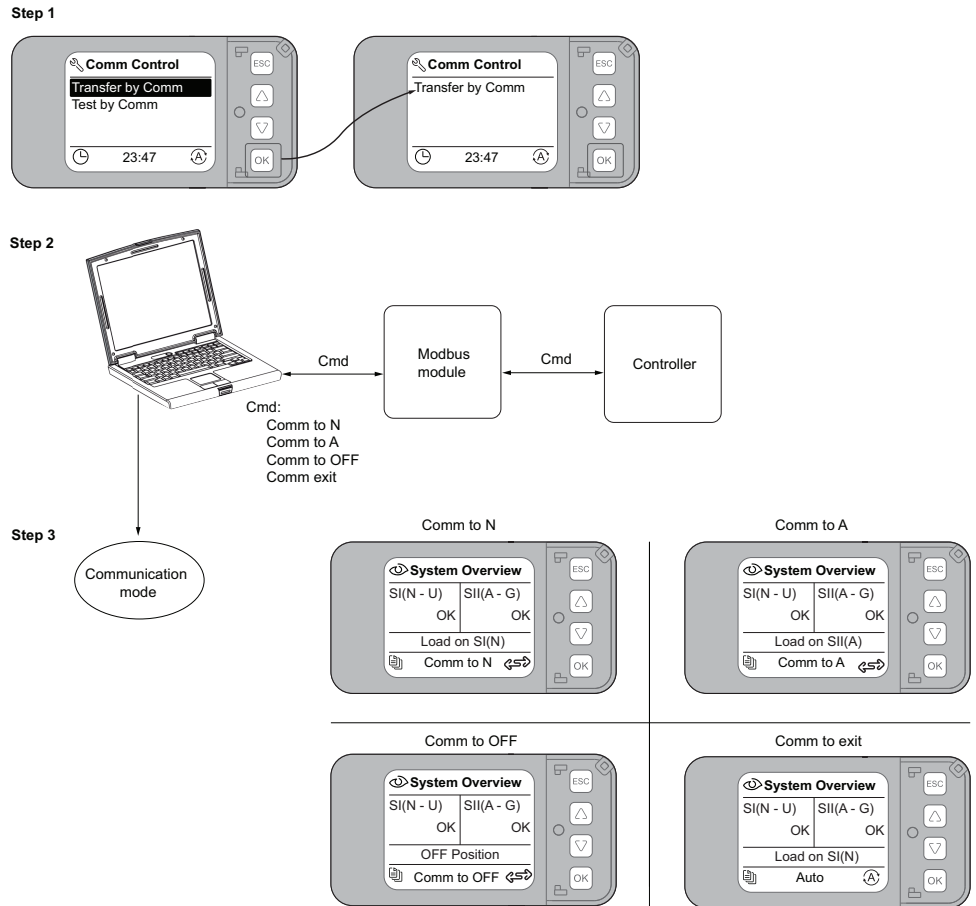

### Exit Communication Control Mode

There are three ways to exit communication control mode:

- The Modbus master device send exit command to the active Modbus module installed on ATSE.
- Turn off Transfer by Comm from active automatic HMI.
- The active Modbus module is offline.

### Transfer Logic of Communication to A (U-U Application)

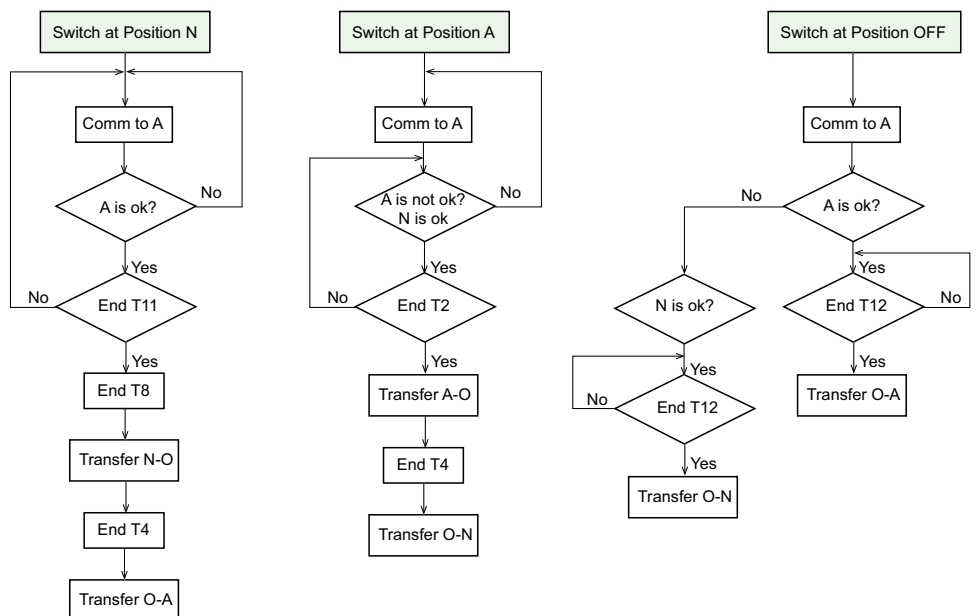

T11 is internal fixed time delay.

### Transfer Logic of Communication to N (U-U Application)

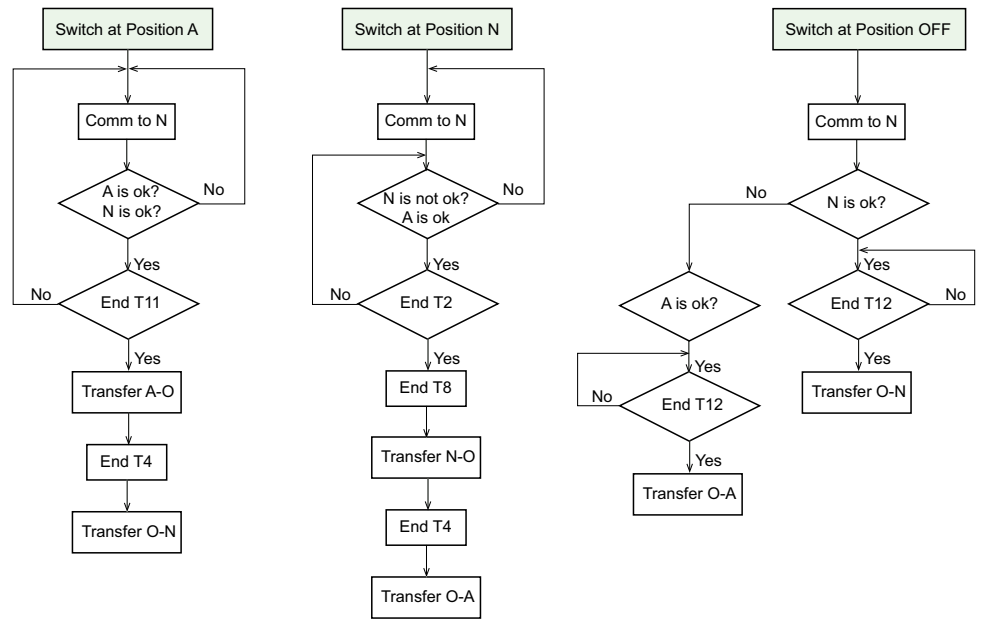

T11 is internal fixed time delay.

### Transfer Logic of Communication to A (U-G Application)

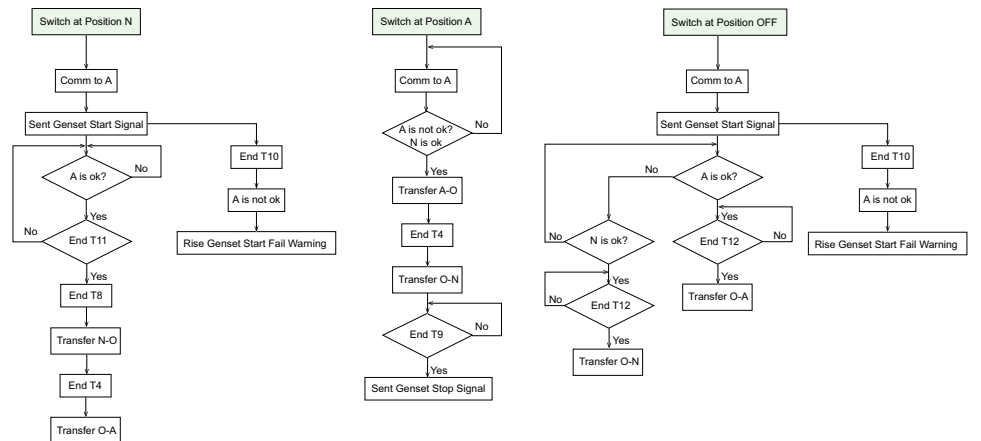

T11 is internal fixed time delay.

## Transfer Logic of Communication to N (U-G Application)

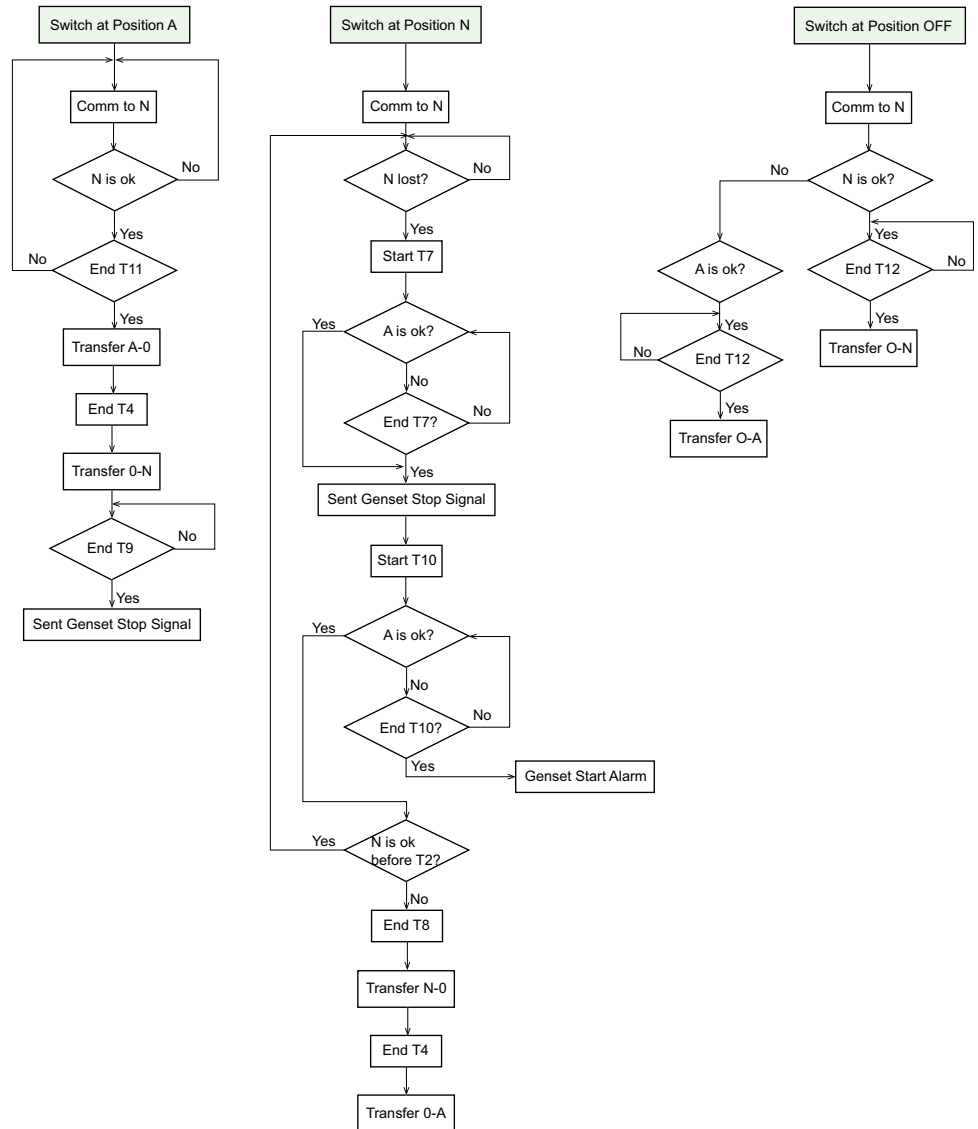

T11 is internal fixed time delay.

## Transfer Logic of Communication to OFF

Comm to OFF is equivalent to local control to off in Local Control Mode, but different to Force to Off Mode. The ATSE will transfer to off after receiving the command without any time delay. For more information, see *Local Control Mode*, page 187.

## Test by Communication

Test by communication support the following three commands:

- On Load Test
- Off Load Test
- Test Exit

When more than one Modbus modules are installed, the ATSE will only response to the module which send the command first. It will not response to any command from other modules until the first module send the Test Exit command.

When the test is ongoing, ATSE ignores any other signal from active automatic HMI or DI module (TPCDIO07).

The operation of Test by communication is equivalent to Test mode. For more information, see [Test Mode](#), page 181

### Step 1

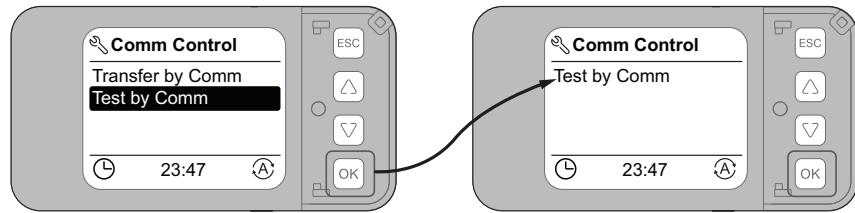

### Step 2

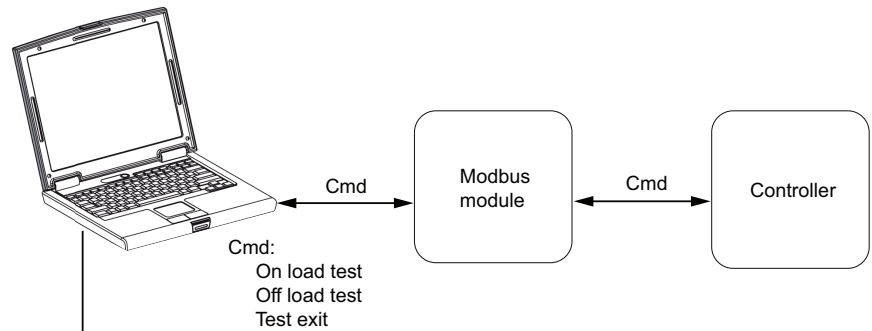

### Step 3



## Stop Test by Communication

There are three ways to stop the test:

- The Modbus master device send Test Exit command to the active Modbus module installed on ATSE.
- Turn off Test by Comm from active automatic HMI.
- The active Modbus module is offline.

## Voluntary Transfer Mode

The voluntary transfer mode is equivalent to auto-priority mode on one source, with forced priority to the SI or SII source. It is activated when associated input is closed (The commercial reference number for the voluntary remote control module is TPCDIO08). It takes over 200 ms to active the voluntary mode. The signal for voluntary transfer should be constant.

Voluntary transfer is normally used for special tariffs. Once the mode is set from voluntary to N or A, ATSE is still remains in auto mode. When there is power contingency on target source, transfer switch can re-transfer to available source automatically.

**NOTE:** Auto transfer will not be active, if transfer action damages driving system (for example, both sources are out of range, TSE refuses to transfer) .

The following are the voluntary transfer mode use cases:

### Use Case 1: Typhon Mode

During typhoon or earthquake, the Genset will be more stable than utility. The user for this case has installed a typhoon mode switch on his control panel. The user will activate the typhoon mode switch. It is connected to the input voluntary transfer mode which will transfer to alternate source (need accessory to have function of voluntary transfer using TPCDIO08 accessories). The ATSE will now activate the Genset output and will transfer to Genset once ready.

Now during the typhoon, the Genset is flooded. The ATSE will still be in auto mode. It detects alternate source failure. If the normal source is fine, it will try to transfer to normal source (voluntary is still an auto mode, and we have auto-return). If the normal source is not available then ATSE will not do any transfer.

Still during typhoon, the Genset can restart (it was a fuel level problem). As the typhoon mode switch is still enabled, the ATSE will transfer back to the Genset. The Genset output keeps activate.

So, whatever the source is connected, the typhoon is gone. The utility is back to normal. The user will deactivate the typhoon mode switch. The ATSE will be transfer back to normal source at auto mode with auto-return, U-G.

The configuration needed is a ATSE along with voluntary transfer module. With this configuration, the user don't need to play with any ATSE settings (return mode, priority source, what is the normal source).

### Use Case 2: Peak Tariff (Align with Controller UA/BA)

Initially this feature was created in UA BA in France for Special Tariff Fare (STF) capability. Special Tariff Fare (STF) in France is a special electricity pricing that allows to have discount price on low consumption hours, with the drawback of having a very expensive kWh price on peak hours. With this option, EDF (French utility) provides an output on the energy meter to warn the end user about the price increase. This output is wired on the voluntary transfer input of the controller, which automatically transfers the load to a cheaper alternate source. This allows to help shedding the peaks on the network.

### Transfer Logic of Voluntary to A (U-U Application)

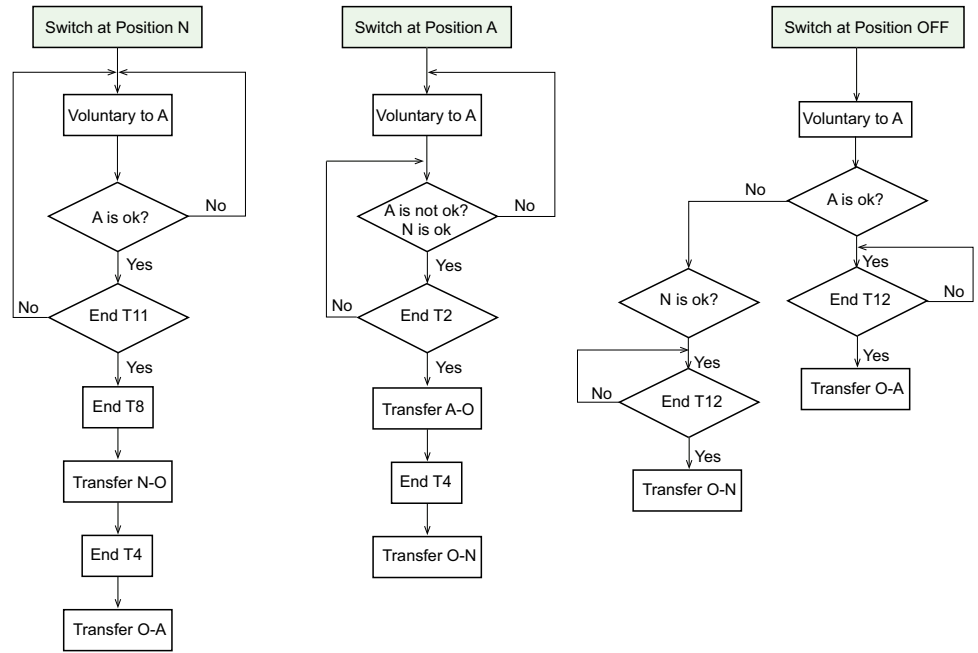

T11 is internal fixed time delay

### Transfer Logic of Voluntary to N (U-U Application)

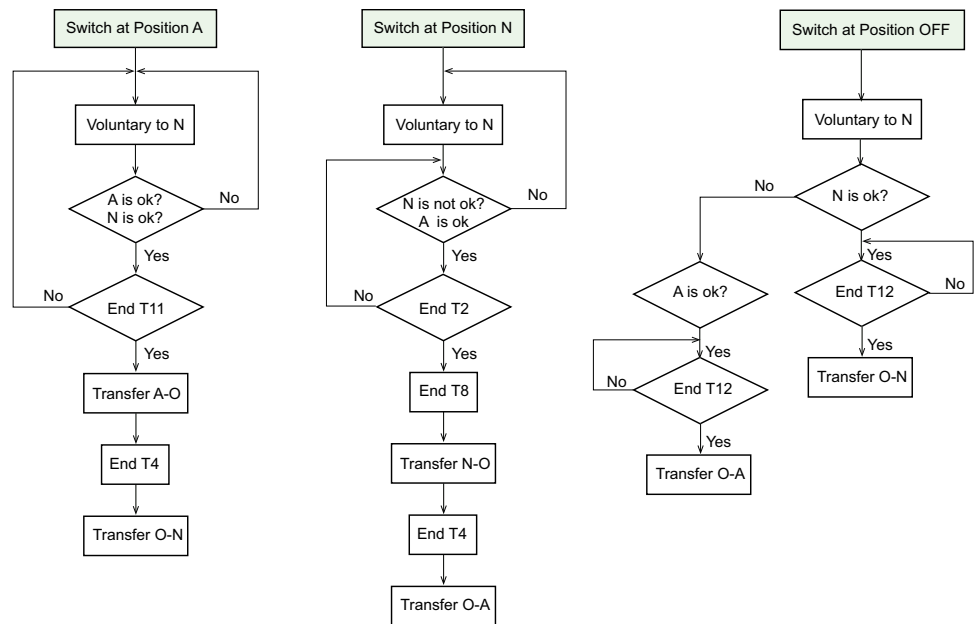

T11 is internal fixed time delay

### Transfer Logic of Voluntary to A (U-G Application)

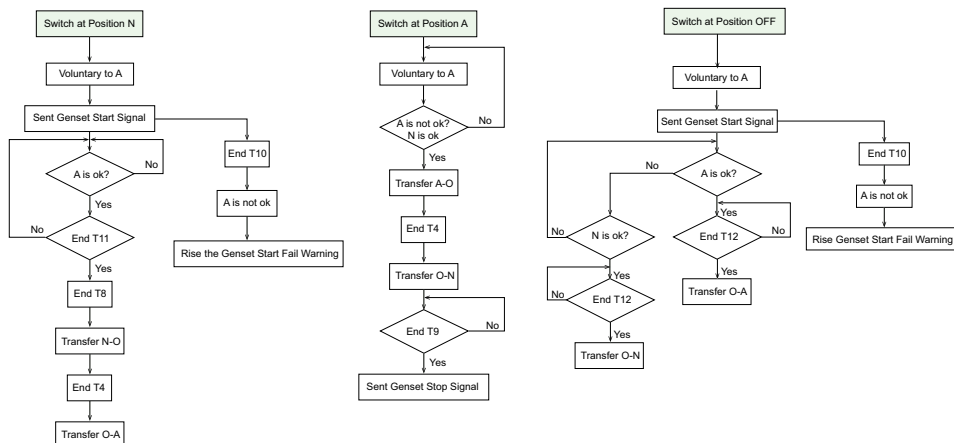

T11 is internal fixed time delay

### Transfer Logic of Voluntary to N (U-G Application)

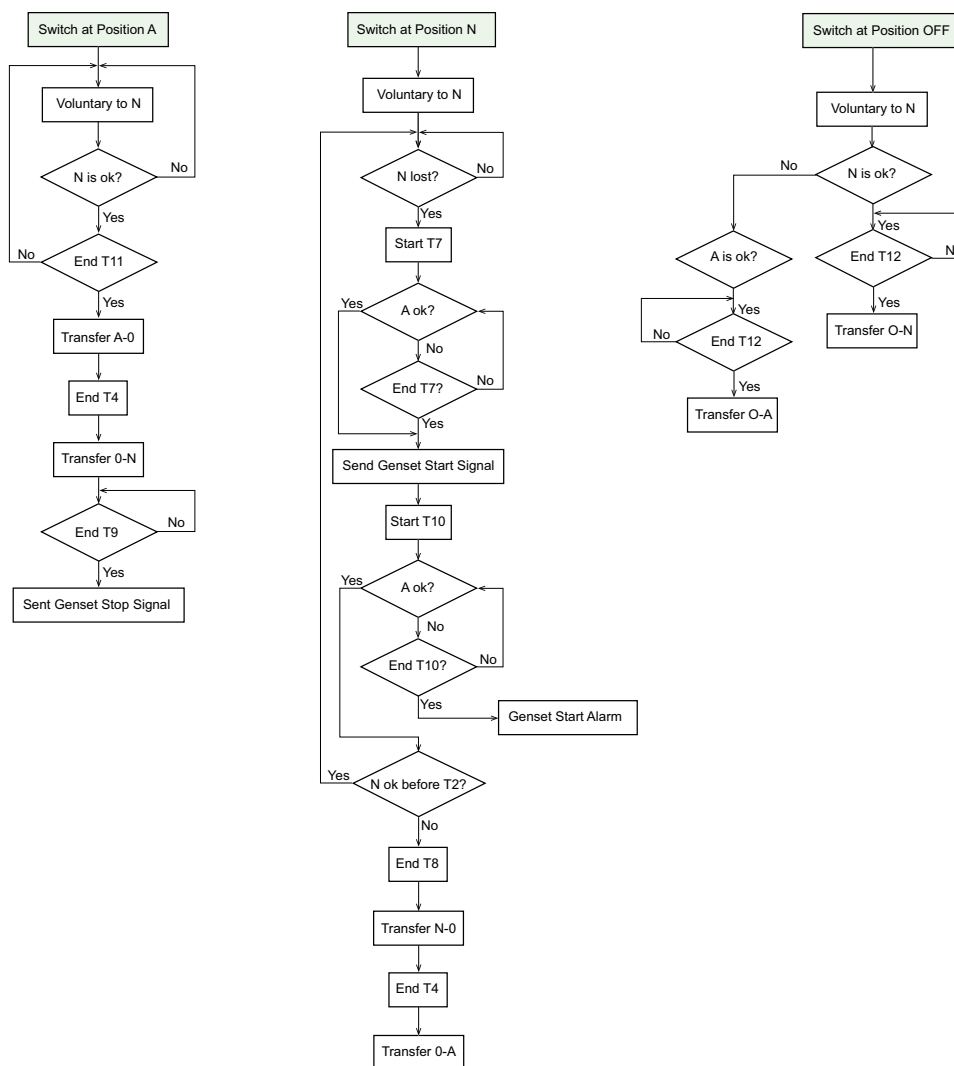

T11 is internal fixed time delay

## Test Mode

The test mode is a procedure to simulate the transfer process with following purpose:

- Test normal transfer actions for ATSE-On load test
- Test Genset-Off load test
- Test Genset-Transfer functions-On load test

## Ways to Start Test

There are three ways to start the test:

- Through Active Automatic HMI
- Through DI using TPCDIO07 module
- Through Modbus communication using TPCCOM16 module

There is no priority among the test command from HMI, DI and Modbus. ATSE will act upon receiving the command from any way.

When the test is ongoing, ATSE ignores any other command until receiving the command to exit test.

Command to exit test should be sent through the same way used to start the test. Otherwise ATSE will not respond. For example, if you start the test through DI module, you have to stop the test through DI module as well.

## Default Time for Test

- Default as unlimited test (no time duration, has to stop the test manually).
- If select limited test, the default time duration is 30 s.

## Time Range for Test

- 1–1800 s with steps of 1 s.
- Time delay can be bypassed by pressing **ESC** key in Active Automatic HMI.

## Pre-Condition to Start Test Mode

The following conditions are mandatory for the test:

- ATSE is in auto mode.
- ATSE is in normal position while in U to U application.
- ATSE is in alternate position while in U to U application.
- ATSE is in normal position while in U to G application.
- For U-U application, A source shall be available before test. Otherwise, there will be an alarm.

**NOTE:** On load test will not be active, if transfer action damages driving system (for example, both sources are out of range, TSE refuses to transfer).

The test will abort in the following conditions :

- Source N is abnormal during the T7, T10, T2, T13, and T14 delay.
- Interrupted by higher priority signals (refer to priority of control mode A-15).
- When not in the T8 and T4 phases, the controller terminates the current test after receiving the stop request.
- The Onload test fails.

## Off Load Test

- The purpose of this function is to check the genset can start without power interruption.

**NOTE:**

- This test does not check if the switch is able to make the transfer.
- The test is only available with U-G configuration.
- The offload test should not be proposed, when the ATSE does not have genset output feature.
- This function will only be accessible for product with HMI, as the Test mode default value is On load.
- The orders from higher priority will interrupt the test procedure.

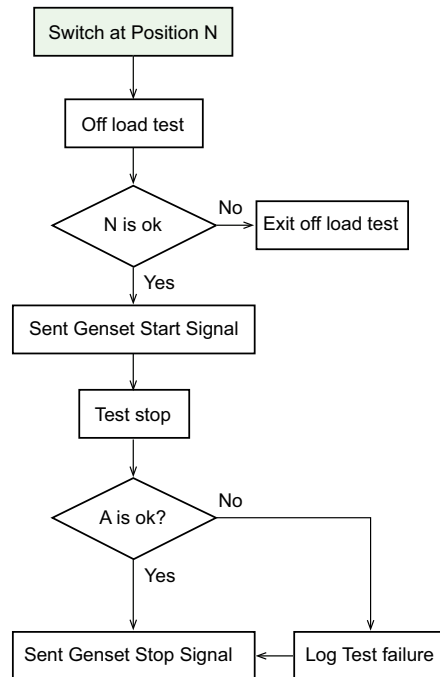

**T14 is Unlimited**

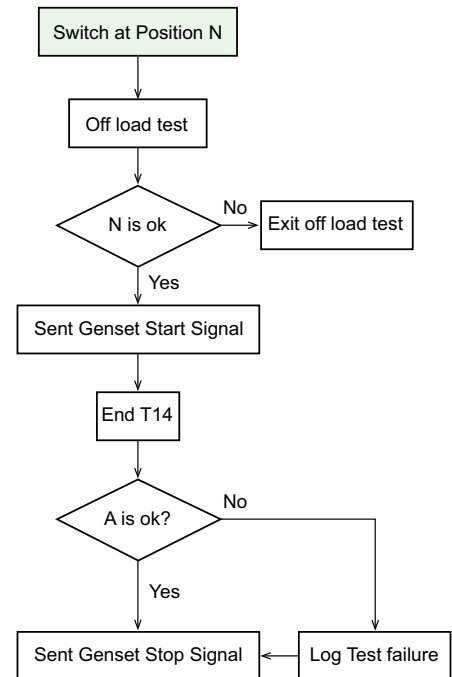

**T14 is Limited**

## On Load Test

- The purpose of this function is to execute ATSE transfer (when the source is still valid) to make sure the system is still able to execute the transfer. The U-U and U-G configuration are both available.
- When the ATSE receive the testing start request:
  - The ATSE shall initiate the transfer to the Alternate source if the Alternate source is in range, and according to the transfer delays (T7, T2...).
  - The ATSE shall log a test start event.
- Two conditions to return to N source:
  - When the ATSE receive the stop request from user.
  - When the Test timer is activated, and the test timer is completed.

## Logic of On Load Test U-U

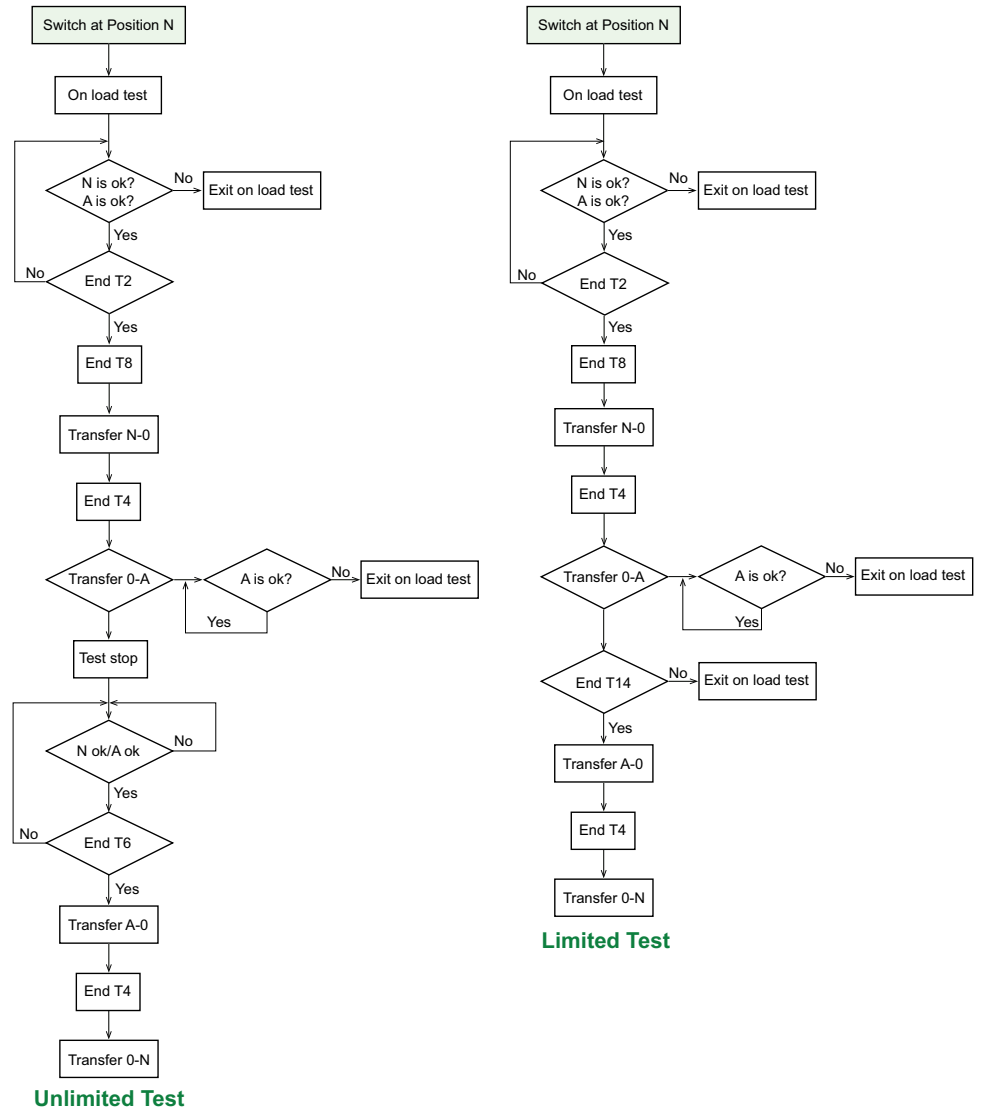

## Logic of On Load Test U-G

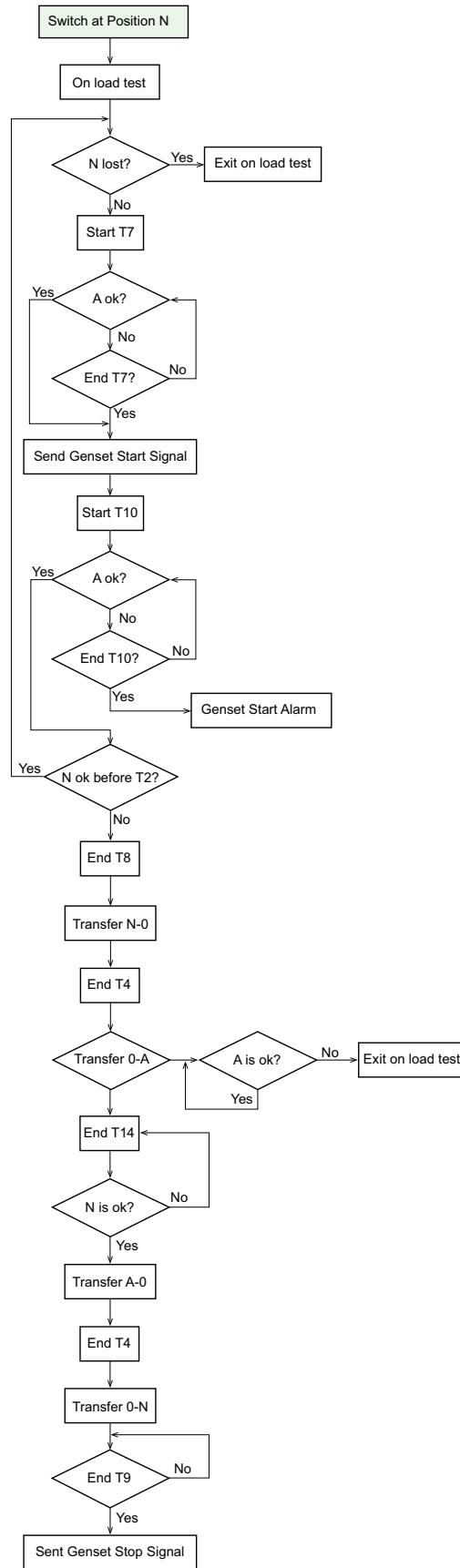

### Limited Test

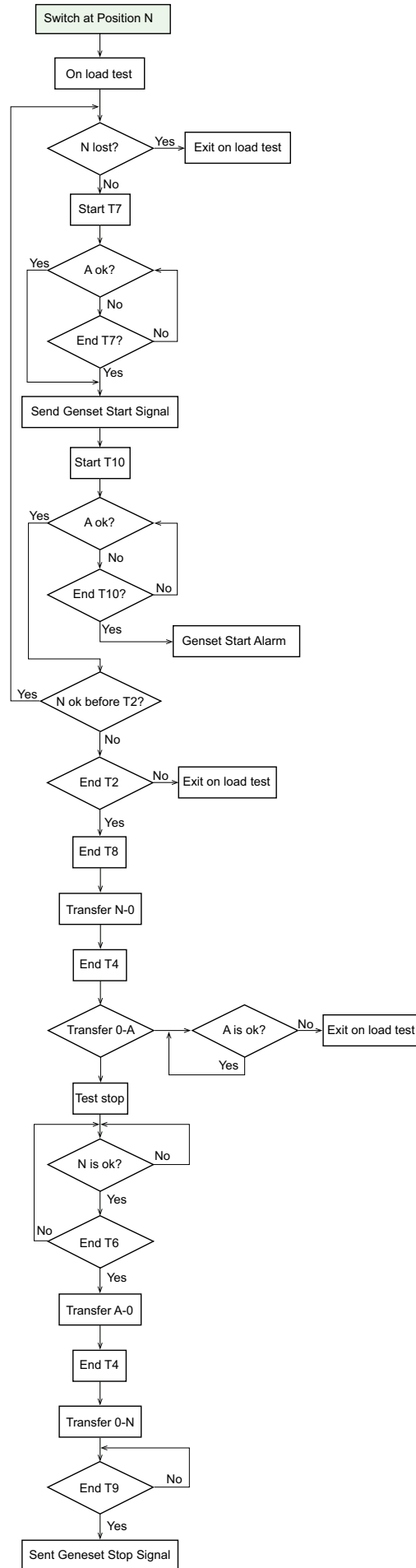

**Unlimited Test**

## Return or Start from Auto Mode at Off Position

When switch is at OFF position, this state is interim, and it happens under two conditions:

- Enter the auto mode from other modes or from power on.
- End of off delay (T4), ATSE is unable to switch to N or A, due to both power source loss (with 24 V).

The load shedding will be activated from OFF to A source in both U-U and U-G configuration.

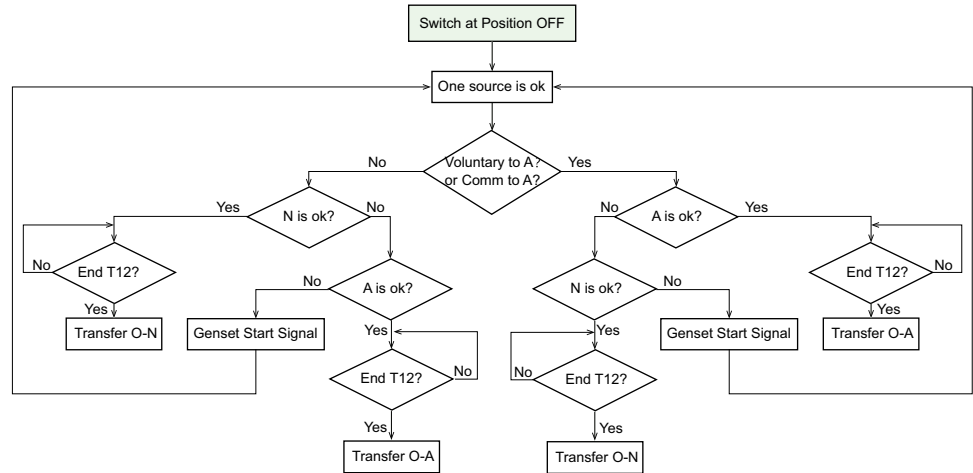

T12 is internal fixed time delay.

## Local Control Mode

### **⚠ CAUTION**

#### **HAZARD OF EQUIPMENT DAMAGE**

Enable the local control through Active Automatic HMI to exit the auto mode.

**Failure to follow these instructions can result in injury or equipment damage.**

### **NOTICE**

#### **POTENTIAL POWER OUTAGE OF EQUIPMENT**

To re-enter Auto mode, disable local control through Active Automatic HMI or External HMI.

**Failure to follow these instructions can result in equipment damage.**

The local mode is activated through the HMI (only available for Active Automatic HMI). It allows locally to change the logical position of the TSE. The switch will refuse to active if the action will damage the driving system. It cannot transfer to unavailable source.

**NOTE:** Local transfer will not be active, if transfer action damage driving system (for example, both sources are out of range, TSE refuses to transfer) or both sources are out of operating voltage of solenoid.

Auto Genset start signal and load shedding signal is not available for this mode. In this case, the target source conformity is verified before transfer and time delays are not considered.

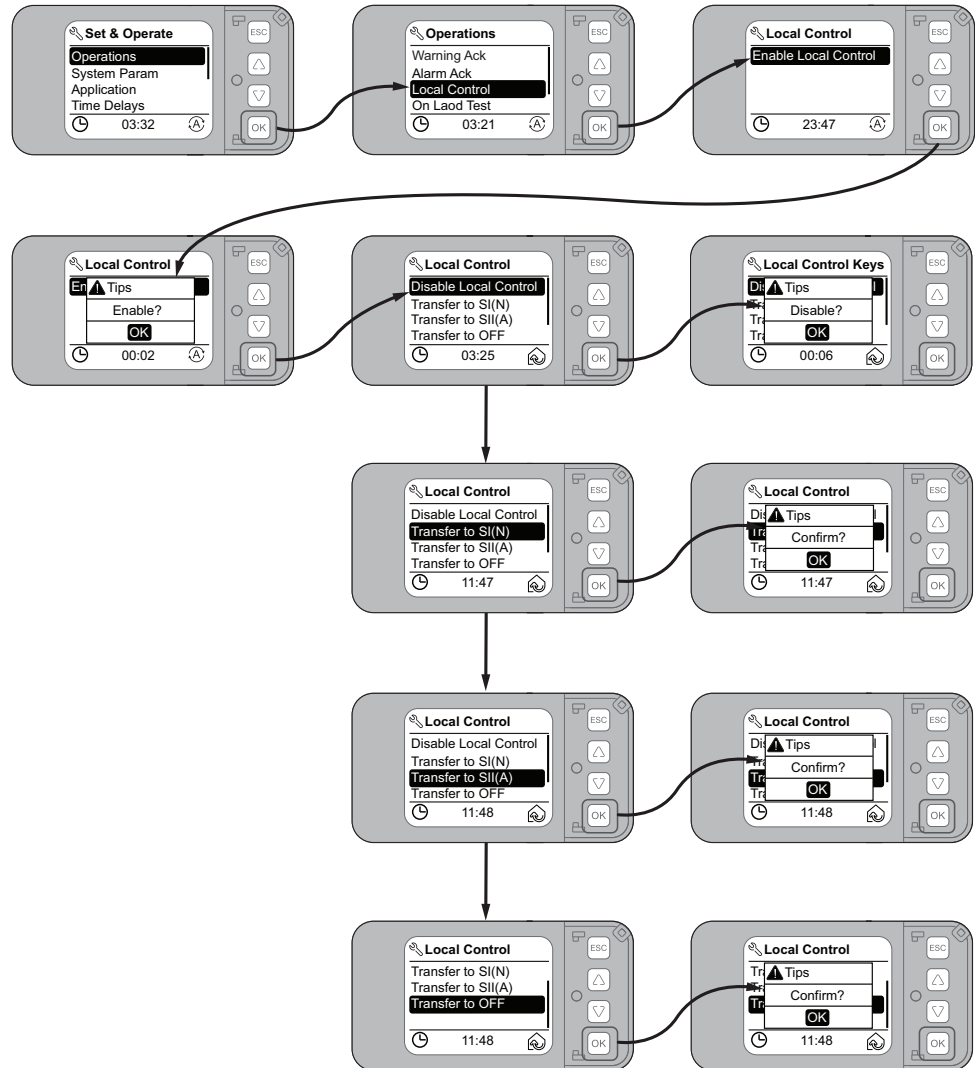

## Local Control to N

The command is sent through HMI. There is no time delay except OFF delay.

The switch will transfer to normal after receiving the order to it when normal power is in tolerance.

## Local Control to A

The command is sent through HMI. There is no time delay except OFF delay.

The switch will transfer to alternate after receiving the order to it when alternate power is in tolerance.

## Local Control to O

The command is sent through HMI. There shall be no time delay. The switch will transfer to OFF after receiving the order to it.

## Transfer Inhibit Mode

When the transfer inhibition input is active, the controller can not send any order to TSE. Front face selection buttons are locked and the HMI only display transfer inhibit.

Fire, Force to OFF and Handle mode still works as before. When exit Fire, Force to OFF and Handle mode, transferring blocked by transfer inhibit.

Use this mode only when inhibit signal (from DI) is active and no higher operation mode is running. When ATS transfer is ongoing, wait until transfer completed.

Exit this mode after inhibit signal is inactive.

Accessories are required using TPCDIO07 to extend this function of the TSE.

## Application

- Transfer inhibit occurs when there is power interruption because of short circuit.
- This function can be used to lock the controller by customized signals.
- This function can be used for cooperation with different ATSE.

## Fire Protection Mode

- An emergency stop order to transfer ATSE to off position. All the other transfer mode will be canceled except force to OFF and handle control. There shall be no time delay.
- Exit fire protection after signal disappeared.
- Require accessories TPCDIO10 or TPCDIO11 or TPCDIO13 or TPCDIO14 to extend this function.

## Application

- The fire protection signal can transfer ATSE to off position when there is fire emergency.

## Force to Off Mode

- Transfer ATSE to OFF position with an emergency stop order. All the other transfer mode will be canceled except handle control. There should be no time delay.
- Exit Force after signal disappeared.
- Accessories are required using TPCDIO07 to extend this function of TSE.

## Handle Transfer Mode

- The handle or manual transfer mode is activated from the TSE directly. It deactivates the controller control function except position status (outputs and LEDs), source status LEDs and alarm LED.
- No operation for load shedding and generator, keep the status as before.
- No alarm relay output.

# Operations on RTSE

## What's in This Chapter

Overview .....	191
Remote Transfer Process .....	191
Remote Transfer Condition .....	191

## Overview

The RTSE transfers to a stable position after receiving a rising edge signal. The rising edge signal should last for no less than 200 ms.

The RTSE will remain on the stable position until receiving a new signal. It will not respond to the new signal when:

- Position slider is in the left and transfer switch equipment is in RUN mode.
- Transfer switch equipment is in alarm state.
- Transfer switch equipment is executing the transfer action.

## Remote Transfer Process

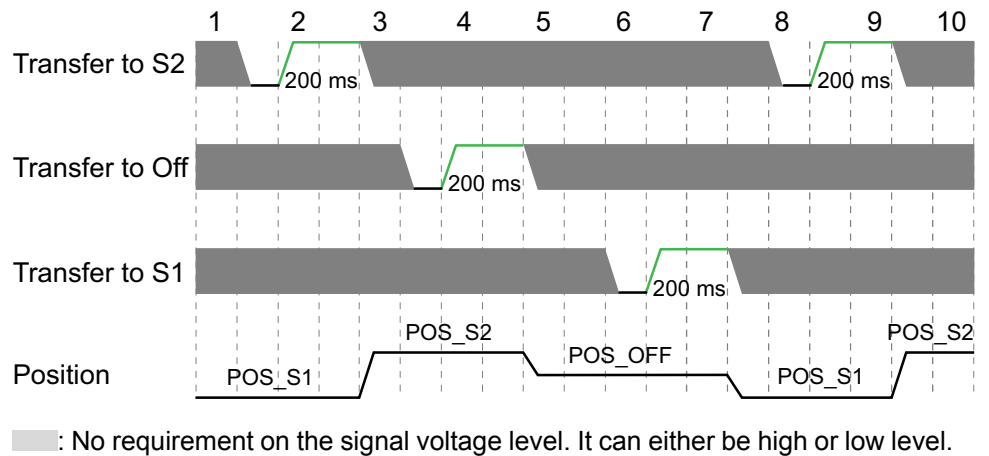

## Remote Transfer Condition

If either source is in range, transfer will be successful. If both sources are out of range, remote transfer command will still be responded, but the result of transferring to the target source is not guaranteed.

Below is the supported voltage deviation range for RTSE with different rated voltage:

- 380–440 V: 274 - 517 V
- 208–240 V: 174 - 280 V

# Modbus Communication

## What's in This Chapter

Introduction.....	193
Modbus Client-Server Principle .....	193
Modbus Functions .....	197
Modbus Exception Codes .....	200
Modbus Registers .....	201

## Introduction

The Modbus communication option enables Schneider Electric low voltage switches to be connected to a supervisor or to any other device with a master Modbus communication channel.

## Modbus Client-Server Principle

### Overview

The Modbus protocol exchanges information using a request-reply mechanism between a client and a server. The Client-Server principle is a model for a communication protocol in which one device (the client) controls one or more other devices (the server). In a standard Modbus network, there is 1 client and up to 31 servers.

A detailed description of the Modbus protocol is available at [www.modbus.org](http://www.modbus.org).

### Characteristics of the Client-Server Principle

The client-server principle is characterized as follows:

- Only 1 client is connected to the network at a time.
- Only the client can initiate communication and send requests to the servers.
- The client can address each server individually using its specific address or all servers simultaneously using address 0.
- The servers can only send replies to the client.
- The servers cannot initiate communication, either to the client or to other servers.

### Client-Server Communication Modes

The Modbus protocol can exchange information using 2 communication modes:

- unicast mode
- broadcast mode

## Unicast Mode

In unicast mode, the client addresses a server using the specific address of the server. The server processes the request then replies to the client.

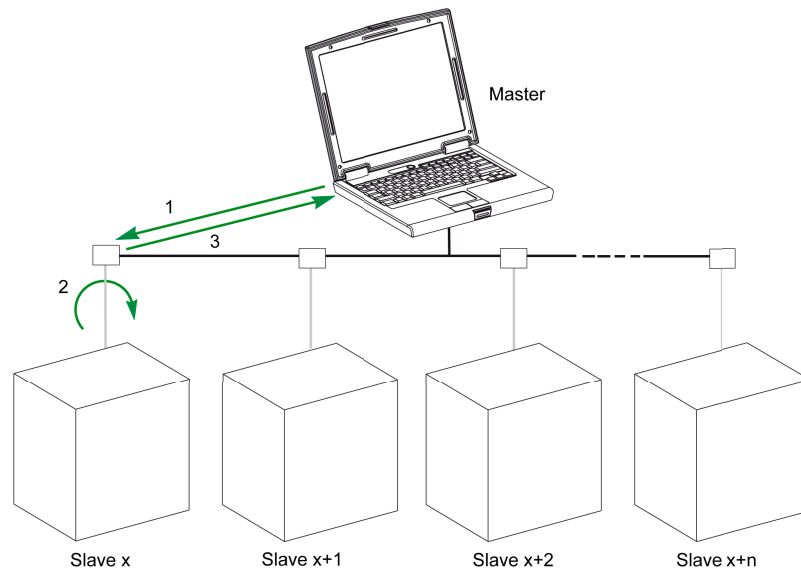

1 Request

2 Process

3 Reply

## Broadcast Mode

The client can also address all servers using address 0. This type of exchange is called broadcasting. The servers do not reply to broadcasting messages.

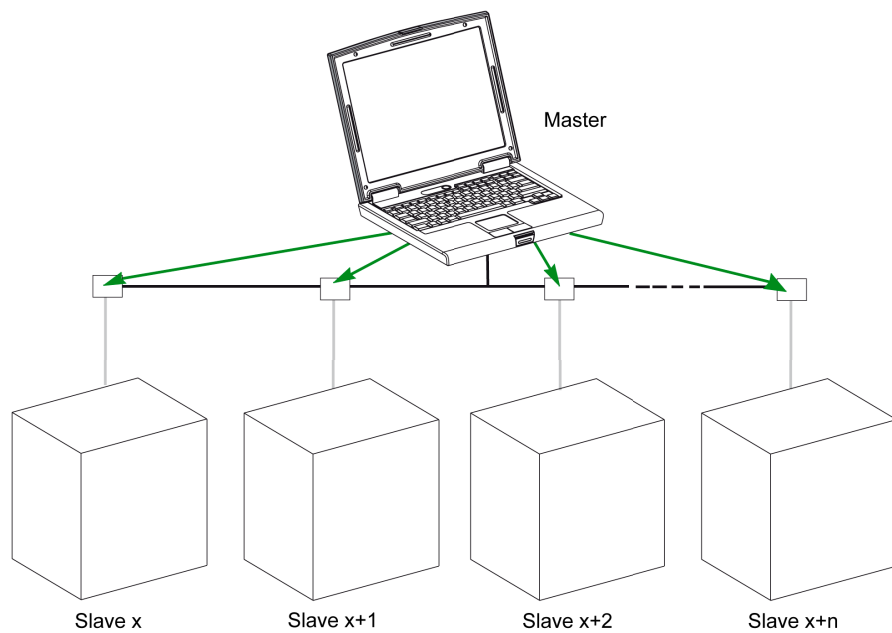

## Response Time

The response time  $T_r$  is the time needed by a server to respond to a request sent by the client:

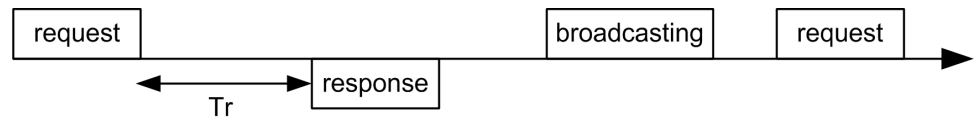

Values with the Modbus protocol:

- Typical value < 10 ms for 90% of the exchanges
- To normal messages,  $T_r$  maximum value is around 700 ms, so it is recommended to implement a 1 second time out after sending a Modbus request.

## Data Exchange

The Modbus protocol uses 2 types of data:

- Single bit
- Register (16 bits)

Each register has a register number. Each type of data (bit or register) has a 16-bit address.

The messages exchanged with the Modbus protocol contain the address of the data to be processed.

## Registers and Addresses

The address of register number  $n$  is  $n-1$ . The tables detailed in the following parts of this document provide both register numbers (in decimal format) and corresponding addresses (in hexadecimal format). For example, the address of register number 12000 is 0x2EDF (11999).

## Frames

All the frames exchanged with the Modbus RTU protocol have a maximum size of 256 bytes and are composed of 4 fields:

Field	Definition	Size	Description
1	server number	1 byte	Destination of the request <ul style="list-style-type: none"> <li>• 0: broadcasting (all servers concerned)</li> <li>• 1–247: unique destination</li> </ul>
2	Function codes	Only 1 byte	Refer to Modbus Functions, page 197
3	Data	$n$ registers	Request or reply data
4	Check	2 bytes	CRC16 (to check transmission errors)

## Default Settings

Followings are the default settings of Modbus communication.

Item	Setting
Baud rate	19200 bps
Data	8 bits
Parity	Even
Stop	1 bit
Address	1

# Modbus Functions

## General Description

The Modbus protocol offers a number of functions that are used to read or write data over the Modbus network. The Modbus protocol also offers diagnostic and network-management functions.

Only the Modbus functions handled by the ATSE are described here.

## Read Functions

The following read functions are available:

Function Code	Subfunction Code	Name	Description
3 (0x03)	–	Read holding registers	Read n output or internal registers
43 (0x2B)	14 (0x0E)	Read device identification	Read the identification data of the server
43 (0x2B)	15 (0x0F)	Get date and time	Read the date and time of the server

## Read Register Example

The following table shows how to read the SI voltage in register 2000. The address of register 2000 is  $2000-1=1999 = 0x07CF$ . The Modbus address of the Modbus server is  $47 = 0x2F$ .

Client Request		Server Reply	
Field Name	Example	Field Name	Example
Modbus server address	0x2F	Modbus server address	0x2F
Function code	0x03	Function code	0x03
Address of the register to read (MSB)	0x07	Data length in bytes	0x02
Address of the register to read (LSB)	0xCF	Register value (MSB)	0x02
Number of registers (MSB)	0x00	Register value (LSB)	0x2B
Number of registers (LSB)	0x01	CRC (MSB)	0xFF
CRC (MSB)	0xFF	CRC (LSB)	0xFF
CRC (LSB)	0xFF	–	

## Get Date and Time Example

The following table shows how to get the date and time of a Modbus server. The Modbus address of the Modbus server is  $47 = 0x2F$ .

client Request		Server Reply	
Field Name	Example	Field Name	Example
Modbus server address	0x2F	Modbus server address	0x2F
Function code	0x2B	Function code	0x2B
Subfunction code	0x0F	Subfunction code	0x0F
Reserved	0x00	Reserved	0x00
–	–	Date and time	Refer to the DATETIME data type

## Set Date and Time Example

The following table shows how to set date and time of a Modbus server. The Modbus address of the Modbus server is 47 = 0x2F, the new date is October 2, 2014, and the new time is 2:32:03:500 p.m.

**NOTE:** Use the broadcast mode (with Modbus server address = 0) to set the date and time of all Modbus servers.

client Request		Server Reply	
Field Name	Example	Field Name	Example
Modbus server address	0x2F	Modbus server address	0x2F
Function code	0x2B	Function code	0x2B
Subfunction code	0x10	Subfunction code	0x10
Reserved1	0x00	Reserved1	0x00
Not used	0x00	Not used	0x00
Year = 2014	0x0E	Year = 2014	0x0E
Month = October	0x0A	Month = October	0x0A
Day Of Month = 2	0x02	Day Of Month = 2	0x02
Hour = 14	0x0E	Hour = 14	0x0E
Minutes = 32	0x20	Minutes = 32	0x20
3 sec. 500 ms	0x0DAC	3 sec. 502 ms	0x0DAE

The normal response is an echo of the request, returned after the date-time has been updated in the remote device. If the date-time structure content is not consistent with a true date-time (that is, an invalid date-time), the value returned in the Date-Time field is set to 0 by the device.

In case of 24 VDC power loss, the date and time of the Modbus servers without battery is not refreshed anymore. It is therefore mandatory to set date and time for all Modbus servers after recovering the 24 VDC power supply.

Furthermore, due to the clock drift of each Modbus server, it is mandatory to set date and time for all Modbus servers periodically. Recommended period is at least every 15 minutes.

## Scattered Holding Register Read Function

The scattered holding register read function is available:

Function	Subfunction Code	Name	Description
100 (0x64)	4 (0x04)	Read scattered holding register	Read n non-contiguous registers

The scattered holding register read function enables the user to:

- avoid reading a large block of contiguous registers when only few registers are needed
- avoid multiple use of functions 3 and 4 in order to read non-contiguous registers

## Read Scattered Holding Register Example

The following table shows how to read the addresses of the register 1022 (address 0x03FD) and register 1100 (address 0x044B) of a Modbus server. The Modbus address of the Modbus server is 47 = 0x2F.

Client Request		Server Reply	
Field Name	Example	Field Name	Example
Modbus server address	0x2F	Modbus server address	0x2F
Function code	0x64	Function code	0x64
Data length in bytes	0x06	Data length in bytes	0x06
Subfunction code	0x04	Subfunction code	0x04
Transmission number <sup>(1)</sup>	0xXX	Transmission number <sup>(1)</sup>	0xXX
Address of first register to read (MSB)	0x03	Value of the first register read (MSB)	0x12
Address of first register to read (LSB)	0xFD	Value of the first register read (LSB)	0x0A
Address of second register to read (MSB)	0x04	Value of the second register read (MSB)	0x74
Address of second register to read (LSB)	0x4B	Value of the second register read (LSB)	0x0C
CRC (MSB)	0xXX	CRC (MSB)	0xXX
CRC (LSB)	0xXX	CRC (LSB)	0xXX

(1) The client gives the transmission number in the request. The server returns the same number in the reply.

## Write Functions

The following write functions are available:

Function Code	Subfunction Code	Name	Description
6 (0x06)	–	Preset single register	Write 1 register
16 (0x10)	–	Preset multiple registers	Write n registers
43 (0x2B)	16 (0x10)	Set date and time	Write the date and time of the server

# Modbus Exception Codes

## Exception Responses

Exception responses from either the client or a server can result from data processing errors. One of the following events can occur after a request from the client:

- If the server receives the request from the client without a communication error and can handle the request correctly, it returns a normal response.
- If the server does not receive the request from the client due to a communication error, it does not return a response. The client program eventually processes a timeout condition for the request.
- If the server receives the request from the client but detects a communication error, it does not return a response. The client program eventually processes a timeout condition for the request.
- If the server receives the request from the client without a communication error, but cannot handle it (for example, the request is to read a register that does not exist), the server returns an exception response to inform the client of the nature of the error.

## Exception Frame

The server sends an exception frame to the client to report an exception response. An exception frame is composed of 4 fields:

Field	Definition	Size	Description
1	Server number	1 byte	Destination of the request <ul style="list-style-type: none"> <li>• 1–247: unique destination</li> </ul>
2	Exception function code	1 byte	Request function code + 128 (0x80)
3	Exception code	n bytes	See next paragraph
4	Check	2 bytes	CRC16 (to check transmission errors)

## Exception Codes

The exception response frame has two fields that differentiate it from a normal response frame:

- The exception function code of the exception response is equal to the function code of the original request plus 128 (0x80).
- The exception code depends on the communication error that the server encounters.

The following table describes the exception codes handled by the ATSE:

Exception Code	Name	Description
01 (0x01)	Illegal function	The function code received in the request is not an authorized action for the server. The server may be in the wrong state to process a specific request.
02 (0x02)	Illegal data address	The data address received by the server is not an authorized address for the server.
03 (0x03)	Illegal data value	The value in the request data field is not an authorized value for the server.
04 (0x04)	Server device failure	The server fails to perform a requested action because of an unrecoverable error.

## Modbus Registers

The main information needed for remote supervision of a TransferPacT Switching Equipment is contained in the table of common registers starting at register 1001.

One Modbus read request is limited to 125 registers maximum. Three Modbus read requests are necessary to read the entire table.

Use of these common registers is highly recommended to optimize response times and simplify the use of data.

### Table Format

Register tables have the following columns:

Address	Register	Pole number	R/W	Unit	Type	Range	TA	Bit	Description

- **Address:** a 16-bit register address in hexadecimal. The address is the data used in the Modbus frame.
- **Register:** a 16-bit register number in decimal (register = address + 1).
- **Pole number:** number of poles that are applicable for that register.
- **R/W:** register read-write status
  - R: the register can be read by using Modbus functions
  - W: the register can be written by using Modbus functions
  - RW: the register can be read and written by using Modbus functions
  - RC: the register can be read by using the command interface
  - WC: the register can be written by using the command interface
- **Unit:** the unit the information is expressed in.
- **Type:** the encoding data type (see data type description below).
- **Range:** the permitted values for this variable, usually a subset of what the format allows.
- **TA:** type of TransferPacT switch for which the register is available.
- **Bit:** bit position applicable for that register.
- **Description:** provides information about the register and restrictions that apply.

### TransferPacT Switching Equipment Register

Address	Register	Pole number	R/W	Unit	Type	Range	TA	Bit	Description
0x03E8	1001	ALL	R	EN-UM	ENUM	–	TA	–	Switch position <ul style="list-style-type: none"> <li>• 1 = at N position</li> <li>• 2 = at A position</li> <li>• 4 = at OFF position</li> <li>• others = error</li> </ul>
0x03EA	1003	ALL	R	EN-UM	ENUM	–	TA	–	Normal source state <ul style="list-style-type: none"> <li>• 0 = Source in range</li> <li>• 1 = Source out of range</li> <li>• 2 = No voltage</li> </ul>

Address	Register	Pole number	R/W	Unit	Type	Range	TA	Bit	Description
0x03EC	1005	ALL	R	ENUM	ENUM	–	TA	–	Alternate source state <ul style="list-style-type: none"> <li>• 0 = Source in range</li> <li>• 1 = Source out of range</li> <li>• 2 = No voltage</li> </ul>
0x03ED	1006	4P	R	–	BOOL	–	TA	0	SI phase sequence error validity <ul style="list-style-type: none"> <li>• 0 = Invalid</li> <li>• 1 = Valid</li> </ul>
0x03ED	1006	4P	R	–	BOOL	–	TA	1	SI neutral position wrong validity <ul style="list-style-type: none"> <li>• 0 = Invalid</li> <li>• 1 = Valid</li> </ul>
0x03ED	1006	3P/4P	R	–	BOOL	–	TA	2	SI unbalance voltage validity <ul style="list-style-type: none"> <li>• 0 = Invalid</li> <li>• 1 = Valid</li> </ul>
0x03ED	1006	4P	R	–	BOOL	–	TA	3	SI neutral loss alarm validity <ul style="list-style-type: none"> <li>• 0 = Invalid</li> <li>• 1 = Valid</li> </ul>
0x03ED	1006	ALL	R	–	BOOL	–	TA	4	SI over voltage state validity <ul style="list-style-type: none"> <li>• 0 = Invalid</li> <li>• 1 = Valid</li> </ul>
0x03ED	1006	ALL	R	–	BOOL	–	TA	5	SI under voltage state validity <ul style="list-style-type: none"> <li>• 0 = Invalid</li> <li>• 1 = Valid</li> </ul>
0x03ED	1006	ALL	R	–	BOOL	–	TA	6	SI over frequency state validity <ul style="list-style-type: none"> <li>• 0 = Invalid</li> <li>• 1 = Valid</li> </ul>
0x03ED	1006	ALL	R	–	BOOL	–	TA	7	SI under frequency state validity <ul style="list-style-type: none"> <li>• 0 = Invalid</li> <li>• 1 = Valid</li> </ul>
0x03EE	1007	4P	R	–	BOOL	–	TA	0	SI phase sequence error <ul style="list-style-type: none"> <li>• 1 = Yes</li> </ul>
0x03EE	1007	4P	R	–	BOOL	–	TA	1	SI neutral position wrong <ul style="list-style-type: none"> <li>• 1 = Yes</li> </ul>
0x03EE	1007	3P/4P	R	–	BOOL	–	TA	2	SI unbalance voltage status <ul style="list-style-type: none"> <li>• 1 = Yes</li> </ul>
0x03EE	1007	4P	R	–	BOOL	–	TA	3	SI neutral loss alarm <ul style="list-style-type: none"> <li>• 1 = Yes</li> </ul>
0x03EE	1007	ALL	R	–	BOOL	–	TA	4	SI over voltage state <ul style="list-style-type: none"> <li>• 1 = Yes</li> </ul>
0x03EE	1007	ALL	R	–	BOOL	–	TA	5	SI under voltage state <ul style="list-style-type: none"> <li>• 1 = Yes</li> </ul>
0x03EE	1007	ALL	R	–	BOOL	–	TA	6	SI over frequency state <ul style="list-style-type: none"> <li>• 1 = Yes</li> </ul>
0x03EE	1007	ALL	R	–	BOOL	–	TA	7	SI under frequency state <ul style="list-style-type: none"> <li>• 1 = Yes</li> </ul>
0x03EF	1008	4P	R	–	BOOL	–	TA	0	SII phase sequence error validity <ul style="list-style-type: none"> <li>• 0 = Invalid</li> <li>• 1 = Valid</li> </ul>
0x03EF	1008	4P	R	–	BOOL	–	TA	1	SII neutral position wrong validity <ul style="list-style-type: none"> <li>• 0 = Invalid</li> <li>• 1 = Valid</li> </ul>
0x03EF	1008	3P/4P	R	–	BOOL	–	TA	2	SII unbalance voltage validity

Address	Register	Pole number	R/W	Unit	Type	Range	TA	Bit	Description
									<ul style="list-style-type: none"> <li>• 0 = Invalid</li> <li>• 1 = Valid</li> </ul>
0x03EF	1008	4P	R	–	BOOL	–	TA	3	SII neutral loss alarm validity <ul style="list-style-type: none"> <li>• 0 = Invalid</li> <li>• 1 = Valid</li> </ul>
0x03EF	1008	ALL	R	–	BOOL	–	TA	4	SII over voltage state validity <ul style="list-style-type: none"> <li>• 0 = Invalid</li> <li>• 1 = Valid</li> </ul>
0x03EF	1008	ALL	R	–	BOOL	–	TA	5	SII under voltage state validity <ul style="list-style-type: none"> <li>• 0 = Invalid</li> <li>• 1 = Valid</li> </ul>
0x03EF	1008	ALL	R	–	BOOL	–	TA	6	SII over frequency state validity <ul style="list-style-type: none"> <li>• 0 = Invalid</li> <li>• 1 = Valid</li> </ul>
0x03EF	1008	ALL	R	–	BOOL	–	TA	7	SII under frequency state validity <ul style="list-style-type: none"> <li>• 0 = Invalid</li> <li>• 1 = Valid</li> </ul>
0x03F0	1009	4P	R	–	BOOL	–	TA	0	SII phase sequence error <ul style="list-style-type: none"> <li>• 1 = Yes</li> </ul>
0x03F0	1009	4P	R	–	BOOL	–	TA	1	SII neutral position wrong <ul style="list-style-type: none"> <li>• 1 = Yes</li> </ul>
0x03F0	1009	3P/4P	R	–	BOOL	–	TA	2	SII unbalance voltage status <ul style="list-style-type: none"> <li>• 1 = Yes</li> </ul>
0x03F0	1009	4P	R	–	BOOL	–	TA	3	SII neutral loss alarm <ul style="list-style-type: none"> <li>• 1 = Yes</li> </ul>
0x03F0	1009	ALL	R	–	BOOL	–	TA	4	SII over voltage state <ul style="list-style-type: none"> <li>• 1 = Yes</li> </ul>
0x03F0	1009	ALL	R	–	BOOL	–	TA	5	SII under voltage state <ul style="list-style-type: none"> <li>• 1 = Yes</li> </ul>
0x03F0	1009	ALL	R	–	BOOL	–	TA	6	SII over frequency state <ul style="list-style-type: none"> <li>• 1 = Yes</li> </ul>
0x03F0	1009	ALL	R	–	BOOL	–	TA	7	SII under frequency state <ul style="list-style-type: none"> <li>• 1 = Yes</li> </ul>
0x03FC	1021	ALL	R	EN-UM	ENUM	–	TA	–	Load shedding function supported <ul style="list-style-type: none"> <li>• 1 = Supported</li> </ul>
0x03FD	1022	ALL	R	EN-UM	ENUM	–	TA	–	Load shedding status <ul style="list-style-type: none"> <li>• 0 = Inactive</li> <li>• 1 = Active</li> </ul>
0x03FE	1023	ALL	R	EN-UM	ENUM	–	TA	–	Genset control status supported <ul style="list-style-type: none"> <li>• 1 = Supported</li> </ul>
0x03FF	1024	ALL	R	EN-UM	ENUM	–	TA	–	Genset control status <ul style="list-style-type: none"> <li>• 0 = Inactive</li> <li>• 1 = Active</li> <li>• 2 = Unable to control</li> </ul>
0x044B	1100	ALL	R	EN-UM	ENUM	–	TA	–	Runtime mode <ul style="list-style-type: none"> <li>• 0 = Init</li> <li>• 1 = Auto</li> <li>• 2 = Test</li> <li>• 3 = Voluntary</li> <li>• 4 = Remote</li> <li>• 5 = Local</li> </ul>

Address	Register	Pole number	R/W	Unit	Type	Range	TA	Bit	Description												
									<ul style="list-style-type: none"> <li>• 6 = Inhibit</li> <li>• 7 = Fire</li> <li>• 8 = Force2off</li> <li>• 9 = Fatal</li> <li>• 10 = Handle</li> </ul>												
0x044F	1104	ALL	R/W	s	FLOAT32	–	TA	–	Generator Ready Alarm Delay T10 • 15 ~ 300												
0x07CF	2000	3P/4P	R	V	FLOAT32	–	TA	–	SI VAB • 0 ~ 6553.5												
0x07D1	2002	3P/4P	R	V	FLOAT32	–	TA	–	SI VBC • 0 ~ 6553.5												
0x07D3	2004	3P/4P	R	V	FLOAT32	–	TA	–	SI VCA • 0 ~ 6553.5												
0x07D5	2006	ALL	R	Hz	FLOAT32	–	TA	–	SI frequency • 0 ~ 6553.5												
0x07D7	2008	2P/4P	R	V	FLOAT32	–	TA	–	SI VAN • 0 ~ 6553.5												
0x07D9	2010	4P	R	V	FLOAT32	–	TA	–	SI VBN • 0 ~ 6553.5												
0x07DB	2012	4P	R	V	FLOAT32	–	TA	–	SI VCN • 0 ~ 6553.5												
0x07DD	2014	3P/4P	R	%	FLOAT32	–	TA	–	SI voltage unbalance rate • 0 ~ 100.0												
0x0833	2100	3P/4P	R	V	FLOAT32	–	TA	–	SII VAB • 0 ~ 6553.5												
0x0835	2102	3P/4P	R	V	FLOAT32	–	TA	–	SII VBC • 0 ~ 6553.5												
0x0837	2104	3P/4P	R	V	FLOAT32	–	TA	–	SII VCA • 0 ~ 6553.5												
0x0839	2106	ALL	R	Hz	FLOAT32	–	TA	–	SII frequency • 0 ~ 6553.5												
0x083B	2108	2P/4P	R	V	FLOAT32	–	TA	–	SII VAN • 0 ~ 6553.5												
0x083D	2110	4P	R	V	FLOAT32	–	TA	–	SII VBN • 0 ~ 6553.5												
0x083F	2112	4P	R	V	FLOAT32	–	TA	–	SII VCN • 0 ~ 6553.5												
0x0841	2114	3P/4P	R	%	FLOAT32	–	TA	–	SII voltage unbalance rate • 0 ~ 100.0												
0x0BB9	3002	ALL	R/W	V	FLOAT32	–	TA	–	Source rated voltage <table border="1" style="margin-left: 20px;"> <thead> <tr> <th>Product series</th> <th>Pole number</th> <th>Rated voltage</th> <th>Rated voltage range in HMI</th> </tr> </thead> <tbody> <tr> <td>Frame 100</td> <td>2P</td> <td>220 V</td> <td>220 V/ 230 V/ 240 V/ 250 V</td> </tr> <tr> <td>Frame 100 and 160</td> <td>3P/4P</td> <td>380–440 V</td> <td>380 V/ 400 V/ 415 V/ 440 V</td> </tr> </tbody> </table>	Product series	Pole number	Rated voltage	Rated voltage range in HMI	Frame 100	2P	220 V	220 V/ 230 V/ 240 V/ 250 V	Frame 100 and 160	3P/4P	380–440 V	380 V/ 400 V/ 415 V/ 440 V
Product series	Pole number	Rated voltage	Rated voltage range in HMI																		
Frame 100	2P	220 V	220 V/ 230 V/ 240 V/ 250 V																		
Frame 100 and 160	3P/4P	380–440 V	380 V/ 400 V/ 415 V/ 440 V																		

Address	Register	Pole number	R/W	Unit	Type	Range	TA	Bit	Description								
									<table border="1"> <tr> <td>Frame 250, 630 and 800</td> <td>3P/4P</td> <td>208–240 V</td> <td>208 V/ 220 V/ 230 V/ 240 V</td> </tr> <tr> <td>Frame 235, 630, 800 and 1A</td> <td>3P/4P</td> <td>380–440 V</td> <td>380 V/ 400 V/ 415 V/ 440 V</td> </tr> </table>	Frame 250, 630 and 800	3P/4P	208–240 V	208 V/ 220 V/ 230 V/ 240 V	Frame 235, 630, 800 and 1A	3P/4P	380–440 V	380 V/ 400 V/ 415 V/ 440 V
Frame 250, 630 and 800	3P/4P	208–240 V	208 V/ 220 V/ 230 V/ 240 V														
Frame 235, 630, 800 and 1A	3P/4P	380–440 V	380 V/ 400 V/ 415 V/ 440 V														
0x0BBB	3004	ALL	R/W	Hz	FLOAT32	–	TA	–	Source rated frequency <ul style="list-style-type: none"> <li>• 50 or 60</li> </ul>								
0x0BBD	3006	ALL	R	ENUM	ENUM	–	TA	–	Source neutral position <ul style="list-style-type: none"> <li>• 0 = End of phase sequence</li> <li>• 1 = Start of phase sequence</li> </ul>								
0x0BC1	3010	ALL	R/W	ENUM	ENUM	–	TA	–	Enable abnormal frequency transfer <ul style="list-style-type: none"> <li>• 0 = Disable</li> <li>• 1 = Enable</li> </ul>								
0x0BC2	3011	ALL	R/W	numerical	FLOAT32	–	TA	–	SI under frequency start/Drop-out threshold percent <ul style="list-style-type: none"> <li>• 80 ~ 98%</li> </ul>								
0x0BC4	3013	ALL	R/W	numerical	FLOAT32	–	TA	–	SI under frequency reset/Pick-up threshold percent <ul style="list-style-type: none"> <li>• Max [85, dropout + Fgap] ~ 100%</li> </ul>								
0x0BC6	3015	ALL	R/W	numerical	FLOAT32	–	TA	–	SII under frequency start/Drop-out threshold percent <ul style="list-style-type: none"> <li>• 80 ~ 98%</li> </ul>								
0x0BC8	3017	ALL	R/W	numerical	FLOAT32	–	TA	–	SII under frequency reset/pick-up threshold percent <ul style="list-style-type: none"> <li>• Max [85, dropout + Fgap] ~ 100%</li> </ul>								
0x0BCA	3019	ALL	R/W	numerical	FLOAT32	–	TA	–	SI over frequency start/Drop-out threshold percent <ul style="list-style-type: none"> <li>• 101 ~ 120%</li> </ul>								
0x0BCC	3021	ALL	R/W	numerical	FLOAT32	–	TA	–	SI over frequency reset/Pick-up threshold percent <ul style="list-style-type: none"> <li>• 100 ~ min [115%, dropout - Fgap]</li> </ul>								
0x0BCE	3023	ALL	R/W	numerical	FLOAT32	–	TA	–	SII over frequency start/Drop-out threshold percent <ul style="list-style-type: none"> <li>• 101 ~ 120%</li> </ul>								
0x0BD0	3025	ALL	R/W	numerical	FLOAT32	–	TA	–	SII over frequency reset/pick-up threshold percent <ul style="list-style-type: none"> <li>• 100 ~ min [115%, dropout - Fgap]</li> </ul>								
0x0BD3	3028	ALL	R/W	numerical	FLOAT32	–	TA	–	SI under voltage start/Drop-out threshold percent <ul style="list-style-type: none"> <li>• 70 ~ 95%</li> </ul>								
0x0BD5	3030	ALL	R/W	numerical	FLOAT32	–	TA	–	SI under voltage reset/Pick-up threshold percent <ul style="list-style-type: none"> <li>• Max [85, dropout + Vgap] ~ 100%</li> </ul>								
0x0BD7	3032	ALL	R/W	numerical	FLOAT32	–	TA	–	SII under voltage start/Drop-out threshold percent <ul style="list-style-type: none"> <li>• 70 ~ 95%</li> </ul>								
0x0BD9	3034	ALL	R/W	numerical	FLOAT32	–	TA	–	SII under voltage reset/pick-up threshold percent <ul style="list-style-type: none"> <li>• Max [85, dropout + Vgap] ~ 100%</li> </ul>								
0x0BDB	3036	ALL	R/W	ENUM	ENUM	–	TA	–	Enable over voltage transfer <ul style="list-style-type: none"> <li>• 0 = Disable</li> <li>• 1 = Enable</li> </ul>								

Address	Register	Pole number	R/W	Unit	Type	Range	TA	Bit	Description
0x0BDC	3037	ALL	R/W	numerical	FLOAT32	–	TA	–	SI over voltage start/Drop-out threshold percent • 105 ~ 135%
0x0BDE	3039	ALL	R/W	numerical	FLOAT32	–	TA	–	SI over voltage reset/Pick-up threshold percent • 100 ~ min [115%, dropout - Vgap]
0x0BE0	3041	ALL	R/W	numerical	FLOAT32	–	TA	–	SII over voltage start/Drop-out threshold percent • 105 ~ 135%
0x0BE2	3043	ALL	R/W	numerical	FLOAT32	–	TA	–	SII over voltage reset/Pick-up threshold percent • 100 ~ min [115%, dropout - Vgap]
0x0BE4	3045	3P/4P	R/W	ENUM	ENUM	–	TA	–	Enable voltage unbalance • 0 = Disable • 1 = Enable
0x0BE5	3046	3P/4P	R/W	numerical	FLOAT32	–	TA	–	SI unbalance threshold • 2 ~ 30%
0x0BE7	3048	3P/4P	R/W	numerical	FLOAT32	–	TA	–	SII unbalance threshold • 2 ~ 30%
0x0BE9	3050	4P	R/W	ENUM	ENUM	–	TA	–	Enable phase sequence warning • 0 = Disable • 1 = Enable
0x0BEA	3051	4P	R	ENUM	ENUM	–	TA	–	Source phase sequence • 0 = 1-2-3 (ro)
0x0BEF	3056	ALL	R/W	ENUM	ENUM	–	TA	–	Source priority • 1 = Source I is N and Source II is A • 2 = Source I is A and Source II is N
0x0BF0	3057	ALL	R/W	ENUM	ENUM	–	TA	–	Source usage • 1 = U-U • 2 = U-G
0x0BF1	3058	ALL	R/W	ENUM	ENUM	–	TA	–	Auto transfer mode • 0 = auto return • 1 = non-return (IEC) / mutual standby (China) • 2 = manual return
0x0BF2	3059	ALL	R/W	s	FLOAT32	–	TA	–	N to A confirmation transfer delay T2 • 0 ~ 1800
0x0BF4	3061	ALL	R/W	s	FLOAT32	–	TA	–	A to N confirmation transfer delay T6 • 0 ~ 3600
0x0BF6	3063	ALL	R/W	s	FLOAT32	–	TA	–	Center-Off time delay T4 • 0 ~ 30
0x0BF8	3065	ALL	R/W	s	FLOAT32	–	TA	–	Generator start delay T7 • 0 ~ 120
0x0BFA	3067	ALL	R/W	s	FLOAT32	–	TA	–	Generator stop delay T9 • 0 ~ 3600
0x0BFC	3069	ALL	R/W	ENUM	ENUM	–	TA	–	Enable genset start fail warning • 0 = Disable • 1 = Enable
0x0BFD	3070	4P	R/W	ENUM	ENUM	–	TA	–	Enable neutral position wrong warning • 0 = Disable • 1 = Enable

Address	Register	Pole number	R/W	Unit	Type	Range	TA	Bit	Description
0x0BFE	3071	4P	R/W	ENUM	ENUM	–	TA	–	Enable neutral loss warning • 0 = Disable • 1 = Enable
0x0BFF	3072	ALL	R/W	ENUM	ENUM	–	TA	–	Onload test timer T13 limited • 0 = Unlimited • 1 = Limited
0x0C00	3073	ALL	R/W	s	FLOAT32	–	TA	–	Onload test timer T13 time period • 1 ~ 1800
0x0C02	3075	ALL	R/W	ENUM	ENUM	–	TA	–	Offload test timer T14 limited • 0 = Unlimited • 1 = Limited
0x0C03	3076	ALL	R/W	s	FLOAT32	–	TA	–	Offload test timer T14 time period • 1 ~ 1800
0x0C05	3078	ALL	R/W	ENUM	ENUM	–	TA	–	Test type from DI Test module config • 0 = Onload test • 1 = Offload test
0x0C1B	3100	ALL	R	Hz	FLOAT32	–	TA	–	SI under frequency start/Drop-out threshold value • nominal freq * percent
0x0C1D	3102	ALL	R	Hz	FLOAT32	–	TA	–	SI under frequency reset/Pick-up threshold value • nominal freq * percent
0x0C1F	3104	ALL	R	Hz	FLOAT32	–	TA	–	SII under frequency start/Drop-out threshold value • nominal freq * percent
0x0C21	3106	ALL	R	Hz	FLOAT32	–	TA	–	SII under frequency reset/Pick-up threshold value • nominal freq * percent
0x0C23	3108	ALL	R	Hz	FLOAT32	–	TA	–	SI over frequency start/Drop-out threshold value • nominal freq * percent
0x0C25	3110	ALL	R	Hz	FLOAT32	–	TA	–	SI over frequency reset/Pick-up threshold value • nominal freq * percent
0x0C27	3112	ALL	R	Hz	FLOAT32	–	TA	–	SII over frequency start/Drop-out threshold value • nominal freq * percent
0x0C29	3114	ALL	R	Hz	FLOAT32	–	TA	–	SII over frequency reset/Pick-up threshold value • nominal freq * percent
0x0C2B	3116	ALL	R	V	FLOAT32	–	TA	–	SI under voltage start/Drop-out threshold value • nominal freq * percent
0x0C2D	3118	ALL	R	V	FLOAT32	–	TA	–	SI under voltage reset/Pick-up threshold value • nominal freq * percent
0x0C2F	3120	ALL	R	V	FLOAT32	–	TA	–	SII under voltage start/Drop-out threshold value • nominal freq * percent
0x0C31	3122	ALL	R	V	FLOAT32	–	TA	–	SII under voltage reset/Pick-up threshold value • nominal freq * percent
0x0C33	3124	ALL	R	V	FLOAT32	–	TA	–	SI over voltage start/Drop-out threshold value

Address	Register	Pole number	R/W	Unit	Type	Range	TA	Bit	Description
									<ul style="list-style-type: none"> <li>nominal freq * percent</li> </ul>
0x0C35	3126	ALL	R	V	FLOAT32	–	TA	–	SI over voltage reset/Pick-up threshold value <ul style="list-style-type: none"> <li>nominal freq * percent</li> </ul>
0x0C37	3128	ALL	R	V	FLOAT32	–	TA	–	SII over voltage start/Drop-out threshold value <ul style="list-style-type: none"> <li>nominal freq * percent</li> </ul>
0x0C39	3130	ALL	R	V	FLOAT32	–	TA	–	SII over voltage reset/Pick-up threshold value <ul style="list-style-type: none"> <li>nominal freq * percent</li> </ul>
0x0DAB	3500	ALL	R	–	BOOL	–	TA	0	Genset start failure alarm validity <ul style="list-style-type: none"> <li>0 = Invalid</li> <li>1 = valid</li> </ul>
0x0DAC	3501	ALL	R	–	BOOL	–	TA	0	Genset start failure alarm <ul style="list-style-type: none"> <li>1 = Yes</li> </ul>
0x0DAD	3502	ALL	R	–	BOOL	–	TA	0	External power supply presence validity <ul style="list-style-type: none"> <li>0 = Invalid</li> <li>1 = valid</li> </ul>
0x0DAE	3503	ALL	R	–	BOOL	–	TA	0	External power supply presence <ul style="list-style-type: none"> <li>1 = Presence</li> </ul>
0x0DAF	3504	ALL	R	–	BOOL	–	TA	0	Onload test failure alarm validity <ul style="list-style-type: none"> <li>0 = Invalid</li> <li>1 = valid</li> </ul>
0x0DAF	3504	ALL	R	–	BOOL	–	TA	1	Offload test failure alarm validity <ul style="list-style-type: none"> <li>0 = Invalid</li> <li>1 = valid</li> </ul>
0x0DB0	3505	ALL	R	–	BOOL	–	TA	0	Onload test failure alarm <ul style="list-style-type: none"> <li>1 = Yes</li> </ul>
0x0DB0	3505	ALL	R	–	BOOL	–	TA	1	Offload test failure alarm <ul style="list-style-type: none"> <li>1 = Yes</li> </ul>
0x0DB1	3506	ALL	R	ENUM	ENUM	–	TA	–	Unexpected position alarm <ul style="list-style-type: none"> <li>0 = No alarm</li> <li>1 = When transferring to A position</li> <li>2 = When transferring to N position</li> <li>3 = When transferring to off position</li> <li>4 = When transferring to invalid position</li> <li>5 = When in non-handle mode</li> </ul>
0x0FBD	4030	ALL	R	numerical	UINT32	–	TA	–	Total Transfer count (no handle count) <ul style="list-style-type: none"> <li>0 ~ 65535</li> </ul>
0x0FBF	4032	ALL	R	numerical	UINT32	–	TA	–	Total Transfer failure count <ul style="list-style-type: none"> <li>0 ~ 65535</li> </ul>
0x0FC1	4034	ALL	R	numerical	UINT32	–	TA	–	Too fast transfer counter <ul style="list-style-type: none"> <li>0 ~ 65535</li> </ul>
0x0FD1	4050	ALL	R	numerical	UINT32	–	TA	–	Configuration changed count <ul style="list-style-type: none"> <li>0 ~ 4294967295</li> </ul>
0x01389	5002	ALL	R	ENUM	ENUM	–	TA	–	Force to off function supported <ul style="list-style-type: none"> <li>1 = Supported</li> </ul>
0x0138A	5003	ALL	R	ENUM	ENUM	–	TA	–	Force to off status <ul style="list-style-type: none"> <li>0 = Inactive</li> </ul>

Address	Register	Pole number	R/W	Unit	Type	Range	TA	Bit	Description
									<ul style="list-style-type: none"> <li>• 1 = Active</li> </ul>
0x0138B	5004	ALL	R	ENUM	ENUM	–	TA	–	Inhibit function supported <ul style="list-style-type: none"> <li>• 1 = Supported</li> </ul>
0x0138C	5005	ALL	R	ENUM	ENUM	–	TA	–	Inhibit status <ul style="list-style-type: none"> <li>• 0 = Inactive</li> <li>• 1 = Active</li> </ul>
0x0138D	5006	ALL	R	ENUM	ENUM	–	TA	–	Voluntary remote control function supported <ul style="list-style-type: none"> <li>• 1 = Supported</li> </ul>
0x0138E	5007	ALL	R	ENUM	ENUM	–	TA	–	Voluntary remote control status <ul style="list-style-type: none"> <li>• 0 = Inactive</li> <li>• 1 = to_N</li> <li>• 2 = to_A</li> </ul>
0x0138F	5008	ALL	R	ENUM	ENUM	–	TA	–	Fire function supported <ul style="list-style-type: none"> <li>• 1 = Supported</li> </ul>
0x01390	5009	ALL	R	ENUM	ENUM	–	TA	–	Fire status <ul style="list-style-type: none"> <li>• 0 = Inactive</li> <li>• 1 = Active</li> </ul>
0x01391	5010	ALL	R	ENUM	ENUM	–	TA	–	Test status function supported <ul style="list-style-type: none"> <li>• 1 = Supported</li> </ul>
0x01392	5011	ALL	R	ENUM	ENUM	–	TA	–	Test status <ul style="list-style-type: none"> <li>• 0 = Inactive</li> <li>• 1 = Active</li> </ul>
0x01393	5012	ALL	R	ENUM	ENUM	–	TA	–	HMI transfer function supported <ul style="list-style-type: none"> <li>• 1 = Supported</li> </ul>
0x01394	5013	ALL	R	ENUM	ENUM	–	TA	–	HMI transfer status (local control) <ul style="list-style-type: none"> <li>• 0 = Inactive</li> <li>• 1 = Active</li> </ul>
0x01395	5014	ALL	R	ENUM	ENUM	–	TA	–	Comm control function supported <ul style="list-style-type: none"> <li>• 0 = unsupported</li> <li>• 1 = supported</li> </ul>
0x01396	5015	ALL	R	ENUM	ENUM	–	TA	–	Transfer by comm status <ul style="list-style-type: none"> <li>• 0 = Inactive</li> <li>• 1 = to_N</li> <li>• 2 = to_A</li> <li>• 3 = to_off</li> </ul>
0x01397	5016	ALL	R	ENUM	ENUM	–	TA	–	Test result <ul style="list-style-type: none"> <li>• 0 = last runtime result pass</li> <li>• 1 = last runtime result failure</li> <li>• 2 = onload testing</li> <li>• 3 = offload testing</li> </ul>
0x0144F	5200	ALL	R/W	s	FLOAT32	–	TA	–	Load shedding time delay T8 <ul style="list-style-type: none"> <li>• 0 ~ 15</li> </ul>
0x0176F	6000	ALL	R/W	IE-C87-0-5-4	DATE-TIME	–	TA	–	System time <ul style="list-style-type: none"> <li>• datetime IEC870-5-4</li> </ul>
0x01773	6004	ALL	R	ENUM	ENUM	–	TA	–	Pole number <ul style="list-style-type: none"> <li>• 2 = 2P</li> <li>• 3 = 3P</li> <li>• 4 = 4P</li> </ul>

Address	Register	Pole number	R/W	Unit	Type	Range	TA	Bit	Description
0x01783	6020	ALL	R	numerical	UINT16	–	TA	–	Product identifier <ul style="list-style-type: none"> <li>• 19750 for Frame 100 and 160</li> <li>• 19751 for Frame 250, 630 and 800</li> </ul>
0x01784	6021	ALL	R	STRING	STRING	–	TA	–	Vendor name <ul style="list-style-type: none"> <li>• Schneider Electric</li> </ul>
0x0178E	6031	ALL	R	STRING	STRING	–	TA	–	Product family <ul style="list-style-type: none"> <li>• TransferPacT Switch</li> </ul>
0x01797	6040	ALL	R	STRING	STRING	–	TA	–	Product range <ul style="list-style-type: none"> <li>• TransferPacT</li> </ul>
0x017A1	6050	ALL	R	STRING	STRING	–	TA	–	Product model <ul style="list-style-type: none"> <li>• TSE - Active Auto</li> <li>• TSE - Auto</li> <li>• TSE - WTS</li> <li>• TSE - Manual</li> </ul>
0x017A9	6058	ALL	R	STRING	STRING	–	TA	–	Product code CR num
0x017B1	6066	ALL	R	STRING	STRING	–	TA	–	Serial number PP-YY-ww-D-II-xxxx
0x017BB	6076	ALL	R/W	STRING	STRING	–	TA	–	User application name "User app name"
0x017DB	6108	ALL	R/W	STRING	STRING	–	TA	–	Product capability "Product Capability"
0x017E7	6120	ALL	R	STRING	STRING	–	TA	–	FW version xxx.yyy.zzz
0x017ED	6126	ALL	R	STRING	STRING	–	TA	–	Hardware version xxx.yyy.zzz
0x017F3	6132	ALL	R	ENUM	ENUM	–	TA	–	Current running image type <ul style="list-style-type: none"> <li>• 0 = Exploit</li> <li>• 1 = Fct</li> <li>• 2 = Upgrader</li> </ul>
0x017F4	6133	ALL	R	STRING	STRING	–	TA	–	Vendor URL www.se.com
0x02324	8997	ALL	R	ENUM	ENUM	–	TA	–	Enable transfer by comm <ul style="list-style-type: none"> <li>• 0 = disable</li> <li>• 1 = enable</li> </ul>
0x02325	8998	ALL	R	ENUM	ENUM	–	TA	–	Check whether can do comm control <ul style="list-style-type: none"> <li>• 0 = cannot do comm control</li> <li>• 1 = can do comm control</li> </ul>
0x02326	8999	ALL	R	ENUM	ENUM	–	TA	–	Comm control method <ul style="list-style-type: none"> <li>• 0 = simple control</li> <li>• 1 = advance control</li> </ul>
0x02327	9000	ALL	W	ENUM	ENUM	–	TA	–	Transfer by comm request <ul style="list-style-type: none"> <li>• 0 = exit</li> <li>• 1 = transfer to N</li> <li>• 2 = transfer to A</li> <li>• 3 = transfer to Off</li> </ul>
0x02328	9001	ALL	R	ENUM	ENUM	–	TA	–	Enable test by comm <ul style="list-style-type: none"> <li>• 0 = disable</li> <li>• 1 = enable</li> </ul>

Address	Register	Pole number	R/W	Unit	Type	Range	TA	Bit	Description
0x02329	9002	ALL	W	ENUM	ENUM	–	TA	–	Test by comm request <ul style="list-style-type: none"> <li>• 0 = test inactive (exit)</li> <li>• 1 = onload test active</li> <li>• 2 = offload test active</li> </ul>
0x0270F	10000	ALL	R	numerical	UINT16	–	TA	–	Event log version 0-65535
0x02710	10001	ALL	R	numerical	UINT16	–	TA	–	Event log type 0-65535
0x02711	10002	ALL	R	numerical	UINT16	–	TA	–	Event log queue size (log number) 0-1000
0x02712	10003	ALL	R	numerical	UINT16	–	TA	–	Event log current log number in queue 0-1000
0x02713	10004	ALL	R	numerical	UINT16	–	TA	–	Event log latest index 0-65535
0x02714	10005	ALL	R	T-I086	TI086	–	TA	–	Event log content
0x09C3F	40000	ALL	R	numerical	UINT16	–	TA	–	System log version 0-65535
0x09C40	40001	ALL	R	numerical	UINT16	–	TA	–	System log type 0-65535
0x09C41	40002	ALL	R	numerical	UINT16	–	TA	–	System log queue size (log number) 0-1000
0x09C42	40003	ALL	R	numerical	UINT16	–	TA	–	System log current log number in queue 0-1000
0x09C43	40004	ALL	R	numerical	UINT16	–	TA	–	System log latest index 0-65535
0x09C44	40005	ALL	R	T-I086	TI086	–	TA	–	System log content

# Alarms and Troubleshooting

## What's in This Chapter

Overview .....	213
Alarm .....	214
Warning.....	217
Event Logs .....	224

## Overview

There are two types of alarms for ATSE and RSTE:

- Alarm
- Warning

Alarm Type	Description
Alarm	Indicates the controller detects a critical error or switch mechanism error. Do not perform manual operation when ATSE is in alarm state. Contact field service first, and/or check the root cause according to the <i>Alarm Message</i> , page 215 to clear and acknowledge the alarm.
Warning	Indicates the occurrence of unsuccessful testing, Genset start or detected failure.

## Alarm

When an alarm is triggered, it will ignore all other alarms and the alarm LED shall always be ON until it is acknowledged.

**NOTE:** The Modbus will provide the other alarms continuously.

The following are the methods to clear/acknowledge alarms:

- For TransferPacT Remote, cancel the alarm by resetting RTSE at site.
- For Automatic HMI, put the dielectric switch to TEST position and then put it back to RUN to restart the controller to clear/acknowledged the alarm.
- For Active Automatic HMI, when an alarm is triggered, the HMI will pop-up alarm screen. There will be a ▲ icon displayed on the page to indicate that there is an active alarm.

Perform the following procedure to check and clear the alarm on Active Automatic:

1. Select the **Set & Operate** page and press **OK**.

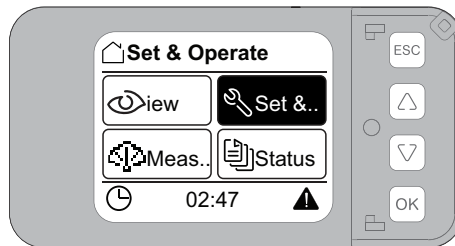

2. Enter the password to open the Set & Operate page.
3. Select **Operations** sub-page.

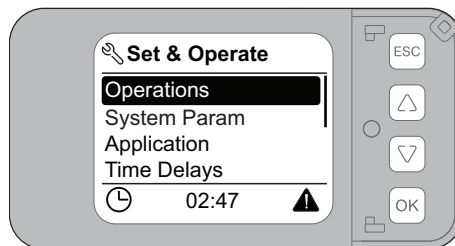

4. Press **Down** button and select **Alarm Ack**.

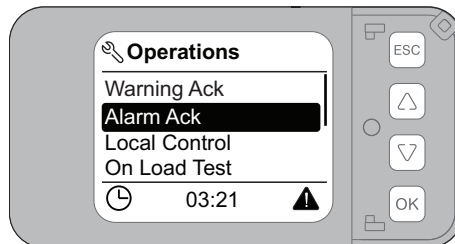

5. Click **OK** on the screen.

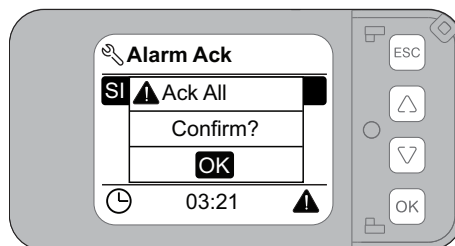

**NOTE:** A password is required to open the Set & Operate page.

## Alarm Message

Alarm Code	Alarm Message	LCD display
1	Position alarm: transfer to A error	Transfer to A failed
2	Position alarm: transfer to N error	Transfer to N failed
3	Position alarm: transfer to OFF error	Transfer to OFF failed
4	Position alarm: transfer to invalid position	Invalid position
5	Position Alarm: Internal error	Internal error
6	Position alarm: unexpected position	Unexpected position
10	Source I phase rotation error	SI phase rotation
11	Source II phase rotation error	SII phase rotation
12	Unsupported device RS alarm	Unsupported device RS

### Position Alarm: Transfer to A Error

- Event code: 1
- Type of event: Alarm.
- Default: Always enable.
- Description: When TSE cannot transfer to replacement, an alarm will be raised.
- Cause: Stack of mechanism or failure of electronic components.
- Diagnosis and repair: Contact field service.

### Position Alarm: Transfer to N Error

- Event code: 2.
- Type of event: Alarm.
- Default: Always enable.
- Description: When the TSE cannot transfer to normal, an alarm will be raised.
- Cause: Stack of mechanism or failure of electronic components.
- Diagnosis and repair: Contact field service.

### Position Alarm: Transfer to Off Error

- Event code: 3.
- Type of event: Alarm.
- Default: Always enable.
- Description: When the TSE cannot transfer to off position, an alarm will be raised.
- Cause: Stack of mechanism or failure of electronic components.
- Diagnosis and repair: Contact field service..

### Position Alarm: Transfer to Invalid Position

- Event code: 4.
- Type of event: Alarm.

- Default: Always enable.
- Description: When TSE transfer to frequently, an alarm will be raised.
- Cause: Unexpected operating or controller failure.
- Diagnosis and repair: Contact field service..

## Position Alarm: Internal Error

- Event code: 5
- Type of event: Alarm.
- Default: Always enable.
- Description: When TSE cannot transfer to off position, an alarm will be raised.
- Cause: Stack of mechanism or failure of electronic components.
- Diagnosis and repair: Contact field service..

## Position Alarm: Unexpected Position

- Event code: 6
- Type of event: Alarm.
- Default: Always enable.
- Description: When micro-switch all closed, the TSE may lead short circuit of two sources. an alarm will be raised.
- Cause: Welding issue of failure of micro-switch.
- Diagnosis and repair: Contact field service.

## Source I or II Phase Rotation Failure

- Event code: 10,11.
- Type of event: Alarm.
- Default: Enabled (Disabled in China market)
- Description: When there is phase rotation such as from A-B-C move to C-B-A, an alarm will be raised if this function is enabled.
- Cause: Wrong installing when first connection of main circuit or reform the main connections.
- Diagnosis and repair: Double check the phase sequence of main circuit or contact field service.

## Unsupported Device RS Alarm

- Event code: 12.
- Type of event: Alarm.
- Default: Always enabled.
- Description: If a rotary switch is connected to a frame 250, 630 or 800 TSE with operation voltage from 208-250 V, an alarm will be raised.
- Cause: Rotary switch is not supported on the frame 250, 630 or 800 TSE with operation voltage from 208-250 V.
- Diagnosis and repair: Remove the rotary switch if it's connected or contact field service.

# Warning

When the warning is triggered for event codes, such as 30,31,40,41,50,51,52 and 53, the HMI will pop-up the alarm screen. The green source LED blinks OFF or ON for event codes such as 54,55,70,71,72,73,74,75,76,77,78,79,80 and 81. The event code list and display method are shown in the below table.

The  icon is displayed on the page to indicate an active warning.

If the warning is triggered, it will display the latest warning and previous alarms are overwritten on the HMI. The log will be recorded.

Perform the following procedure to check and clear the alarm:

1. Select the **Set & Operate** page and press **OK**.

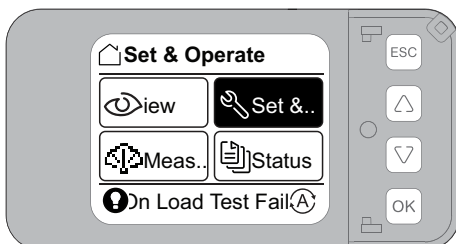

2. Enter the password to open the Set & Operate page.
3. Select **Operations** sub-page.

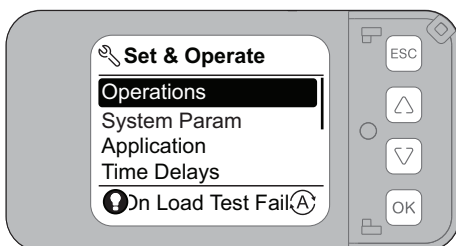

4. Press **Down** button and select **Warning Ack**.

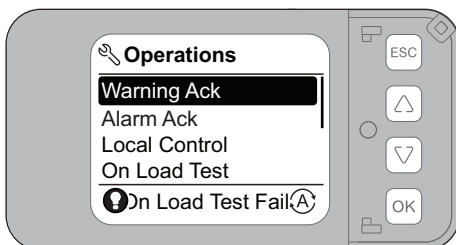

5. Click **OK** on the screen.

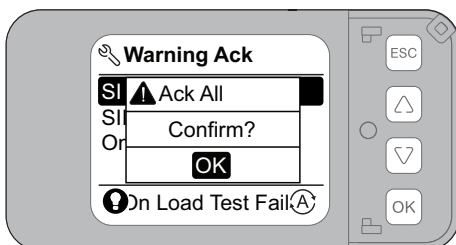

The warning will not inhibit the transfer functions for the below event codes:

## List of Event Codes

Alarm code	Alarm message	LCD display method	LED display method
30	Genset invalid	Bottom bar	None
31	Genset start failure	Bottom bar	None
40	On load test failure	Bottom bar	None
41	Off load test failure	Bottom bar	None
42	On load test success	Bottom bar	None
43	Off load test success	Bottom bar	None
50	SI unbalance warning	Bottom bar	None
51	SII unbalance warning	Bottom bar	None
52	SI neutral position wrong warning	Bottom bar	None
53	SII neutral position wrong warning	Bottom bar	None
54	SI neutral loss warning	None	LED source state blinking
55	SII neutral loss warning	None	LED source state blinking
70	SI under voltage	None	LED source state blinking
71	SII under voltage	None	LED source state blinking
72	SI over voltage	None	LED source state blinking
73	SII over voltage	None	LED source state blinking
74	SI no voltage	None	LED source state off
75	SII no voltage	None	LED source state off
76	SI under frequency	None	LED source state blinking
77	SII under frequency	None	LED source state blinking
78	SI over frequency	None	LED source state blinking
79	SII over frequency	None	LED source state blinking
80	SI all recover	None	LED source state on
81	SII all recover	None	LED source state on

## SI Unbalance Warning

- Event code: 50.
- Type of event: Warning.
- Default: Disable.
- Description: If unbalance of voltage occurs over the drop-out rate of threshold (5% as default) when SI is connected, a warning will be raised.
- Cause: Too many single-phase loads or poor quality of power supply environment.

- Diagnosis and repair: Set the different value of imbalance rate or contact field service.

## SII Unbalance Warning

- Event code: 51.
- Type of event: Warning.
- Default: Disable.
- Description: If unbalance of voltage occurs over the drop-out rate of threshold (5% as default) when SII is connected, a warning will be raised.
- Cause: Too many single-phase loads or poor quality of power supply environment.
- Diagnosis and repair: Set the different value of imbalance rate or contact field service.

## Generator Invalid

- Event code: 30.
- Type of event: Warning.
- Default: Always disable.
- Description: The sudden loss of an alternate source will lead to a warning.
- Cause: Genset is not connected well or some failure on Genset started
- Diagnosis and repair: Contact field service.

## Generator Start Failure

- Event code: 31.
- Type of event: Warning.
- Default: Disable.
- Description: After sending the Genset start signal, controller will wait a time T10 duration until Genset is ready.
  - The ATSE will rise the Genset alarm, if Genset is not started within T10 timer is ended (if enabled).
  - The ATSE shall reset the Genset alarm, when the A source is in range or when the N source is in range.
  - The time delay is only available when there is external power.
- Cause: Genset is not connected well or some failure on Genset started.
- Diagnosis and repair: Contact field service.

## On Load/Off Load Test Failure

- Event code: 40, 41
- Type of event: Warning.
- Default: Always enabled.
- Description: If on load or off load test is failed or interrupted, a warning will be raised.
- Cause: Product failure or external interruption
- Diagnosis and repair: Contact field service.

## SI or SII Neutral Position Wrong Warning

- Event code: 52, 53
- Type of event: Warning.
- Default: Always enabled in IEC market, disabled in China market.
- Description: If sequence of neutral is not connected as set value, a warning will be raised.
- Cause: Wrong connection of neutral or wrong settings.
- Diagnosis and repair: Set the new neutral sequence or contact field service.

## SI or SII Neutral Loss Warning

- Event code: 54, 55
- Type of event: Warning.
- Default: Disabled.
- Description: If unbalance rate of voltage occurs over 20% when source is connected, a warning will be raised.
- Cause: Miss connection or disconnection caused by interior or exterior impacts of neutral line..
- Diagnosis and repair: correct the connection or contact field service.

## SI Under Voltage

- Event code: 70.
- Type of event: Event.
- Default: Always enable.
- Description: When there is under voltage on SI, an event log will be recorded.

## SII Under Voltage

- Event code: 71.
- Type of event: Event.
- Default: Always enable.
- Description: When there is under voltage on SII, an event log will be recorded.

## SI Over Voltage

- Event code: 72.
- Type of event: Event.
- Default: Disabled.
- Description: When there is over voltage on SI, an event log will be recorded.

## SII Over Voltage

- Event code: 73.
- Type of event: Event.
- Default: Disabled.
- Description: When there is over voltage on SII, an event log will be recorded.

## SI No Voltage

- Event code: 74.
- Type of event: Event.
- Default: Always enable.
- Description: When there is source failure on SI, an event log will be recorded.

## SII No Voltage

- Event code: 75.
- Type of event: Event.
- Default: Always enable.
- Description: When there is source failure on SII, an event log will be recorded.

## SI Under Frequency

- Event code: 76.
- Type of event: Event.
- Default: Disable
- Description: When there is Under frequency on SI, an event log will be recorded.

## SII Under Frequency

- Event code: 77.
- Type of event: Event.
- Default: Disable
- Description: When there is Under frequency on SII, an event log will be recorded.

## SI Over Frequency

- Event code: 78.
- Type of event: Event.
- Default: Disable
- Description: When there is Under frequency on SI, an event log will be recorded.

## SII Over Frequency

- Event code: 79.
- Type of event: Event.
- Default: Disable
- Description: When there is Under frequency on SII, an event log will be recorded.

## SI All Recover

- Event code: 80.
- Type of event: Event.
- Default: Always enable.
- Description: When SI recover to normal, an event log will be recorded.

## SII All Recover

- Event code: 81.
- Type of event: Event.
- Default: Always enable.
- Description: When SII recover to normal, an event log will be recorded.

## Event Logs

TransferPacT ATSE can record maximum up to 99 events of the event logs. If it exceeds the events limit, the latest logs will overwrite the previous event logs. The limit of event logs on LCD and Modbus are:

- LCD can only display the last 20 events.
- Modbus can display all the events.

Perform the following procedure to check the event logs:

1. Select the **Status** page from Home page and press **OK** button.

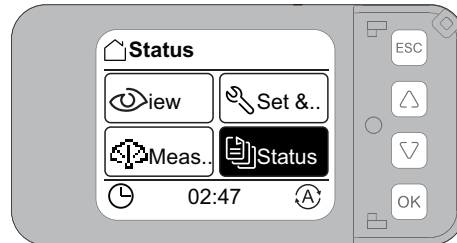

2. Select **Event Logs** option and press **OK** button.

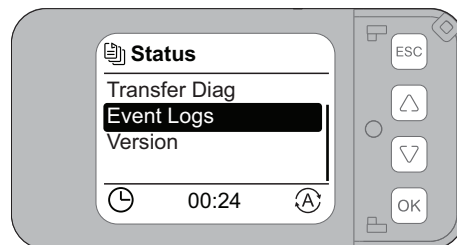

3. Select **SI Back To Normal**.

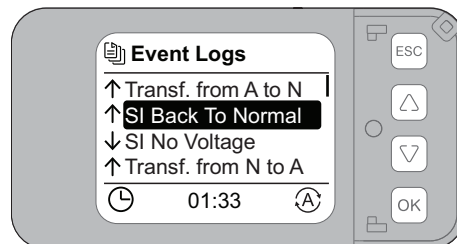

4. Press **OK** button to check the selected event log.

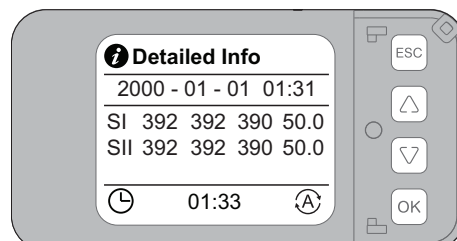
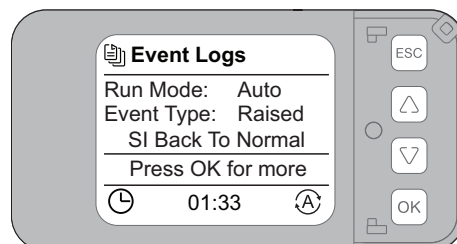

## Event Logs Page Description

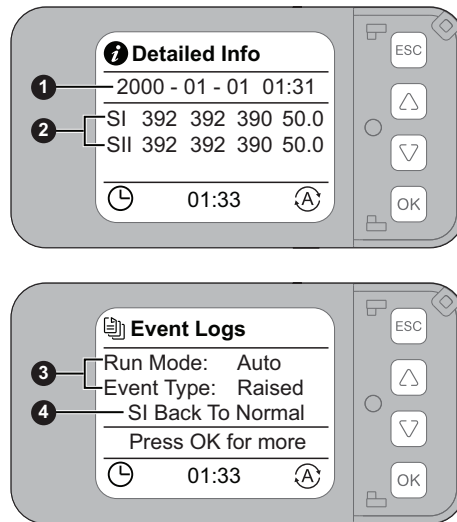

Label	Description
1	Time of events. <b>NOTE:</b> Without any time calibration or external DC 24 V, after long terms shut down of controller, the timer may show wrong.
2	The source status during the events.
3	Code of events.
4	Transfer mode during the events.

**NOTE:** Event logs cannot be reset.

## List of Event Logs

Event Code	LCD Display
1	Position alarm: Transfer to A Failed
2	Position alarm: Transfer to N Failed
3	Position alarm: Transfer to OFF Failed
4	Position alarm: Transfer to Invalid Position
5	Position Alarm: Internal Error
6	Position alarm: Unexpected position
10	SI Phase Rotation Error
11	SII Phase Rotation Error
12	Unsupported Device RS Alarm
30	Genset Invalid
31	Genset Start Failure
40	On Load Test Failure
41	Off Load Test Failure
42	On Load Test Success
43	Off Load Test Success
50	SI Unbalance Warning
51	SII Unbalance Warning
52	SI Neutral Position Wrong Warning
53	SII Neutral Position Wrong Warning
54	SI Neutral Loss Warning
55	SII Neutral Loss Warning
70	SI Undervoltage
71	SII Undervoltage
72	SI Overvoltage
73	SII Overvoltage
74	SI No Voltage
75	SII No Voltage
76	SI Underfrequency
77	SII Underfrequency
78	SI Overfrequency
79	SII Overfrequency
80	SI All Recover
81	SII All Recover
100	SI Voltage over 500 V
101	SII Voltage over 500 V
120	Transfer from N to A
121	Transfer from A to N
122	Transfer from N to O
123	Transfer from A to O
124	Transfer from O to N
125	Transfer from O to A
140	Load Shedding Output

<b>Event Code</b>	<b>LCD Display</b>
141	Genset Start
142	Genset Stop
143	Alarm Output Start
144	Alarm Output Stop
145	Force to OFF
146	Fire Start
147	Fire Stop
148	Enter Inhibit Mode
149	On Load Test
150	Off Load Test
151	Voluntary to N
152	Voluntary to A
153	Comm Transfer Exit
154	Comm Transfer to N
155	Comm Transfer to A
156	Comm Transfer to OFF
200	Operation Mode Changed

# Dielectric Test

## Dielectric Test Switch

### NOTICE

#### HAZARD OF EQUIPMENT DAMAGE

- Before dielectric test, put the dielectric switch to test position to turn off the controller.
- After the dielectric test, put the dielectric switch back to run position to power on the controller.

**Failure to follow these instructions can result in equipment damage.**

The dielectric switch on the controller is used to disconnect the controller before performing the dielectric test and install accessory. Both functions are needed to disconnect dielectric switch. The arrow position of the switch indicates whether the controller is disconnected (Test) or connected (Run) to perform the dielectric test.



Perform the following procedure for dielectric test:

1. Insert the screwdriver and rotate anti-clockwise to bring it to **Test** position.

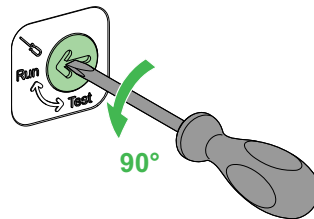

2. Perform the dielectric test once the dielectric switch is ejected.

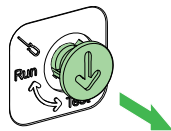

3. Insert the screwdriver and rotate the dielectric switch clockwise to bring it to **Run** position after the dielectric test.

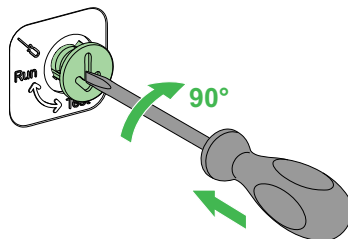

# Cybersecurity

## ***NOTICE***

### **HAZARD OF EQUIPMENT DAMAGE**

- Keep side label intact.
- Do not touch the product if side label is broken as it may defect the equipment.

**Failure to follow these instructions can result in equipment damage.**

For more information on Cybersecurity, refer to [Cybersecurity Guide](#).

## Acronyms and Terminology

Short terms	Expansion	Description
TSE	Transfer Switching Equipment	Self-acting transfer switching equipment, including all necessary sensing inputs, monitoring, and control logic for transferring operations.
ATSE	Automatic Transfer Switching Equipment	
RTSE	Remote Transfer Switching Equipment	Remote operated transfer switching equipment
MTSE	Manual Transfer Switching Equipment	Manually operated transfer switching equipment
SI	Source I	SI supply
SII	Source II	SII supply
N	Normal	Normal supply
A	Alternate	Alternate supply
E	Emergency	
O	Off position	Two powers are disconnected
Specific TSE	Specific transfer switching equipment	2/3 position dedicated designed as IEC 60947-6-1 product requirement
Derived TSE	Derived transfer switching equipment	Fulfilling requirements of other IEC 60947 product standards
Open transition	Normal transfer	The basic transfer function
In phase transition	Sync transition	Open transition but detect phase angle when re-transfer
Delayed transition	Delay transition	A programmable time delay for neutral position
Close transition	Close transition	A load transfer by momentarily paralleling both sources
Neutral overlapping	Transfer with neutral overlapping	Making before breaking and N will never be lost
Under voltage sensor		Detect the Undervoltage of power source
Over voltage sensor		Detect the Overvoltage of power source
Frequency sensor		Detect the frequency of power source
Voltage unbalance sensor		Detect the balance of power source
Phase rotation sensor		Detect the phase angle of power source
Loss of single-phase sensor		Detect the phase of power source
T2	Transfer Delay	Transfer delay
T4	Center-off Delay	Center-off delay
T6	Re-Transfer Delay	Re-Transfer Delay
T7	Genset Start Delay	Genset start delay
T8	Loadshed Delay	Loadshed delay
T9	Genset Cool Delay	Genset cool delay
T10	Genset Fail Delay	Genset fail delay
T13	On Load Test Delay	On load test delay
T14	Off Load Test Delay	Off load test delay
Power supply models		An additional power supply connection for controller
Auto-return		A working mode for ATSE controller
Non-return		A working mode for ATSE controller
Manual-return		A working mode for ATSE controller
Load shed		A signal from ATSE controller to shed the load

<b>Short terms</b>	<b>Expansion</b>	<b>Description</b>
Transfer inhibit		Override transfer orders
Genset start		A Genset start signal from controller
Fire protection		Shed the ATSE when fire signal is received
Voluntary remote control		Transfer remotely
External 24 Vdc		External power for controller/communication

Schneider Electric  
35 rue Joseph Monier  
92500 Rueil Malmaison  
France

+ 33 (0) 1 41 29 70 00

[www.se.com](http://www.se.com)

As standards, specifications, and design change from time to time, please ask for confirmation of the information given in this publication.

© 2025 Schneider Electric. All rights reserved.

DOCA0214EN-06