

Harmony BX1

User Guide

EIO0000005096_03

11/2023

Legal Information

The information provided in this document contains general descriptions, technical characteristics and/or recommendations related to products/solutions.

This document is not intended as a substitute for a detailed study or operational and site-specific development or schematic plan. It is not to be used for determining suitability or reliability of the products/solutions for specific user applications. It is the duty of any such user to perform or have any professional expert of its choice (integrator, specifier or the like) perform the appropriate and comprehensive risk analysis, evaluation and testing of the products/solutions with respect to the relevant specific application or use thereof.

The Schneider Electric brand and any trademarks of Schneider Electric SE and its subsidiaries referred to in this document are the property of Schneider Electric SE or its subsidiaries. All other brands may be trademarks of their respective owner.

This document and its content are protected under applicable copyright laws and provided for informative use only. No part of this document may be reproduced or transmitted in any form or by any means (electronic, mechanical, photocopying, recording, or otherwise), for any purpose, without the prior written permission of Schneider Electric.

Schneider Electric does not grant any right or license for commercial use of the document or its content, except for a non-exclusive and personal license to consult it on an "as is" basis.

Schneider Electric reserves the right to make changes or updates with respect to or in the content of this document or the format thereof, at any time without notice.

To the extent permitted by applicable law, no responsibility or liability is assumed by Schneider Electric and its subsidiaries for any errors or omissions in the informational content of this document, as well as any non-intended use or misuse of the content thereof.

Table of Contents

Safety Information	4
About the Book.....	5
Overview	8
Part Number.....	8
Package Contents	8
Certifications and Standards.....	8
Federal Communication Commission Radio Frequency Interference Statement - For USA.....	9
Accessories	11
Parts Identification and Functions	12
Parts Identification	12
LED Indications (Indicators Light).....	13
Specifications.....	14
General Specifications	14
Electrical Specifications.....	14
Environmental Specifications	14
Structural Specifications	15
Functional Specifications.....	15
Performance Specifications	15
Interface Specifications	16
Specifications	16
Interfaces	16
Dimensions.....	20
Installation and Wiring.....	21
Precautions for Building into an End-use Product	21
Installation Requirements	21
Installation of the Product	22
Wiring the Power Supply	23
DC Power Cord Preparation.....	23
Connecting the DC Power Cord.....	24
Power Supply Precautions	25
Grounding	26
Micro SD Card Installation	27
Cybersecurity	29
Cybersecurity Guideline	29
First System Login.....	30
Login and Password Change	30
System Recovery	31
System Recovery Tool.....	31
Maintenance	32
Regular Cleaning	32
Periodic Check Points	32
Replacing the Battery	33

Safety Information

Important Information

Read these instructions carefully, and look at the equipment to become familiar with the device before trying to install, operate, service, or maintain it. The following special messages may appear throughout this documentation or on the equipment to warn of potential hazards or to call attention to information that clarifies or simplifies a procedure.



The addition of this symbol to a “Danger” or “Warning” safety label indicates that an electrical hazard exists which will result in personal injury if the instructions are not followed.



This is the safety alert symbol. It is used to alert you to potential personal injury hazards. Obey all safety messages that follow this symbol to avoid possible injury or death.

DANGER

DANGER indicates a hazardous situation which, if not avoided, **will result in** death or serious injury.

WARNING

WARNING indicates a hazardous situation which, if not avoided, **could result in** death or serious injury.

CAUTION

CAUTION indicates a hazardous situation which, if not avoided, **could result in** minor or moderate injury.

NOTICE

NOTICE is used to address practices not related to physical injury.

Please Note

Electrical equipment should be installed, operated, serviced, and maintained only by qualified personnel. No responsibility is assumed by Schneider Electric for any consequences arising out of the use of this material.

A qualified person is one who has skills and knowledge related to the construction and operation of electrical equipment and its installation, and has received safety training to recognize and avoid the hazards involved.

About the Book

Document Scope

This manual describes the configuration and usage of Harmony BX1.

Harmony BX1 is designed to operate in an industrial environment.

Validity Note

This documentation is valid for Harmony BX1.

The characteristics of the products described in this document are intended to match the characteristics that are available on www.se.com. As part of our corporate strategy for constant improvement, we may revise the content over time to enhance clarity and accuracy. If you see a difference between the characteristics in this document and the characteristics on www.se.com, consider www.se.com to contain the latest information.

Registered Trademarks

ARM, Cortex, and Cortex-A53 are registered trademarks of Arm Limited (or its subsidiaries).

Debian is a registered trademark of Software in the Public Interest, Inc.

QR Code is a registered trademark of DENSO WAVE INCORPORATED in Japan and other countries.

Product names used in this manual may be the registered trademarks owned by the respective proprietors.

Related Documents

You can download the manuals related to this product, such as the software manual, from the Schneider Electric download center (www.se.com/ww/en/download).

Information on Non-Inclusive or Insensitive Terminology

As a responsible, inclusive company, Schneider Electric is constantly updating its communications and products that contain non-inclusive or insensitive terminology. However, despite these efforts, our content may still contain terms that are deemed inappropriate by some customers.

Product Related Information

If the equipment is used in a manner not specified by the manufacturer, the protection provided by the equipment may be impaired.

⚡⚠ DANGER**HAZARD OF ELECTRIC SHOCK, EXPLOSION, OR ARC FLASH**

- Remove all power from the device before removing any covers or elements of the system, and prior to installing or removing any accessories, hardware, or cables.
- Unplug the power cable from both this product and the power supply prior to installing or removing the product.
- Always use a properly rated voltage sensing device to confirm power is off where and when indicated.
- Replace and secure all covers or elements of the system before applying power to this product.
- Use only the specified voltage when operating this product. This product is designed to use 9 to 36 Vdc. Always check whether your device is DC powered before applying power.

Failure to follow these instructions will result in death or serious injury.

Critical alarm indicators and system functions require independent and redundant protection hardware and/or mechanical interlocks.

When you cycle power, wait at least 10 seconds after it has been turned off. If this product is restarted too quickly, it may not operate correctly.

In the event the screen cannot be properly read, for example, if the backlight is not functioning, it may be difficult or impossible to identify a function. Functions that may present a hazard if not immediately executed, such as a fuel shut-off, must be provided independently of this product. The machine's control system design must take into account the possibility of the backlight no longer functioning and the operator being unable to control the machine or making mistakes in the control of the machine.

⚠ WARNING**LOSS OF CONTROL**

- The designer of any control scheme must consider the potential failure modes of control paths and, for certain critical control functions, provide a means to achieve a safe state during and after a path failure. Examples of critical control functions are emergency stop and overtravel stop, power outage and restart.
- Separate or redundant control paths must be provided for critical control functions.
- System control paths may include communication links. Consideration must be given to the implications of unanticipated transmission delays or failures of the link.
- Observe all accident prevention regulations and local safety guidelines.
- Each implementation of this product must be individually and thoroughly tested for proper operation before being placed into service.
- The machine control system design must take into account the possibility of the backlight no longer functioning and the operator being unable to control the machine, or making errors in the control of the machine.

Failure to follow these instructions can result in death, serious injury, or equipment damage.

For additional information, refer to NEMA ICS 1.1 (latest edition), "Safety Guidelines for the Application, Installation, and Maintenance of Solid State Control" and to NEMA ICS 7.1 (latest edition), "Safety Standards for Construction and Guide for Selection, Installation and Operation of Adjustable-Speed Drive Systems" or their equivalent governing your particular location.

NOTE: This product is a highly configurable device and is not based on a realtime operating system. Changes to the software and settings of the following must be considered new implementations as discussed in the previous warning messages. Examples of such changes include:

- Operating System
- Installed hardware
- Installed software

▲ WARNING

UNINTENDED EQUIPMENT OPERATION

- The application of this product requires expertise in the design and programming of control systems. Only persons with such expertise should be allowed to program, install, alter, and apply this product.
- Follow all applicable safety standard, local regulations and directives.

Failure to follow these instructions can result in death, serious injury, or equipment damage.

▲ WARNING

UNINTENDED EQUIPMENT OPERATION

- Do not use this product as the only means of control for critical system functions such as motor start/stop or power control.
- Do not use this equipment as the only notification device for critical alarms, such as device overheating or overcurrent.
- Use only the software provided with this product. If you use other software, please confirm the operation and safety before use.

Failure to follow these instructions can result in death, serious injury, or equipment damage.

▲ WARNING

EQUIPMENT DAMAGE

When powering off the product, use the shutdown command to properly shut down the product.

Failure to follow these instructions can result in death, serious injury, or equipment damage.

Overview

What's in This Chapter

Part Number8
 Package Contents8
 Certifications and Standards8
 Federal Communication Commission Radio Frequency Interference
 Statement - For USA9

Part Number

Series	Part name	Part number
Harmony BX1	HMIBX1A0NDA	HMIBX1A0NDA

NOTE: This product has EcoStruxure Automation Expert Soft dPAC pre-installed. The supported version is 23.0 or later. For the license activation of the software, please refer to the EcoStruxure Automation Expert documents on our website.
www.se.com

LAN port settings to connect EcoStruxure Automation Expert Soft dPAC is as follows:

LAN2
 IP address: 192.168.1.209
 Subnet mask: 255.255.255.0

Package Contents

This product has been carefully packed with special attention to quality. However, should you find anything damaged or missing, please contact your local distributor immediately.

Verify all items listed here are present in your package:

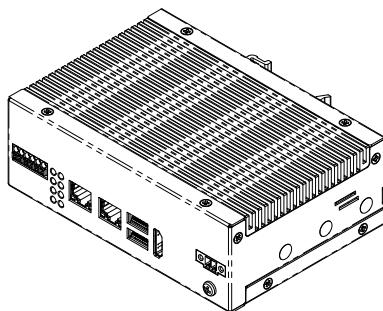

A. Harmony BX1 x 1

Certifications and Standards

The certifications and standards listed below may include those that are not yet acquired. Please check the product marking and the following URL for the latest acquisition status.
www.se.com

Agency Certifications

Underwriters Laboratories Inc., UL 61010-2-201 and CSA C22.2 N°61010-2-201, for Industrial Control Equipment used in Ordinary Locations

Compliance Standards

Europe:

CE

- Directive 2014/30/EU (EMC)
- Directive 2014/35/EU (Low Voltage)

NOTE: Harmony BX1 as a single product comply with EN 61000-6-1 and EN 55011. In order to comply with EN 61131-2, EN 61000-6-2 and EN 61000-6-4, the AC power supply adapter (ABLM1A24012) is required. Refer to *Accessories*, page 11.

UKCA

- Regulation SI 2016 No.1091
- Regulation SI 2016 No.1101

Australia:

- RCM

Hazardous Substances

This product is designed to be compliant with the following environmental regulations, even if the product may not fall directly in the scope of the regulation:

- RoHS, Directive 2011/65/EU and 2015/863/EU
- RoHS China, Standard GB/T 26572
- REACH regulation EC 1907/2006

End of Life (WEEE)

The product contains electronic boards. It must be disposed of in specific treatment channels. The product contains cells and/or storage batteries which must be collected and processed separately when they have run out and at the end of product life (Directive 2012/19/EU).

Refer to *Maintenance*, page 32 when extracting cells and batteries from the product. These batteries do not contain a weight percentage of heavy metals over the threshold notified by European Directive 2006/66/EC.

Federal Communication Commission Radio Frequency Interference Statement - For USA

FCC Radio Interference Information

This product has been tested and found to comply with the Federal Communications Commission (FCC) limits for a Class A digital device, pursuant to Part 15 of the FCC Rules. These limits are designed to provide reasonable protection against harmful interference in a commercial, industrial or business environment. This product generates, uses, and can radiate radio frequency

energy and, if not installed and used in accordance with the instructions, may cause or be subject to interference with radio communications. To minimize the possibility of electromagnetic interference in your application, observe the following two rules:

- Install and operate this product in such a manner that it does not radiate sufficient electromagnetic energy to cause interference in nearby devices.
- Install and test this product to ensure that the electromagnetic energy generated by nearby devices does not interfere with the operation of this product.

⚠ WARNING

ELECTROMAGNETIC / RADIO INTERFERENCE, UNINTENDED EQUIPMENT OPERATION

Check for electromagnetic and radio interference. If interference is detected, take the following actions.

- Increase the distance between this product and the interfering equipment.
- Reorient this product and the interfering equipment.
- Reroute power and communication lines to this product and the interfering equipment.
- Connect this product and the interfering equipment to different power supplies.
- Always use shielded cables when connecting this product to a peripheral device or another computer.

Failure to follow these instructions can result in death, serious injury, or equipment damage.

Changes or modifications not expressly approved by the party responsible for compliance could void the user's authority to operate this product.

Accessories

Products may change or be discontinued without notice. Please check our website for the latest information.

www.se.com

Product name	Product number
Power Supply	
Regulated Power Supply, 100-240 Vac, 24 V 1.2 A, single phase, Modular*1	ABLM1A24012

*1 Required to comply with IEC 61131-2, 61000-6-2 and 61000-6-4.

Parts Identification and Functions

What's in This Chapter

Parts Identification..... 12
 LED Indications (Indicators Light) 13

Parts Identification

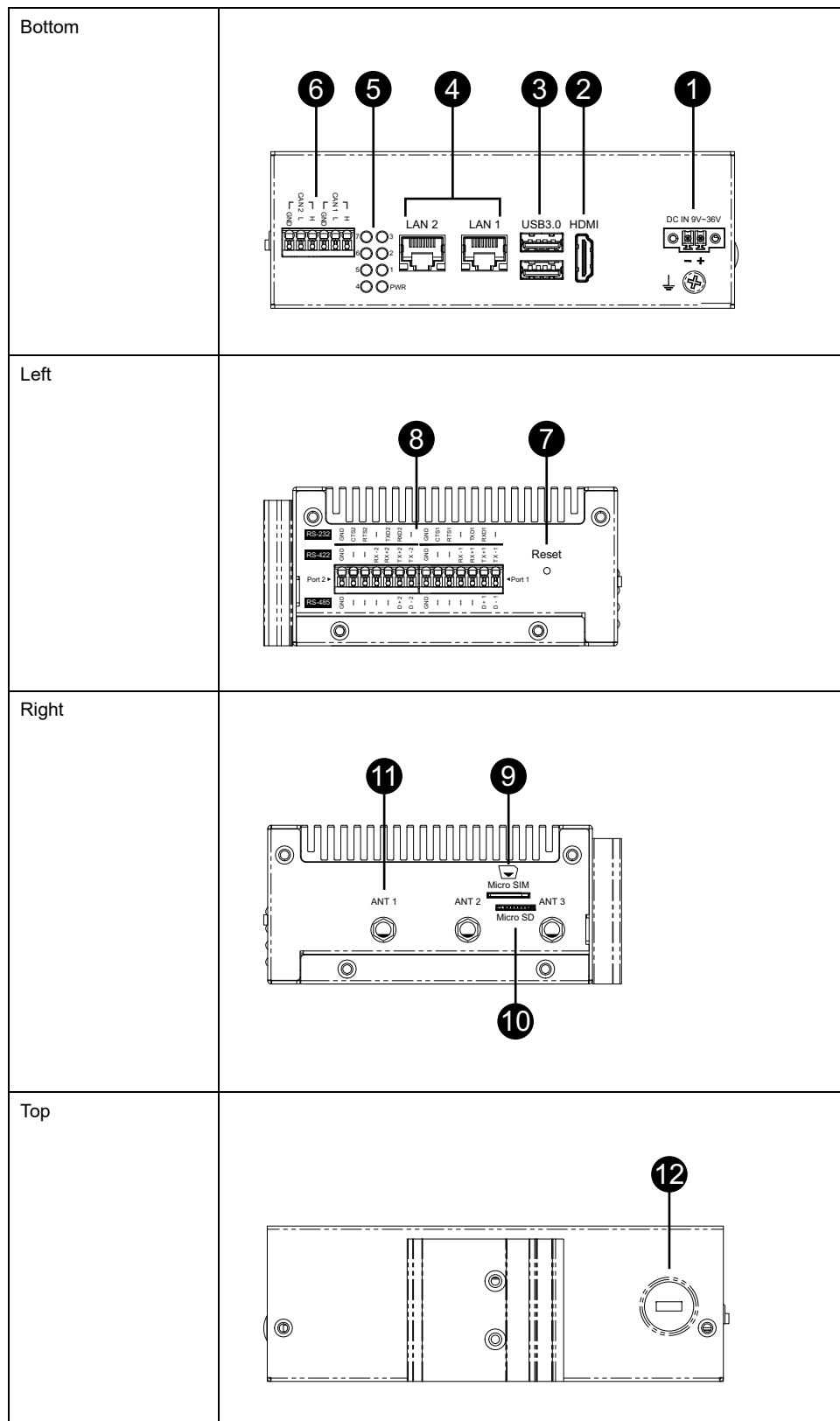

- | | |
|------------------------------|--------------------------------------|
| 1. DC power | 7. Reset button ^{*1*2} |
| 2. HDMI port | 8. RS-232/422/485 port ^{*3} |
| 3. USB 3.0 port | 9. Micro SIM slot ^{*3} |
| 4. Giga LAN port | 10. Micro SD slot |
| 5. Indicators light | 11. Antenna x 3 ^{*3} |
| 6. CAN-FD port ^{*3} | 12. Micro USB port ^{*4} |

*1 Use of reset button may lead to system reboot and may affect system operation.

*2 To reboot the product, press the button 5 times in a row with the interval of less than 0.5 seconds.

*3 Not currently supported with the pre-installed version of EcoStruxure Automation Expert Soft dPAC. For the usage of these interfaces, please contact our customer support.

*4 Not currently supported and not for general purpose usage.

<p>⚠ CAUTION</p> <p>UNINTENDED EQUIPMENT OPERATION</p> <p>Do not use the reset button until it is necessary.</p> <p>Failure to follow these instructions can result in injury or equipment damage.</p>

LED Indications (Indicators Light)

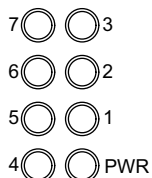

PWR	
ON	Power is on.
OFF	Power is off.

NOTE: Other LEDs than PWR are not currently supported with the pre-installed version of EcoStruxure Automation Expert Soft dPAC. For the usage of the LEDs, please contact our customer support.

Specifications

What's in This Chapter

General Specifications	14
Functional Specifications	15
Interface Specifications	16

General Specifications

Electrical Specifications

Power requirement	9 - 36 Vdc
Power consumption	24 W
MTBF (Hours)	479,374

Environmental Specifications

Physical environment	
Ambient air temperature	-10...55 °C (14...131 °F)
Storage temperature	-40...80 °C (-40...176 °F)
Ambient air and storage humidity	10...95% RH (Non condensing)
Pollution degree	For indoor use in Pollution Degree 2 environment
Mechanical environment	
Vibration resistance	IEC/EN 61131-2 compliant 5...9 Hz Single amplitude 3.5 mm (0.14 in) 9...150 Hz Fixed acceleration: 9.8 m/s ² X, Y, Z directions for 10 cycles (approximately 100 minutes)
Shock resistance	IEC/EN 61131-2 compliant 147 m/s ² , X, Y, Z directions for 3 times

Air Quality Requirements

Do not operate or store the product where chemicals evaporate, or where chemicals are present in the air:

- Corrosive chemicals: Acids, alkalines, liquids containing salt.
- Flammable chemicals: Organic solvents.

▲ CAUTION

INOPERATIVE EQUIPMENT

Do not allow water, liquids, metal, and wiring fragments to enter the panel case.

Failure to follow these instructions can result in injury or equipment damage.

Structural Specifications

Grounding	Functional grounding: Grounding resistance of 100 Ω or less, 2 mm ² (AWG 14) or thicker wire, or your country's applicable standard.
Cooling method	Natural air circulation
External dimensions (W x H x D)	140.76 x 98.2 x 48 mm (5.54 x 3.86 x 1.89 in)
Weight	0.95 kg (2.1 lb) or less

NOTICE
<p>STORAGE AND OPERATION OUTSIDE OF SPECIFICATIONS</p> <ul style="list-style-type: none"> • Store this product in areas where temperatures are within the product's specifications. • Do not restrict or block the product's ventilation slots. <p>Failure to follow these instructions can result in equipment damage.</p>

Functional Specifications

Performance Specifications

Processor	ARM® NXP i.MX8M Plus Quad-Core Cortex®-A53 1.6 GHz Processor
Memory	Onboard DDR4L 4 GB
Storage	eMMC 32 GB*1
Real time clock	RTC x 1, with 3 V CR2032 Lithium battery*2
Operating system	Debian 11

*1 The eMMC where the operating system is installed has a write lifespan. Although the eMMC is durable to handle data that is normally written in the system, continual write operations such as data logging will accelerate the end of the lifespan and lead to system failure. For continual write operations, such as data logging, write to a micro SD card or USB device.

*2 The expected battery service life is 7 years; however the battery may die before then. The battery is not user replaceable. Please contact your local distributor.

⚠ CAUTION
<p>STORAGE DEVICE DAMAGE AND DATA LOSS</p> <p>Use a Micro SD card or a USB device for continual write operation such as data logging.</p> <p>Failure to follow these instructions can result in injury or equipment damage.</p>

Interface Specifications

Specifications

NOTE: Use only the SELV (Safety Extra-Low Voltage) circuit to connect the serial, USB and Ethernet interfaces.

Serial port	RS-232/422/485 switchable x 2, Phoenix Connector
Ethernet	RJ-45 Gigabit Ethernet x 2
USB	USB 3.0 Type A x 2
CAN Bus	CAN-FD x 2 CH, Phoenix Connector
Display	HDMI x 1 (Output)
Power connector	2-Pin 3.81 mm Pitch Phoenix Connector
Micro USB	Micro USB x 1
Expansion slot	Micro SIM slot x 1 Micro SD slot x 1

Interfaces

HDMI Port

HDMI



The HDMI support port enables video output to an external display.

NOTE: Recommended HDMI cable length is no longer than 3 meters.

USB 3.0 Port

USB3.0

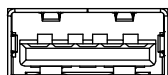

The USB 3.0 is a Type A connector, and can also support USB mass storage.

Power supply voltage	5 Vdc
Maximum current supplied	900 mA/port
Maximum transmission distance	3 m

▲ WARNING

EXPLOSION HAZARD

- Do not disconnect equipment while the circuit is live or unless the area is known to be free of ignitable concentrations.
- Remove power before attaching or detaching any connectors to or from this product.
- Ensure that power, communication, and accessory connections do not place excessive stress on the ports. Consider the vibration in the environment when making this determination.
- Securely attach power, communication, and external accessory cables to the panel or cabinet.
- Use only commercially available USB cables.

Failure to follow these instructions can result in death, serious injury, or equipment damage.

Giga LAN Port

The standard RJ-45 LAN jack is provided the connection to the Local Area Network (LAN).

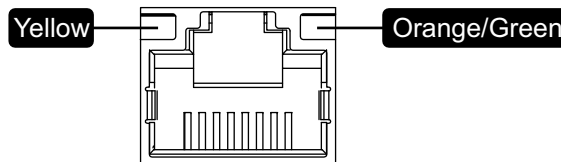

LED	Function	Status
Yellow	Active status	ON: LAN link is established. OFF: LAN link is not established. Blink: Data received and transmitted.
Orange/Green	Link Speed status	Green ON: 100 Mbps Orange ON: 1,000 Mbps

NOTE: LAN port settings to connect EcoStruxure Automation Expert Soft dPAC is as follows:

LAN2
IP address: 192.168.1.209
Subnet mask: 255.255.255.0

CAN-FD Port

Provides two phoenix CAN Bus ports for external device connection.

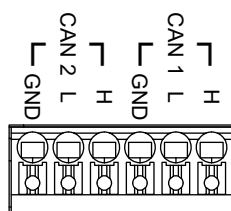

System name	Position	Pin No.	Definition
can0	CAN1	1	H
		2	L
		3	GND
can1	CAN2	1	H
		2	L
		3	GND

- CAN Bus Read/Write
- The two ports can be connected each other as below:

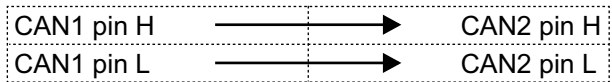

- The CAN-FD Port is connected to signals only. No external power load.
- NOTE:** This interface is not currently supported with the pre-installed version of EcoStruxure Automation Expert Soft dPAC. For the usage of the interface, please contact our customer support.

RS-232/422/485 Port

Provides two phoenix connectors for RS-232/422/485 interface.

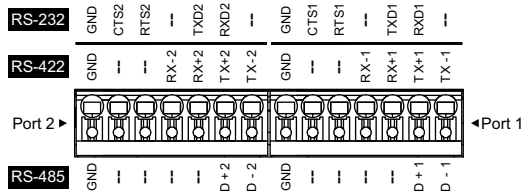

System name	Position	Pin No.	Definition		
			RS-232	RS-422	RS-485
/dev/tty xc0	COM Port 1 (P1) (CN4)	1	-	TX- 1	D- 1
		2	RXD1	TX+ 1	D+ 1
		3	TXD1	RX+ 1	-
		4	-	RX- 1	-
		5	RTS1	-	-
		6	CTS1	-	-
		7	GND	GND	GND
/dev/tty xc2	COM Port 2 (P2) (CN5)	1	-	TX- 2	D- 2
		2	RXD2	TX+ 2	D+ 2
		3	TXD2	RX+ 2	-
		4	-	RX- 2	-
		5	RTS2	-	-
		6	CTS2	-	-
		7	GND	GND	GND

NOTE:

- For serial communication, the cable length must be less than 30 meters.
- This interface is not currently supported with the pre-installed version of EcoStruxure Automation Expert Soft dPAC. For the usage of the interface, please contact our customer support.

Micro SIM Slot

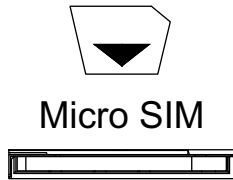

User can insert the micro SIM card into the slot when using an LTE module via the mini card slot.

NOTE: This interface is not currently supported with the pre-installed version of EcoStruxure Automation Expert Soft dPAC. For the usage of the interface, please contact our customer support.

Micro SD Slot

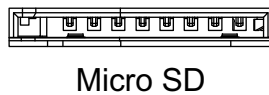

NOTE: This interface is not currently supported with the pre-installed version of EcoStruxure Automation Expert Soft dPAC. For the usage of the interface, please contact our customer support.

Antenna



The three antenna configurations are Wi-fi, 4G or LTE.

NOTE: This interface is not currently supported with the pre-installed version of EcoStruxure Automation Expert Soft dPAC. For the usage of the interface, please contact our customer support.

Mini PCIe Slot

Internal Mini PCIe cards are not currently supported with the pre-installed version of EcoStruxure Automation Expert Soft dPAC. For the usage of the interface, please contact our customer support.

Dimensions

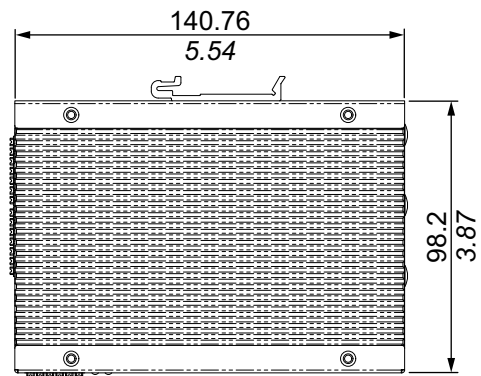

(A)

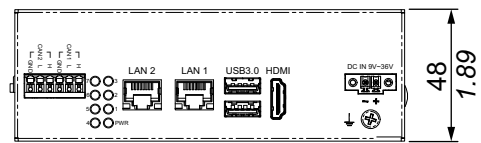

(B)

$\frac{\text{mm}}{\text{in}}$

- A. Front
- B. Bottom

Installation and Wiring

What's in This Chapter

Precautions for Building into an End-use Product.....	21
Installation Requirements.....	21
Installation of the Product.....	22
Wiring the Power Supply.....	23
Micro SD Card Installation.....	27

Precautions for Building into an End-use Product

Be aware of the following when building this product into an end-use product:

- The rear face of this product is not approved as an enclosure. When building this product into an end-use product, be sure to use an enclosure that satisfies standards as the end-use product's overall enclosure.
- Install this product in an enclosure with mechanical rigidity.
- This product is an open type device and not designed for outdoor use. UL certification obtained is for indoor use only.

Installation Requirements

⚠️ DANGER
HAZARD OF ELECTRIC SHOCK, EXPLOSION, OR ARC FLASH
<ul style="list-style-type: none">• Install this product (an open-type device) in an industrial control panel or an enclosure in the pollution degree 2 environment.• Install this product indoor only.
Failure to follow these instructions will result in death or serious injury.

⚠️ CAUTION
RISK OF BURNING INJURY
Do not touch the rear chassis during operation.
Failure to follow these instructions can result in injury or equipment damage.

- Check that the ambient air temperature and the ambient humidity are within their specified ranges in *Environmental Specifications*, page 14. When installing this product in a cabinet or enclosure, the ambient air temperature is the cabinet's or enclosure's internal and external temperature.

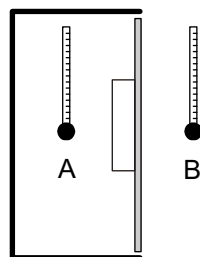

- A. Internal temperature
- B. External temperature

- Be sure that heat from surrounding equipment does not cause this product to exceed its standard operating temperature.
- For easier maintenance, operation and improved ventilation, install this product at least 100 mm (3.94 in) away from adjacent structures and other equipment as shown in the following illustration:

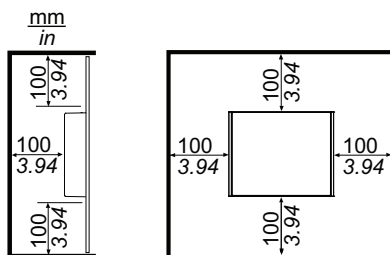

Installation of the Product

This product always requires a DIN rail to install to the panel or wall.

NOTE: Use the rail compatible with IEC 60715 TH35-7.5 for this product.

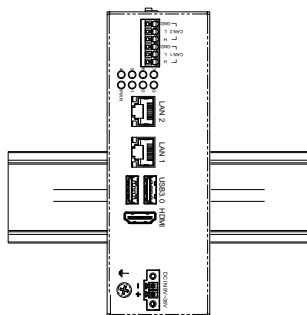

⚡⚠ DANGER

HAZARD OF ELECTRIC SHOCK, EXPLOSION, OR ARC FLASH

- Remove all power from the device before removing any covers or elements of the system, and prior to installing or removing any accessories, hardware, or cables.
- Unplug the power cable from both this product and the power supply prior to installing or removing the product.
- Always use a properly rated voltage sensing device to confirm power is off where and when indicated.
- Replace and secure all covers or elements of the system before applying power to this product.
- Use only the specified voltage when operating this product. This product is designed to use 9 to 36 Vdc. Always check whether your device is DC powered before applying power.

Failure to follow these instructions will result in death or serious injury.

⚠ CAUTION

RISK OF INJURY

Hold this product in place after removing from the DIN rail.

Failure to follow these instructions can result in injury or equipment damage.

NOTICE

EQUIPMENT DAMAGE

Keep this product stabilized while you are installing on or removing from the DIN rail

Failure to follow these instructions can result in equipment damage.

Wiring the Power Supply

DC Power Cord Preparation

DANGER

HAZARD OF ELECTRIC SHOCK, EXPLOSION, OR ARC FLASH

- Remove all power from the device before removing any covers or elements of the system, and prior to installing or removing any accessories, hardware, or cables.
- Unplug the power cable from both this product and the power supply prior to installing or removing the product.
- Always use a properly rated voltage sensing device to confirm power is off where and when indicated.
- Replace and secure all covers or elements of the system before applying power to this product.
- Use only the specified voltage when operating this product. This product is designed to use 9 to 36 Vdc. Always check whether your device is DC powered before applying power.
- Since this product is not equipped with a power switch, be sure to connect a power switch to the power supply.
- Be sure to ground this product's FG terminal.
- Use copper wire rated for 105 °C (221 °F) or higher for DC power cord.
- Tighten the wire with a torque of 0.19 N•m (1.7 lb-in) for DC power cord.
- Use the 14 to 28 AWG wire for DC power cord.

Failure to follow these instructions will result in death or serious injury.

NOTE: When the FG terminal is connected, be sure the wire is grounded. Not grounding this product can result in excessive electromagnetic interference (EMI).

- Make sure the ground wire is either the same or heavier gauge than the power wires.
- Do not use aluminum wires in the power supply's power cord.
- If the ends of the individual wires are not twisted correctly, the wires may create a short circuit. When inserting a wire into the connector, hold down the opening button and insert the wire while the internal spring is depressed. Alternatively, you can crimp and insert either a pin terminal or ferrule terminal.
- The conductor type is solid or stranded wire.
- Use the SELV (Safety Extra-Low Voltage) circuit and LIM (Limited Energy) circuit for DC input.

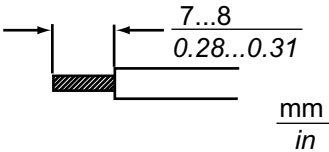
DC power cord	
Recommended cross section	0.08...2.0 mm ² (28...14 AWG)
Conductor type	Solid or stranded wire*1
Conductor length	

*1 When using stranded wires, confirm the level of current supported by the wire.

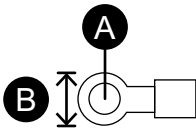
Grounding wire	
Recommended cross section	2 mm ² or more (14 AWG or greater)
Ring terminal size*1	 <p>A. $\Phi 4.3$ mm (0.17 in) or more B. 7.2 mm (0.28 in) or less</p>

*1 To prevent a short circuit caused by loose screws, use a crimp-type terminal with an insulating sleeve.

Connecting the DC Power Cord

DC Power Connector:

DC IN 9V~36V

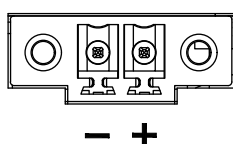

Connection	Wire
+	9...36 Vdc
-	0 Vdc

How to connect the DC Power Cord

1. Loosen the screw on the product's FG terminal, connect the grounding wire, and tighten the screw.

NOTE: The necessary torque is 0.78 N•m (6.9 lb-in).

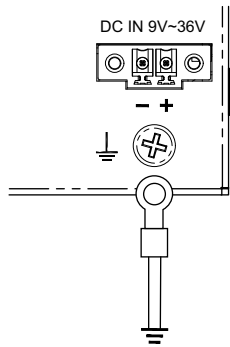

2. Confirm the power cord is not connected to the power supply.
3. Crimp a pin terminal properly to the end of each power cable wire.
4. Push the opening button with a small and flat screwdriver to open the desired pin hole.
5. Insert each power cord wire into its corresponding hole. Release the opening button to clamp the wire in place.

NOTE:

- When using stranded wire, do not short with neighboring wires.
- When connecting with stranded wires, do not solder the stranded wires.

6. After inserting the cord wires, insert the DC power connector into the power connector on this product.
7. Affix the screws on both sides of the connector.

NOTE: The necessary torque is 0.3 N•m (2.7 lb-in).

Power Supply Precautions

⚠ DANGER

SHORT CIRCUIT, FIRE, OR UNINTENDED EQUIPMENT OPERATION

- Install and fasten this product in an installation panel or cabinet prior to connecting power supply and communication lines.
- Securely attach power cables to an installation panel or cabinet.
- Avoid excessive force on the power cable.

Failure to follow these instructions will result in death or serious injury.

- This product's power cord should not be bundled with or kept close to main circuit lines (high voltage, high current), power lines, or input/output lines, and their various systems should be kept separate. When power lines cannot be wired via a separate system, use shielded cables for input/output lines.
- An independent DC power supply is recommended for this product. (The DC power supply should be located close to the product, with twisted pair cabling as short as possible.)
- To increase noise resistance, attach a ferrite core to the power cable.

Power Supply Connections

If the voltage variation is outside the prescribed range, connect a regulated power supply.

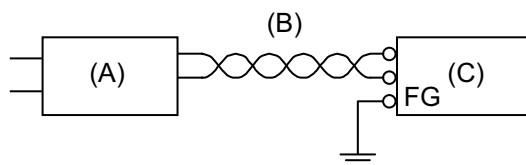

- A. Regulated power supply
- B. Twisted-pair cord
- C. This product

Grounding

Independent Grounding

Always ground the FG terminal. Be sure to separate this product from the FG of other devices as shown below.

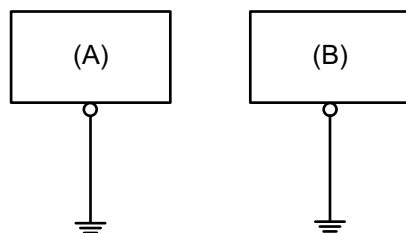

- A. This product
- B. Other equipment

Precautions

- Check that the grounding resistance is 100 Ω or less.*1
- The FG wire should have a cross sectional area 2 mm² (AWG 14) or greater*1. Create the connection point as close to this product as possible, and make the wire as short as possible. When using a long grounding wire, replace the thin wire with a thicker wire, and place it in a duct.
- The SG (signal ground) and FG (frame ground) terminals are connected internally in this product. When connecting the SG line to another device, be sure that no ground loop is formed.

*1 Observe local codes and standards.

Common Grounding

Electromagnetic Interference (EMI) can be created if devices are improperly grounded. EMI can cause loss of communication. If independent grounding is not possible, use a common grounding point as shown in the configuration below. Do not use any other configuration for common grounding.

Correct grounding

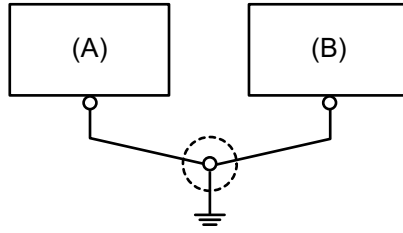

- A. This product
 - B. Other equipment
- Incorrect grounding

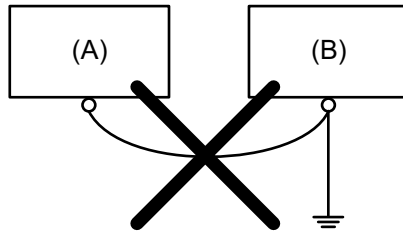

- A. This product
- B. Other equipment

Micro SD Card Installation

⚠ CAUTION

STORAGE DEVICE DAMAGE AND DATA LOSS

- Remove all power before making any contact with an installed storage device.
- Make sure you regularly back up the data since storage devices have a life span and accidental data loss can occur at any time.
- Confirm the storage device is correctly oriented before insertion.
- Do not bend, drop, or strike the storage device.
- Do not touch the storage device connectors.
- Do not disassemble or modify the storage device.
- Keep the storage device dry.

Failure to follow these instructions can result in injury or equipment damage.

To install an SD Card simply insert it into the slot on the side of the system as shown. Ensure the card is correctly oriented.



Cybersecurity

What's in This Chapter

Cybersecurity Guideline.....29

Cybersecurity Guideline

Use this product inside a secure industrial automation and control system. Total protection of components (equipment/devices), systems, organizations, and networks from cyber attack threats requires multi-layered cyber risk mitigation measures, early detection of incidents, and appropriate response and recovery plans when incidents occur. For more information about cybersecurity, refer to the Harmony HMI/iPC Cybersecurity Guide.

<https://www.se.com/ww/en/download/document/EIO0000004948/>

▲ WARNING
POTENTIAL COMPROMISE OF SYSTEM AVAILABILITY, INTEGRITY, AND CONFIDENTIALITY
<ul style="list-style-type: none">• Change default passwords at first use to help prevent unauthorized access to device settings, controls and information.• Disable unused ports/services and default accounts, where possible, to minimize pathways for malicious attacks.• Close the ports that are not going to be used.• Disable or remove server services that are not going to be utilized.• Place networked devices behind multiple layers of cyber defenses (such as firewalls, network segmentation, and network intrusion detection and protection).• Set sticky bit on all world-writable directories.• Restrict core dumps.• Ensure the syslog service is running.• Apply the latest updates and hotfixes to your Operating System and software.• Use cybersecurity best practices (for example: least privilege, separation of duties) to help prevent unauthorized exposure, loss, modification of data and logs, interruption of services, or unintended operation.
Failure to follow these instructions can result in death, serious injury, or equipment damage.

NOTE: For more details and assistance on how to apply the latest updates and hotfixes, please contact our customer support.

First System Login

What's in This Chapter

Login and Password Change	30
---------------------------------	----

Login and Password Change

When changing the system settings in order to reduce the risks of unauthorized access, intrusion and infection of malicious software, connect a monitor and keyboard to log into the system. After the first login, change the default password.

User name: eadmin

Default password: EE@dmin1

When changing the password, follow the following password policy:

- Passwords should have at least 12 characters.
- Passwords should not contain the username.
- Passwords should include the four available character types: lowercase letters, uppercase letters, numbers, and symbols. Symbols must include any one of [!"#\$%&'()*+,-./:;<=>?@^_`{|}~].

NOTE: It is not possible to retrieve a user name and a password that has been lost.

NOTICE

ACCESS LOSS

Store your devices's user and password information in a secure location.

Failure to follow these instructions can result in equipment damage.

System Recovery

What's in This Chapter

System Recovery Tool	31
----------------------------	----

System Recovery Tool

If you need a system recovery file and a recovery media creation tool in case of system failure or to update the operating system, contact our customer support.

Maintenance

What's in This Chapter

Regular Cleaning	32
Periodic Check Points.....	32
Replacing the Battery	33

Regular Cleaning

Cleaning This Product

NOTICE

EQUIPMENT DAMAGE

- Power off this product before cleaning it.
- Do not use paint thinner, organic solvents, or a strong acid compound to clean the unit.

Failure to follow these instructions can result in equipment damage.

When this product gets dirty, wipe with a soft, dry cloth or a soft cloth soaked in only water and wrung tightly.

Periodic Check Points

Operation Environment

- Is the ambient air temperature within the allowable range? Refer to Environmental Specifications, page 14.
- Is the ambient air humidity within the specified range? Refer to Environmental Specifications, page 14.

When this product is inside a panel or cabinet, the ambient environment refers to the interior of the panel or cabinet.

Electrical Specifications

- Is the input voltage appropriate? Refer to Electrical Specifications, page 14.
- Are all power cords and cables connected properly? Are there any loose cables?
- Are all installation fasteners holding the unit securely?
- Are there scratches or traces of dirt on the installation gasket?

Unit Disposal

When disposing this product, dispose it in a manner appropriate to, and in accordance with, your country's industrial machinery disposal/recycling standards.

Replacing the Battery

⚠ ⚠ DANGER

HAZARD OF ELECTRIC SHOCK, EXPLOSION, OR ARC FLASH

Do not replace the battery. Contact your local distributor when replacement is required.

Failure to follow these instructions will result in death or serious injury.

Schneider Electric
35 rue Joseph Monier
92500 Rueil Malmaison
France

+ 33 (0) 1 41 29 70 00

www.se.com

As standards, specifications, and design change from time to time,
please ask for confirmation of the information given in this publication.

© 2023 – Schneider Electric. All rights reserved.

EIO0000005096_03