

TOFU

Apparecchio LED biemissione per installazione a parete. Corpo in alluminio estruso, spessore di soli 50mm, e schermi in policarbonato opale. Disponibile in due finiture - bianco e grigio - e due temperature colore: 3000K e 4000K.

LED luminaire for direct/indirect light emission for wall installation. Extruded aluminium body, only 50mm thin and opal polycarbonate diffusers. Available in two finishes - white and grey - and two gradiations: 3000K and 4000K.



Codice Code	CCT	Flusso lm Flux lm	Potenza Wattage	Dimensioni mm Dimensions mm
TOF019XX	3000K	5606	38W	540 x 50 x 158
TOF020XX	4000K	5844	38W	540 x 50 x 158

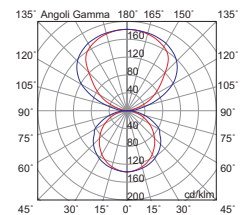

Finiture Finishes



B

GR

Accessori Accessories



versione **DALI** per tutti i codici
DALI version for all codes

Esempio Example
cod. **TOF019BDA**

Altre applicazioni Other applications



Sistemi lineari
Linear System



p.365



Sistema lineare LED monoemissione e biemissione per installazione a soffitto o a sospensione.

Corpo in alluminio estruso, spessore di soli 50mm, e schermo in policarbonato opale - da ordinare come accessorio.

Possibilità di configurazione in linea - max. 1500W - tramite giunti lineari e angolari.

Disponibile in due finiture, bianco e grigio, e due temperature colore, 3000K e 4000K.

LED lineare luminaire for direct or direct/indirect light emission for ceiling or suspension installation.

Extruded aluminium body, only 50mm thin and opal polycarbonate diffuser - to be ordered as an accessory.

In-line configuration - max. 1500W - with linear and angular joints.

Available in two finishes, white and grey, and two gradations, 3000K and 4000K.

TOFU

MONOEMISSIONE LUCE DIRETTA DIRECT LIGHT



Codice Code	CCT	Flusso lm Flux lm	Potenza Wattage	Dimensioni mm Dimensions mm
TOF001XX	3000K	5595	40W	1080 x 158 x 50
TOF002XX	4000K	5860	40W	1080 x 158 x 50
TOF003XX	3000K	8392	60W	1620 x 158 x 50
TOF004XX	4000K	8790	60W	1620 x 158 x 50

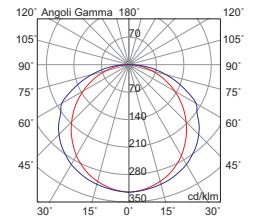
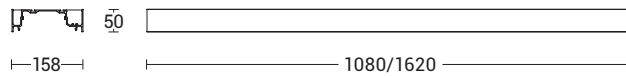

Testate di chiusura, schermo, kit fissaggio, rosone e giunti da ordinare separatamente.

End caps, diffuser, fixing kit, ceiling rose and joints to be ordered separately.

BIEMISSIONE DIRECT-INDIRECT LIGHT



Codice Code	CCT	Flusso lm Flux lm	Potenza Wattage	Dimensioni mm Dimensions mm
TOF005XX	3000K	5595+5117	40W+36W	1080 x 158 x 50
TOF006XX	4000K	5860+5361	40W+36W	1080 x 158 x 50
TOF007XX	3000K	8392+7675	60W+54W	1620 x 158 x 50
TOF008XX	4000K	8790+8041	60W+54W	1620 x 158 x 50

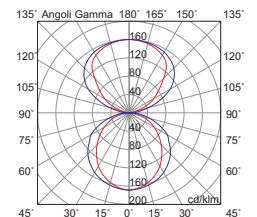
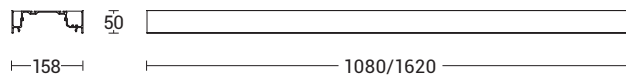

Testate di chiusura, schermo, kit fissaggio, rosone e giunti da ordinare separatamente.

End caps, diffuser, fixing kit, ceiling rose and joints to be ordered separately.

Finiture Finishes



B

GR

Accessori Accessories



versione **DALI** per tutti i codici
DALI version for all codes

Esempio Example
cod. **TOF005BDA**

Altre applicazioni Other applications



Parete Wall - p.241

ACCESSORI ACCESSORIES

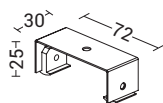
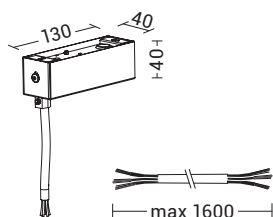
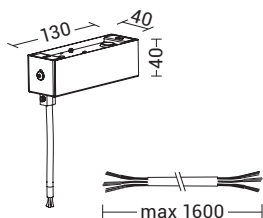
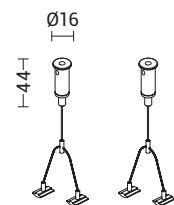
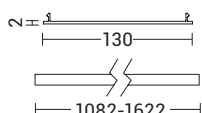
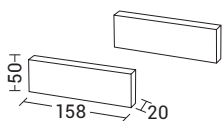

Codice

Code

TOF101XX

Kit con coppia di testate terminali in pressofusione di alluminio, verniciate. Fissaggio con viti. Da usare su moduli singoli o sugli ultimi della linea.

End caps kit with pair of powder coated die-cast aluminium end caps. Fixed with screws. To be used on single modules or on the last modules of the line.

Codice

Code

TOF103 1082mm - 40W

TOF104 1622mm - 60W

Schermo diffusore in policarbonato opale, per la diffusione della luce. Fissaggio a scatto. Permette di ottenere il grado di protezione IP40.

Opal polycarbonate diffuser, snap on fixture. Allows IP40 protection degree of the fitting.

Codice

Code

TOF108

Kit sospensione: coppia di nottolini in ottone cromato, con funi in acciaio 1500mm. Dispositivo per regolazione millimetrica. Carico massimo 7 kg per fune.

Suspension Kit: pair of chromed brass ceiling roses, with wire ropes 1500mm. Device for millimetric regulation. Maximum load 7 kg per rope.

Codice

Code

YEN121XX

Rosone elettrificato per sospensione ON-OFF, quadrato in lamiera verniciata con morsetto e cavo di alimentazione trasparente (3x1,5mm²), lunghezza max 1600mm.

Electrified ceiling rose for ON-OFF suspension, square powder coated sheet steel ceiling rose with clip and transparent power cable (3x1,5mm²), max length 1600mm.

Codice

Code

YEN122XX

Rosone elettrificato per sospensione DALI, quadrato in lamiera verniciata con morsetto e cavo di alimentazione trasparente (5x1,5mm²), lunghezza max 1600mm.

Electrified ceiling rose for DALI suspension, square powder coated sheet steel ceiling rose with clip and transparent power cable (5x1,5mm²), max length 1600mm.

Codice

Code

TOF109XX

Kit attacco a soffitto in lamiera verniciata e staffe in poliammide. Fissaggio con viti. Permette di fissare i moduli direttamente a soffitto.

Ceiling connection Kit. Powder coated steel sheet and polyamide brackets. Fixed with screws. Makes it possible to fix the modules straight onto the ceiling.

TOFU

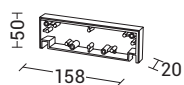

Codice
Code

TOF105XX

Giunto lineare in pressofusione di alluminio, verniciato. Fissaggio con viti. Permette di realizzare una giunzione in linea tra due moduli.

Linear joint. Powder coated die-cast aluminium joint. Fixed with screws. Used to make a straight joint between two modules.

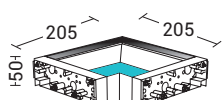

Codice
Code

TOF106XX

Giunto angolare a "L" cieco destro in profilo e pressofusione di alluminio, verniciato. Permette di realizzare una giunzione a 90° verso destra tra due moduli.

Right blind angle joint "L". Powder coated aluminium profile and die-cast aluminium joint. Used to make a right 90° joint between two modules.

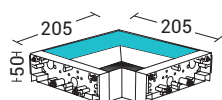

Codice
Code

TOF107XX

Giunto angolare a "L" cieco sinistro in profilo e pressofusione di alluminio, verniciato. Permette di realizzare una giunzione a 90° verso sinistra tra due moduli.

Left blind angle joint "L". Powder coated aluminium profile and die-cast aluminium joint. Used to make a left 90° joint between two modules.

ESEMPIO DI COMPOSIZIONE CON GIUNTI ANGOLARI COMPOSITION EXAMPLE WITH ANGLE JOINT

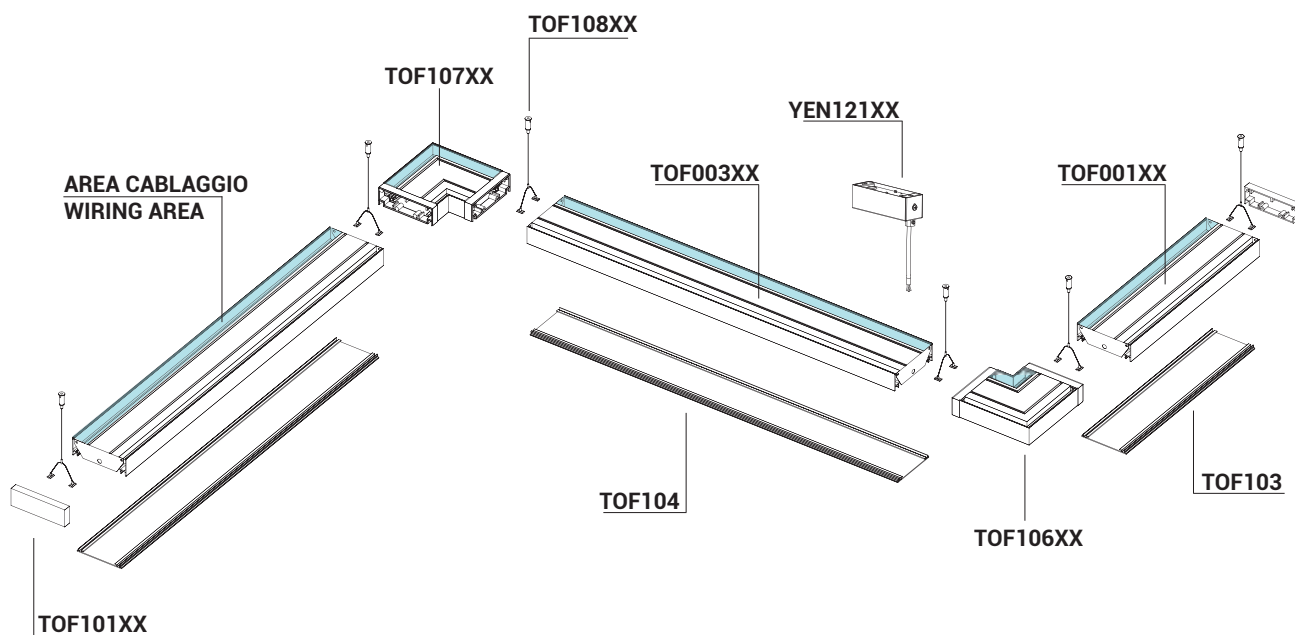

Finiture Finishes



B

GR