

INCASSO SOTTILE  
RECESSED THIN

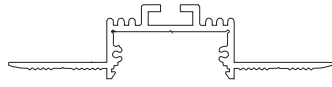

IN CASSO RASATO  
RECESSED FRAMELESS

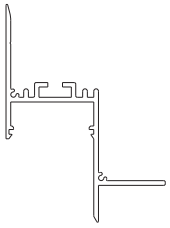

RASATO LATERALE  
SIDE FRAMELESS

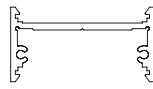

PARETE/PLAFONE  
WALL/CEILING

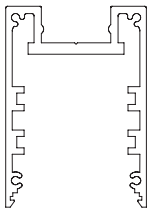

PLAFONE/SOSPENSIONE  
CEILING/SUSPENSION

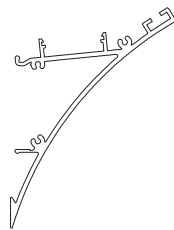

PARETE  
WALL

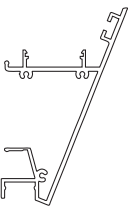

PARETE  
WALL



PARETE  
WALL

Profilo in alluminio estruso per alloggiare strip LED, fornito in lunghezza 2000mm, sezionabile.

Disponibile in due differenti profondità e tre finiture, bianco, grigio e nero.

Prodotto estremamente versatile per le diverse applicazioni da completare con i vari kit di installazione: ad incasso con cornice e rasato, a parete/plafone, a sospensione e per installazioni perimetrali. Le dimensioni in larghezza del profilo permettono l'installazione di più strip LED.

Vi sono inoltre due diversi alloggiamenti in cui è possibile posizionare il dissipatore su cui viene applicata la strip, per una maggiore o minore emissione luminosa.

Da completare con diffusore in policarbonato opale microprismato o nero, in versione bassa (a filo) o alta (con spessore ed emissione laterale).

Linear profile in extruded aluminium, for placing LED strip, 2000mm long body, cut to size.

Available in two depths and three finishes, white, grey and black.

Extremely versatile product, for various installations to be completed with related fixing KIT: recessed (both with frame and frameless), wall/ceiling, suspended version and for perimeter installation. The widths of the profile allows to place different LED strips.

There are even two slots for fixing the aluminium heatsinker profile where LED strip is then positioned, allowing more or less light emission.

To be completed with opal polycarbonate or microprismatic diffuser to be ordered separately, in low or high version (for side light emission).

# EBI



**INCASSO SOTTILE**  
**RECESSED THIN**

Codice  
Code

**EBI007B**

2000 x 43 x 18 mm

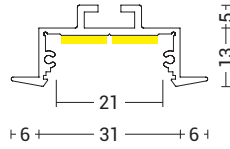

▽ foro hole L.37 x P.20 mm

servizio service **TAILOR MADE**

esempio example

cod. **EBI007BCM + EBI005CM**



diffusore opale  
opal diffuser



diffusore microprismato  
microprismatic diffuser

alloggiamento fino a 2 strip LED  
you can install up to 2 strip LEDs

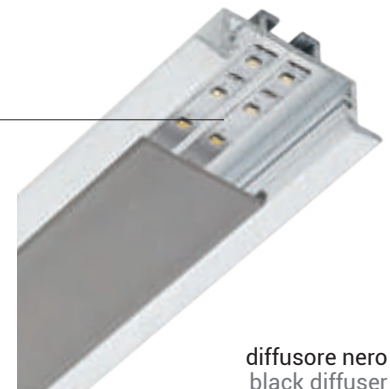

diffusore nero  
black diffuser

**Finiture Finishes**

**Bianco** White

**Accessori Accessories**

strip LED (max **36W/mt**)  
p.422

driver  
p.432

controller  
p.434

## ACCESSORI ACCESSORIES

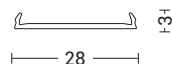

Codice  
Code

**EBI005** opale opal

**EBI005MP** microprismato microprismatic

**EBI005N** nero black

Diffusore in policarbonato opale, microprismato o nero basso (a filo), 2mt.  
Opal, microprismatic or black polycarbonate diffuser, flat version, 2mt.

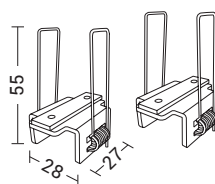

Codice  
Code

**EBI009MT**

Molle di fissaggio in alluminio for cartongesso (2pz).  
Aluminium fixing springs for plasterboard installation (2pz).

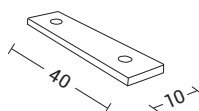

Codice  
Code

**EBI030**

Giunto lineare in alluminio comprensivo di 2 grani 4x6 mm.  
Aluminium linear joint with 2 grub screws 4x6mm.

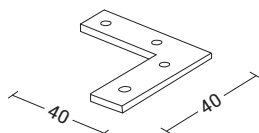

Codice  
Code

**EBI062**

Giunto angolare in alluminio comprensivo di 4 grani 40x40 mm per EBI007B.  
Angular joint in aluminum including 4 grub screws 40x40 mm for EBI007B.

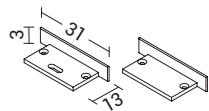

Codice  
Code

**EBI008B**

Tappo di chiusura (2pz) in alluminio bianco.  
White aluminium end caps (2pcs).

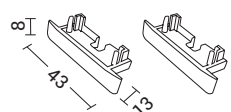

Codice  
Code

**EBI020B**

Tappi di chiusura in plastica bianca (2pz).  
White plastic end caps (2pcs).

**INCASSO RASATO**  
**RECESSED FRAMELESS**

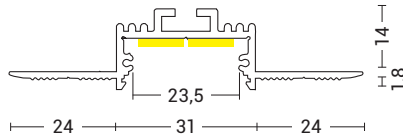

Codice  
Code

**EBI021XX**  
2000 x 79 x 15,8 mm

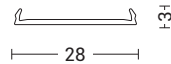

▽ foro hole L.31 x P.20 mm

servizio service **TAILOR MADE**  
 esempio example  
 cod. **EBI021BCM + EBI005CM**

**ACCESSORI**  
**ACCESSORIES**

Codice  
Code

**EBI005** opale opal  
**EBI005MP** microprismato microprismatic  
**EBI005N** nero black

Diffusore in policarbonato opale, microprismato o nero basso (a filo), 2mt.  
 Opal, microprismatic or black polycarbonate diffuser, flat version, 2mt.

Codice  
Code

**EBI030**  
 Giunto lineare in alluminio comprensivo di 2 grani 4x6 mm.  
 Aluminium linear joint with 2 grub screws 4x6mm.

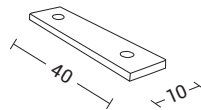

Codice  
Code

**EBI062**  
 Giunto angolare in alluminio comprensivo di 4 grani 40x40 mm per EBI007B.  
 Angular joint in aluminum including 4 grub screws 40x40 mm for EBI007B.

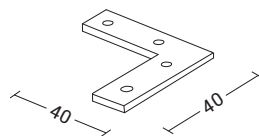

alloggiamento fino a 2 strip LED  
 you can install up to 2 strip LEDs



Finiture Finishes



**B**

**GR**

Accessori Accessories

strip LED (max **36W/mt**)  
p.422

driver  
p.432

controller  
p.434

## RASATO LATERALE SIDE RECESSED FRAMELESS

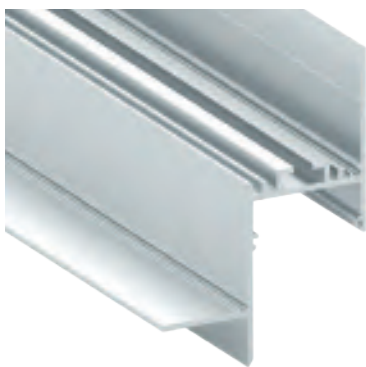

Codice  
Code

**EBI060B**

2000 x 54 x 74 mm

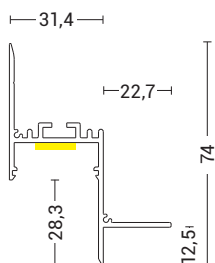

foro hole L.31,4 x P.74 mm

servizio service **TAILOR MADE**

esempio example

cod. **EBI060BCM + EBI005MPCM**

## ACCESSORI ACCESSORIES

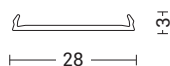

Codice  
Code

**EBI005** opale opal

**EBI005MP** microprismato microprismatic

**EBI005N** nero black

Diffusore in policarbonato opale, microprismato o nero basso (a filo), 2mt.  
Opal, microprismatic or black polycarbonate diffuser, flat version, 2mt.

Codice  
Code

**EBI030**

Giunto lineare in alluminio comprensivo di 2 grani 4x6 mm.  
Aluminium linear joint with 2 grub screws 4x6mm.

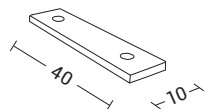

Codice  
Code

**EBI062**

Giunto angolare in alluminio comprensivo di 4 grani 40x40 mm per EBI007B.  
Angular joint in aluminum including 4 grub screws 40x40 mm for EBI007B.

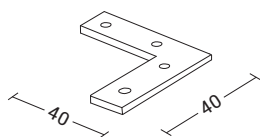

Codice  
Code

**EBI061B**

Kit tappi di chiusura in alluminio (2pz).  
Aluminium end caps (2pcs).

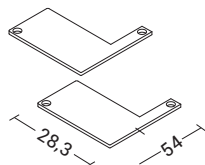

Finiture Finishes



Bianco White

Accessori Accessories

strip LED (max **36W/mt**)  
p.422

driver  
p.432

controller  
p.434

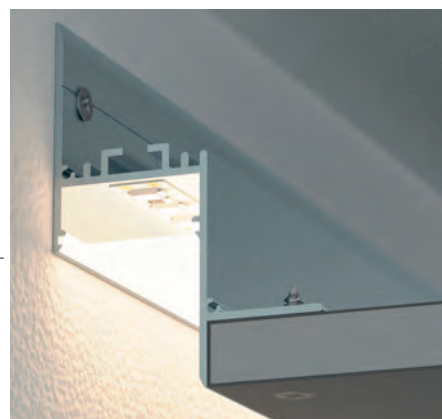

PARETE/PLAFONE  
WALL/CEILING



Codice  
Code

**EBI001XX**

2000 x 31 x 16 mm

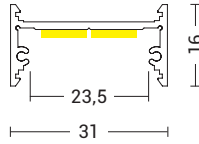

servizio service **TAILOR MADE**  
esempio example  
cod. **EBI001GRCM + EBI005CM**



diffusore basso  
flat diffuser



diffusore opale  
opal diffuser



diffusore alto  
wide diffuser



diffusore microprismato  
microprismatic diffuser



diffusore nero  
black diffuser

Finiture Finishes



**B**

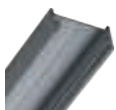

**GR**



**N**

Accessori Accessories

strip LED (max **36W/mt**)  
p.422

driver  
p.432

controller  
p.434

## ACCESSORI ACCESSORIES

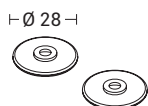
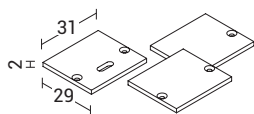
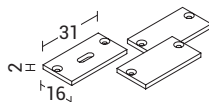
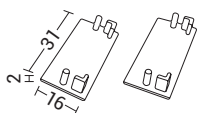
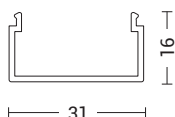
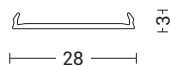

Codice  
Code

**EBI005** opale opal  
**EBI005MP** microprismato microprismatic  
**EBI005N** nero black

Diffusore in policarbonato opale, microprismato o nero basso (a filo), 2mt.  
Opal, microprismatic or black polycarbonate diffuser, flat version, 2mt.

Codice  
Code

**EBI006** opale opal

Diffusore in policarbonato opale alto (con spessore ed emissione laterale di luce), 2mt.  
Opal polycarbonate diffuser, wide version (for side light emission), 2mt.

Codice  
Code

**EBI019XX**

Tappi di chiusura in plastica (2pz) per diffusore basso.  
Aluminium end caps (3pcs) for flat diffuser.

Codice  
Code

**EBI002XX**

Tappi di chiusura (3pz) in alluminio per diffusore basso.  
Aluminium end caps (3pcs) for flat diffuser.

Codice  
Code

**EBI003XX**

Tappi di chiusura (3pz) in alluminio per diffusore alto.  
Aluminium end caps (3pcs) for up diffuser.

Codice  
Code

**EBI004MT**

Attacco a parete/plafone in ottone (2pz).  
Brass wall and ceiling kit (2pcs).

### Finiture Finishes



B



GR



N

PLAFONE/SOSPENSIONE  
CEILING/SUSPENSION



Codice  
Code

**EBI012XX**

2000 x 31 x 44 mm

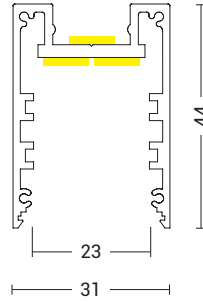

servizio service **TAILOR MADE**

esempio example

cod. **EBI012GRCM + EBI005MPCM**



diffusore basso  
flat diffuser

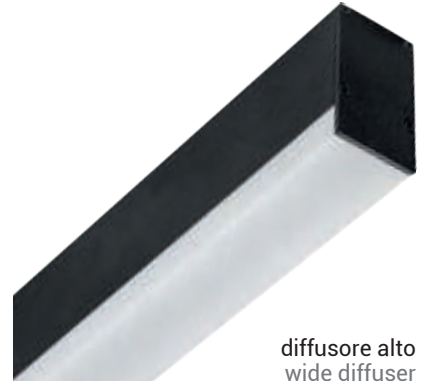

diffusore alto  
wide diffuser



Dissipatore posizionabile a diverse altezze per una maggiore o minore emissione luminosa.



Aluminium heatsink profile to be fixed in two slots allowing more or less light emission.

Finiture Finishes



**B**



**GR**

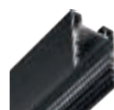

**N**

Accessori Accessories

strip LED - max 30W/mt totale  
luce diretta e indiretta  
strip LED - max 30W/mt total  
direct and direct-indirect light

p.422

driver  
p.432

controller  
p.434

## ACCESSORI ACCESSORIES

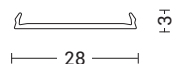

Codice  
Code

**EBI005** opale opal  
**EBI005MP** microprismato microprismatic  
**EBI005N** nero black

Diffusore in policarbonato opale, microprismato o nero basso (a filo), 2mt.  
Opal, microprismatic or black polycarbonate diffuser, flat version, 2mt.

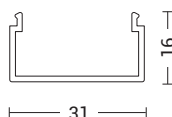

Codice  
Code

**EBI006** opale opal

Diffusore in policarbonato opale alto (con spessore ed emissione laterale di luce), 2mt.  
Opal polycarbonate diffuser, wide version (for side light emission), 2mt.

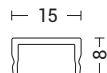

Codice  
Code

**WAS008TR** trasparente transparent

**WAS008OP** opale opal

**WAS008N** nero black

Diffusore superiore in policarbonato opale, trasparente o nero, per sospensione biemissione. 2mt.  
Polycarbonate upper diffuser, in opal, transparent or black finish, for direct-indirect light emission. 2mt.

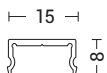

Codice  
Code

**WAS003XX**

Modulo cieco superiore in alluminio, in tinta, per sospensione monoemissione (luce diretta). 2mt.  
Blank module, in painted aluminium, for direct light suspended version. 2mt.

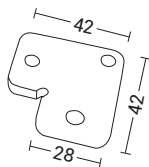

Codice  
Code

**EBI018**

Giunto angolare in alluminio grigio con fori filettati e due ganci in acciaio inox per tenere uniti due profili e creare un angolo di 90°.  
Grey aluminium linear joint with threaded holes and stainless steel hooks, necessary to hold two profiles creating a 90° angle.

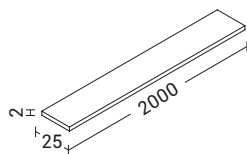

Codice  
Code

**EBI016**

Profilo dissipatore in alluminio, su cui applicare la strip LED. 2mt.  
Aluminium heatsink profile, where strip LED needs to be positioned. 2mt.

### Finiture Finishes



B



GR



N

### Accessori Accessories

strip LED - max 30W/mt totale  
luce diretta e indiretta  
strip LED - max 30W/mt total  
direct and direct-indirect light

p.422

driver  
p.432

controller  
p.434

## ACCESSORI ACCESSORIES

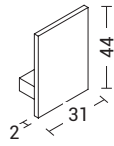

Codice  
Code

### EBI013XX

Tappo di chiusura (1pz) in alluminio, in tinta, per diffusore basso.  
Painted aluminium end caps (1pcs) for flat diffuser.

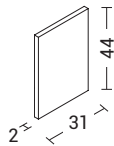

Codice  
Code

### EBI025XX

Tappo di chiusura (2pz) in plastica per diffusore basso.  
Plastic end caps (1pcs) for flat diffuser.

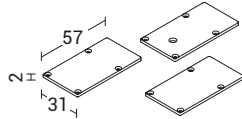

Codice  
Code

### EBI014XX

Tappi di chiusura (3pz) in alluminio per diffusore alto.  
Aluminium end caps (3pcs) for wide diffuser.

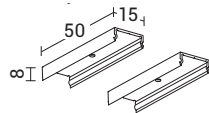

Codice  
Code

### WAS002XX

Attacchi a plafone o supporti per il cavo di tenuta, nella versione sospensione. 2 pezzi.  
Ceiling kit or modules where the suspension ropes need to be attached on the suspended version. 2 pieces.

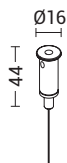

Codice  
Code

### WAS001MT

Fune in acciaio (2000mm, carico massimo 7Kg) e nottolino in ottone cromato con dispositivo per regolazione millimetrica.  
Wire rope (2000mm, max load 7Kg) and chromed brass ceiling rose with device for millimetric regulation.

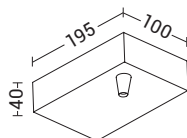

Codice  
Code

### EBI017XX

Rosone in alluminio, per alloggiare l'alimentatore LED nella versione a sospensione (controllare misure del driver per l'alloggiamento).  
Aluminium ceiling rose, where the LED driver can be housed for the suspended version (check the driver sizes for the housing).

#### Finiture Finishes



B



GR



N

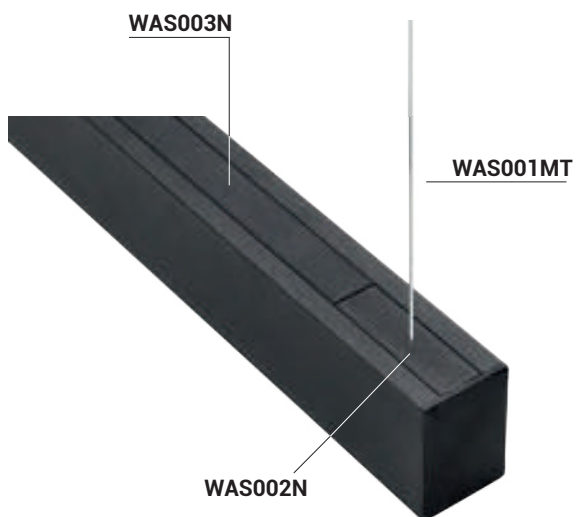

modulo cieco per sospensione monoemissione  
blank module for direct light

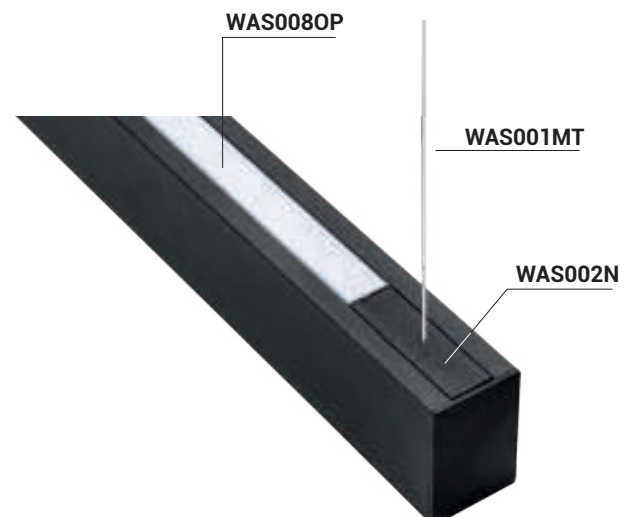

schermo superiore per sospensione biemissione  
upper diffuser for direct and indirect light

**PARETE MONOEMISSIONE - LUCE INDIRECTA**  
**WALL INDIRECT LIGHT**

diffusore non incluso  
 diffusers not included



Codice  
 Code

**EBI027B**  
 2000x76x101,4 mm

alloggiamento fino a 2 strip LED  
 you can install up to 2 strip LEDs

profilo per fissaggio a muro  
 profile for wall mounting

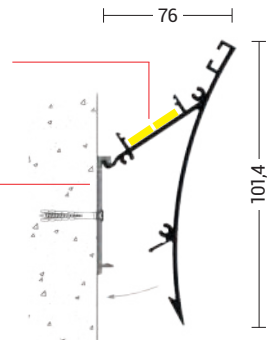

servizio service **TAILOR MADE**

esempio example  
 cod. **EBI027BCM + EBI005CM + EBI029CM**



**PARETE BIEMISSIONE**  
**WALL DIRECT-INDIRECT LIGHT**

diffusori non inclusi  
 diffusers not included

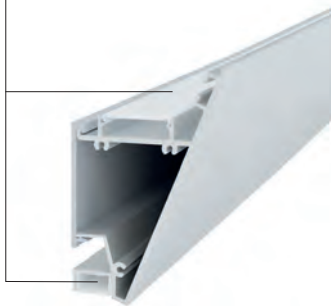

Codice  
 Code

**EBI031B**  
 2000x62,7x95,5 mm

alloggiamento fino a 2 strip LED  
 you can install up to 2 strip LEDs

profilo per fissaggio a muro  
 profile for wall mounting

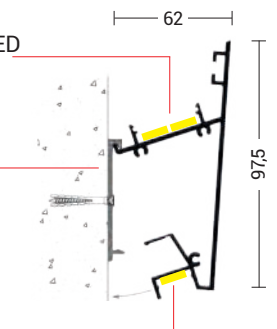

servizio service **TAILOR MADE**

esempio example  
 cod. **EBI031BCM + EBI005CM + EBI029CM**



**PARETE BIEMISSIONE**  
**WALL DIRECT-INDIRECT LIGHT**

diffusori non inclusi  
 diffusers not included

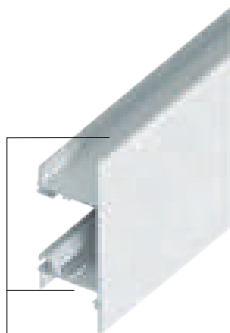

Codice  
 Code

**EBI050B**  
 2000x35,7x110 mm

alloggiamento di 1 strip LED  
 you can install 1 strip LEDs

profilo per fissaggio a muro  
 profile for wall mounting

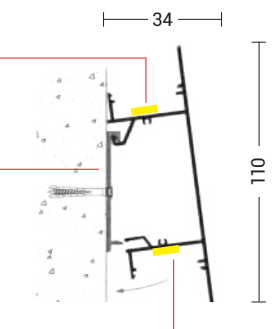

servizio service **TAILOR MADE**

esempio example  
 cod. **EBI050BCM + EBI005CM + EBI029CM**



alloggiamento di 1 strip LED  
 you can install 1 strip LEDs

**Finiture Finishes**



**Bianco White**

**Accessori Accessories**

**EBI027B**  
 strip LED  
 max 36W/mt

p.422

**EBI031B**  
 strip LED  
 max 50W/mt tot.  
 dir.+ indir.

p.422

**EBI050B**  
 strip LED  
 max 30W/mt tot.  
 dir.+ indir.

p.422

driver  
 p.432

controller  
 p.434

## ACCESSORI ACCESSORIES

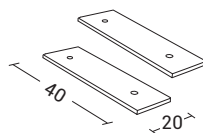
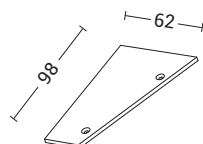
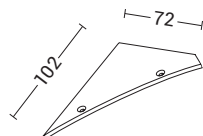
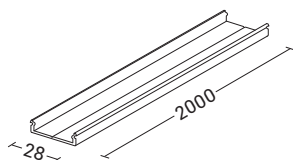
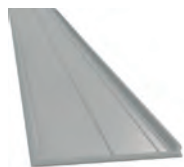
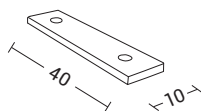
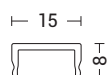
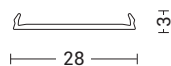

Codice  
Code

**EBI005** opale opal  
**EBI005MP** microprismato microprismatic  
**EBI005N** nero black

Diffusore in policarbonato opale, microprismato o nero basso (a filo), 2mt.  
Opal, microprismatic or black polycarbonate diffuser, flat version, 2mt.

Codice **Solo per EBI031B**  
Code **Only for EBI031B**

**WAS008TR** trasparente transparent  
**WAS008OP** opale opal  
**WAS008N** nero black

Diffusore superiore in policarbonato opale, trasparente o nero, per  
sospensione biemissione. 2mt.  
Polycarbonate upper diffuser, in opal, transparent or black finish,  
for direct-indirect light emission. 2mt.

Codice **Solo per EBI027B - EBI031B**  
Code **Only for EBI027B - EBI031B**

**EBI030**

Giunto lineare in alluminio comprensivo di 2 grani 4x6 mm.  
Aluminium linear joint with 2 grub screws 4x6mm.

Codice  
Code

**EBI029**

Profilo in alluminio grezzo per fissaggio a muro, 2mt.  
Rough aluminium profile for wall mounting, 2mt.

Codice **Solo per EBI027B**  
Code **Only for EBI027B**

**EBI028B**

Tappo di chiusura bianco (2pz) in alluminio verniciato bianco, più  
4 viti autofilettanti in acciaio inox.  
White aluminium end caps (2 pcs.) white painted plus 4 stainless  
steel self tapping screws.

Codice **Solo per EBI031B**  
Code **Only for EBI031B**

**EBI032B**

Tappo di chiusura bianco (2pz) in alluminio verniciato bianco, più  
4 viti autofilettanti in acciaio inox.  
White aluminium end caps (2 pcs.) white painted plus 4 stainless  
steel self tapping screws.

Codice **Solo per EBI050B**  
Code **Only for EBI050B**

**EBI051B**

Tappo di chiusura bianco (2pz) in alluminio verniciato bianco, più  
4 viti autofilettanti in acciaio inox.  
White aluminium end caps (2 pcs.) white painted plus 4 stainless  
steel self tapping screws.