



YEN





YEN MONO
alimentatore a bordo
on board driver
p.297

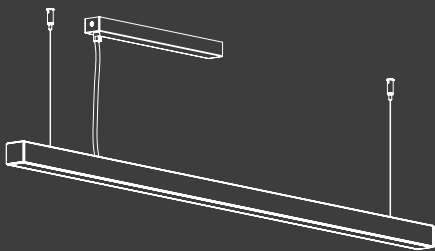

YEN MONO
alimentatore remoto
remote driver
p.297

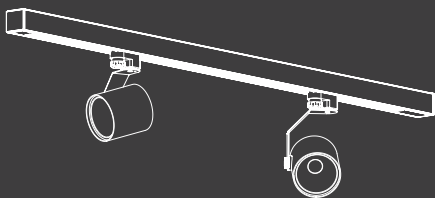

YEN MONO BINARIO TRIFASE
THREE-PHASE TRACK YEN MONO
p.298



YEN DOPPIO BIEMISSIONE
DIRECT-INDIRECT YEN DOPPIO
p.299

Sistema lineare LED monoemissione o biemissione, con alimentatore in remoto o a bordo, per installazione a soffitto (con kit attacco a plafone), a sospensione (con kit sospensione e rosone) o a sistema in fila continua (con giunto lineare e angolare, fino a max 1500W).

Altamente versatile grazie alle molteplici combinazioni possibili date dai differenti moduli, il binario trifase, l'ottica opale o antiriflesso per UGR<19 che lo rendono particolarmente adatto ad installazione in ambienti con videoterminali.

Struttura in alluminio estruso dalla forma squadrata ed essenziale, disponibile in versione mono o doppia, verniciata con polveri epossidiche in tre finiture (bianco, nero e grigio).

Disponibile in diverse misure e relative potenze, in due temperature colore (3000K e 4000K) e, in alcuni versioni, con sistema DALI su richiesta. Apparecchio da completare con kit testate terminali, schermi e accessori da ordinare separatamente.

LED linear luminaire, for direct or direct/indirect light emission, with on board or remote driver, for ceiling installation (with ceiling kit), suspended (with suspension kit and ceiling rose) or in-line configurations (with angle or linear joints, up to 1500W).

Highly versatile thanks to the many possible combinations given by the different modules that can be installed, the three-phase track, the opal or anti-glare optic for UGR<19 particularly suitable for VDU workstations.

Minimalistic-designed luminaire with a square-shaped and linear extruded aluminium body, available in single or double version, painted with epoxy powders in three finishes (white, black and grey).

Available in different sizes and related powers, in two gradations (3000K and 4000K) and, in some versions, with DALI protocol on request. As accessories to be ordered separately: end caps kit, diffusers and other accessories.



ROSONE ELETRIFICATO
ELECTRIFIED CEILING ROSE

KIT SOSPENSIONE
SUSPENSION KIT

KIT GIUNTO LINEARE
LINEAR JOINT KIT

KIT TESTATE TERMINALI
END CAPS KIT

KIT ATTACCO A SOFFITTO
CEILING CONNECTION KIT

CORPO ILLUMINANTE
LUMINAIRE

OTTICA ANTIRIFLESSO
ANTIREFLECTION OPTIC

UGR
<19

SCHERMO DIFFUSORE
DIFFUSER

PLAFONE
ESEMPIO DI COMPOSIZIONE
YEN MONO ALIMENTATORE A BORDO

CEILING
COMPOSITION EXAMPLE
YEN MONO ON BOARD DRIVE

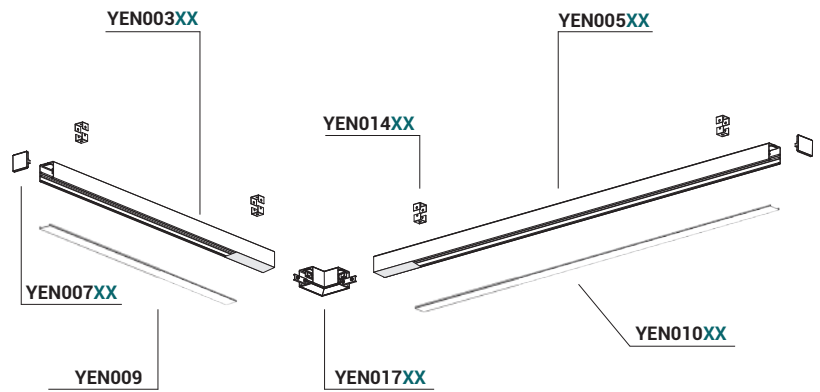

SOSPENSIONE
ESEMPIO DI COMPOSIZIONE
YEN MONO ALIMENTATORE REMOTO

SUSPENSION
COMPOSITION EXAMPLE
YEN MONO REMOTE DRIVE

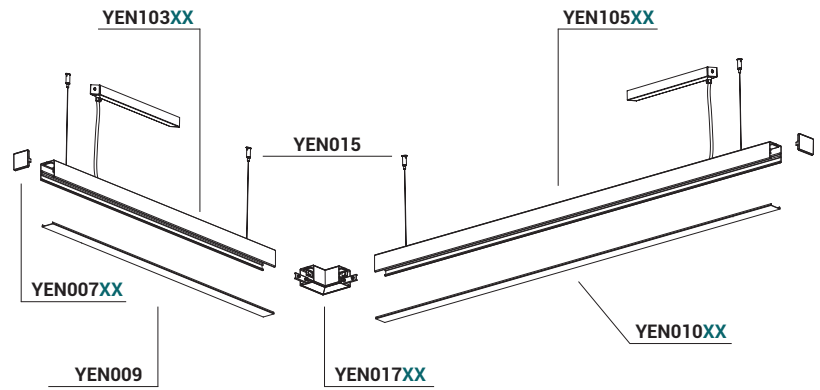

SOSPENSIONE
ESEMPIO DI COMPOSIZIONE
YEN DOPPIA EMISSIONE

SUSPENSION
COMPOSITION EXAMPLE
YEN DIRECT-INDIRECT LIGHT

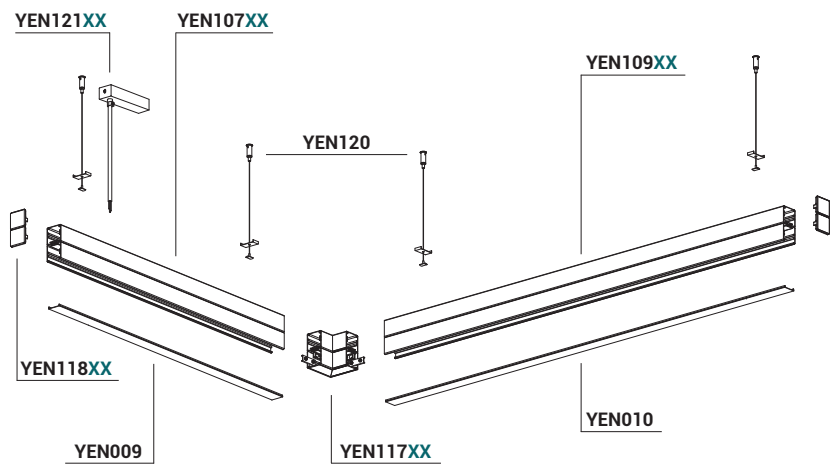

YEN MONO

ALIMENTATORE A BORDO ON BOARD DRIVER

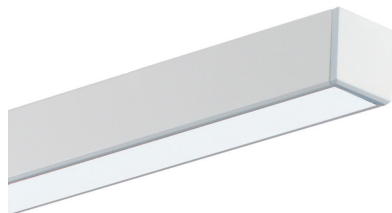

| Codice Code | CCT | Flusso lm Flux lm | Potenza Wattage | Dimensioni mm Dimensions mm |
|-----------------|-------|----------------------|--------------------|--------------------------------|
| YEN003XX | 3000K | 3412 | 24W | 1430 x 46 x 46 |
| YEN004XX | 4000K | 3573 | 24W | 1430 x 46 x 46 |
| YEN005XX | 3000K | 5118 | 36W | 1970 x 46 x 46 |
| YEN006XX | 4000K | 5360 | 36W | 1970 x 46 x 46 |

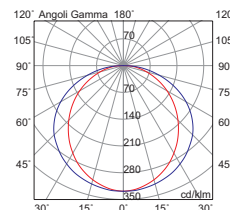
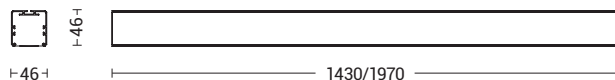

Testate di chiusura, schermo, kit fissaggio, rosone e giunti da ordinare separatamente.

End caps, diffuser, fixing kit, ceiling rose and joints to be ordered separately.

ALIMENTATORE REMOTO REMOTE DRIVER

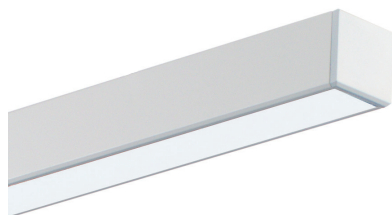

| Codice Code | CCT | Flusso lm Flux lm | Potenza Wattage | Dimensioni mm Dimensions mm |
|-----------------|-------|----------------------|--------------------|--------------------------------|
| YEN103XX | 3000K | 3412 | 24W | 1080 x 46 x 46 |
| YEN104XX | 4000K | 3573 | 24W | 1080 x 46 x 46 |
| YEN105XX | 3000K | 5118 | 36W | 1620 x 46 x 46 |
| YEN106XX | 4000K | 5360 | 36W | 1620 x 46 x 46 |

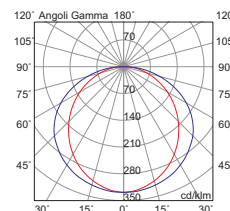
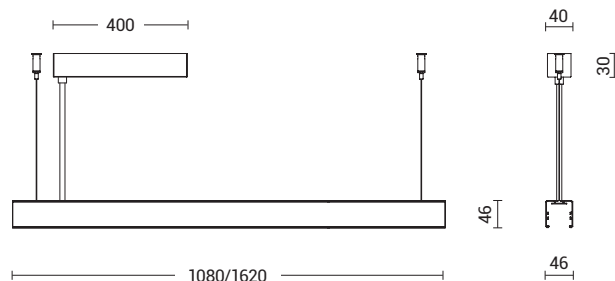

Testate di chiusura, schermo e giunti da ordinare separatamente.

End caps, diffuser and joints to be ordered separately.

Finiture Finishes



Accessori Accessories



versione **DALI** solo per i codici con alimentatore in remoto
DALI version for only codes with remote driver

Esempio Example
cod. **YEN105BDA**

YEN BINARIO

BINARIO TRIFASE THREEPHASE TRACK



| Codice Code | Dimensioni mm Dimensions mm |
|-----------------|--------------------------------|
| YEN101XX | 1080 x 46 x 46 |
| YEN102XX | 1620 x 46 x 46 |

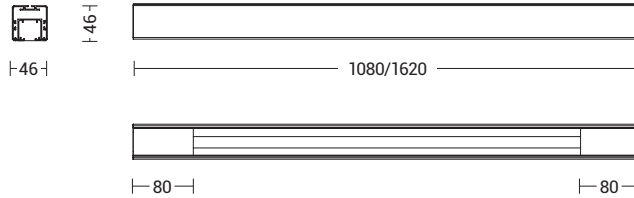

Testate di chiusura terminali, kit fissaggio e giunti da ordinare separatamente.

End caps, fixing kit and joints to be ordered separately.

PROIETTORI INSTALLABILI SU YEN BINARIO TRIFASE SPOTLIGHTS THAT CAN BE MOUNTED ON YEN THREE-PHASE TRACK



Finiture Finishes



YEN DOPPIO

BIEMISSIONE
DIRECT-INDIRECT LIGHT

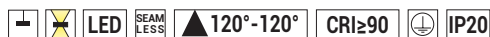

| Codice Code | CCT | Flusso lm Flux lm | Potenza Wattage | Dimensioni mm Dimensions mm |
|-----------------|-------|-------------------|-----------------|-----------------------------|
| YEN107XX | 3000K | 3412+1706 | 24W+12W | 1080 x 46 x 92 |
| YEN108XX | 4000K | 3573+1787 | 24W+12W | 1080 x 46 x 92 |
| YEN109XX | 3000K | 5118+3412 | 36W+24W | 1620 x 46 x 92 |
| YEN110XX | 4000K | 5360+3573 | 36W+24W | 1620 x 46 x 92 |

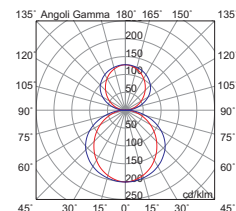
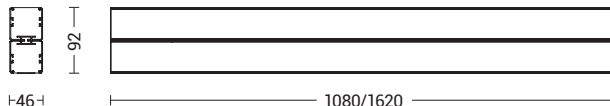

Testate di chiusura, schermo, kit fissaggio, rosone e giunti da ordinare separatamente. su richiesta versione monoemissione.

End caps, diffuser, fixing kit, ceiling rose and joints to be ordered separately. Mono-emission version on request.



Finiture Finishes



Accessori Accessories



versione DALI per tutti i codici
DALI version for all codes

Esempio Example
cod. **YEN107BDA**

**ACCESSORI
ACCESSORIES**

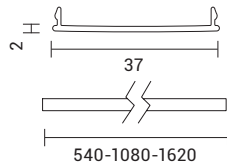
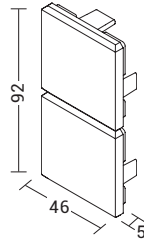
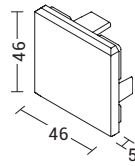

UGR<19

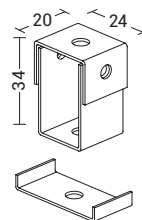
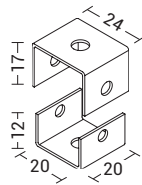
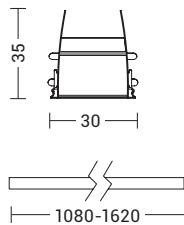

Codice
Code

YEN007XX

Coppia di testate in pressofusione di alluminio, verniciate. Da usare su moduli singoli o sugli ultimi della linea per Sistemi YEN MONO e MONO BINARIO.

Pair of end caps in die-cast aluminium, powder coated. To be used on single modules or on the last modules of the line for YEN MONO and YEN MONO BINARIO System.

Codice
Code

YEN118XX

Coppia di testate in pressofusione di alluminio, verniciate. Fissaggio ad innesto con viti. Da usare su moduli singoli o sugli ultimi della linea per Sistemi YEN DOPPIO.

Pair of end caps in die-cast aluminium, powder coated. Clip on fixture with screws. To be used on single modules or on the last modules of the line for YEN DOPPIO System.

Codice
Code

YEN008 12W

YEN009 24W

YEN010 36W

Schermo diffusore in policarbonato opale. Fissaggio a scatto. Permette di ottenere un grado di protezione IP40. Per Sistemi YEN MONO e DOPPIO.

Opal diffuser polycarbonate diffuser, snap on fixture. Allows IP40 protection degree of the fitting. For YEN MONO and DOPPIO System.

Codice
Code

YEN012 24W

YEN013 36W

Ottica antiriflesso in alluminio satinato accoppiata a schermo microprismato. Permette di ridurre l'abbagliamento e di raggiungere un UGR<19. Per Sistema YEN MONO e DOPPIO.

Matt aluminium antireflection optic with microprismatic diffuser. Reduces glare, achieving UGR<19. For YEN mono and DOPPIO System.

Codice
Code

YEN014XX

Coppia di staffe in lamiera verniciata. Permette di fissare i corpi direttamente a soffitto. Kit per Sistema YEN MONO e MONO BINARIO.

Pair of powder coated brackets. Allows the fitting to be installed directly on the ceiling. Kit for YEN MONO and TRACK System.

Codice
Code

YEN119XX

Coppia di staffe in lamiera verniciata. Permette di fissare i corpi direttamente a soffitto. Kit per Sistema YEN DOPPIO.

Pair of powder coated brackets. Allows the fitting to be installed directly on the ceiling. Kit for YEN DOPPIO System.

YEN

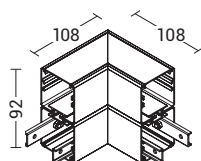
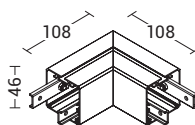
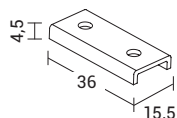
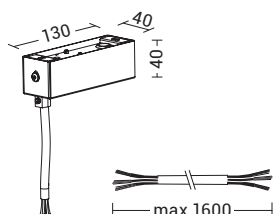
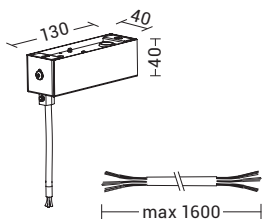
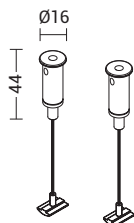

Codice
Code

YEN015 Kit sospensione MONO Suspension kit MONO

YEN120 Kit sospensione DOPPIO Suspension kit DOPPIO

Kit sospensione con coppia di rosoni in ottone cromato, con funi in acciaio 1500mm. Dispositivo per regolazione millimetrica. Carico massimo 7Kg per fune. Per Sistema MONO, MONO BINARIO, DOPPIO. Suspension kit with pair of brass chrome ceiling rose, with wire ropes 1500mm. Device for millimetric regulation. Maximum load 7Kg per rope. For YEN MONO, TRACK MONO and DOPPIO System.

Codice
Code

YEN121XX

Rosone elettrificato per sospensione ON-OFF, quadrato in lamiera verniciata con morsetto e cavo di alimentazione trasparente (3x1,5mm²), lunghezza max 1600mm.

Electrified ceiling rose for ON-OFF suspension, square powder coated sheet steel ceiling rose with clip and transparent power cable (3x1,5mm²), max length 1600mm.

Codice
Code

YEN122XX

Rosone elettrificato per sospensione DALI, quadrato in lamiera verniciata con morsetto e cavo di alimentazione trasparente (5x1,5mm²), lunghezza max 1600mm.

Electrified ceiling rose for DALI suspension, square powder coated sheet steel ceiling rose with clip and transparent power cable (5x1,5mm²), max length 1600mm.

Codice
Code

YEN016

Kit giunto lineare a scomparsa per il Sistema MONO, MONO BINARIO e DOPPIO. In lamiera di acciaio zincato. Fissaggio con viti. Permette di realizzare una giunzione "invisibile" di due corpi in linea.

Invisible linear joint kit for YEN MONO, TRACK YEN AND DOPPIO System. Galvanized steel sheet joint. Fixed with screws. Allows the creation of an "unseen" joint between two linear fittings.

Codice
Code

YEN017XX

Giunto angolare a "L" cieco per MONO e MONO BINARIO. Permette di realizzare una giunzione a 90° tra due corpi. Giunti lineari in dotazione.

"L" blank angle joint for YEN MONO and TRACK YEN. Designed to create a 90° joint between two fittings. Linear joints included.

Codice
Code

YEN117XX

Giunto angolare a "L" cieco per il Sistema DOPPIO. Permette di realizzare una giunzione a 90° tra due corpi. Giunti lineari in dotazione.

"L" blank angle joint for DOPPIO System. Designed to create a 90° joint between two fittings. Linear joints included.

Finiture Finishes



B



GR



N