

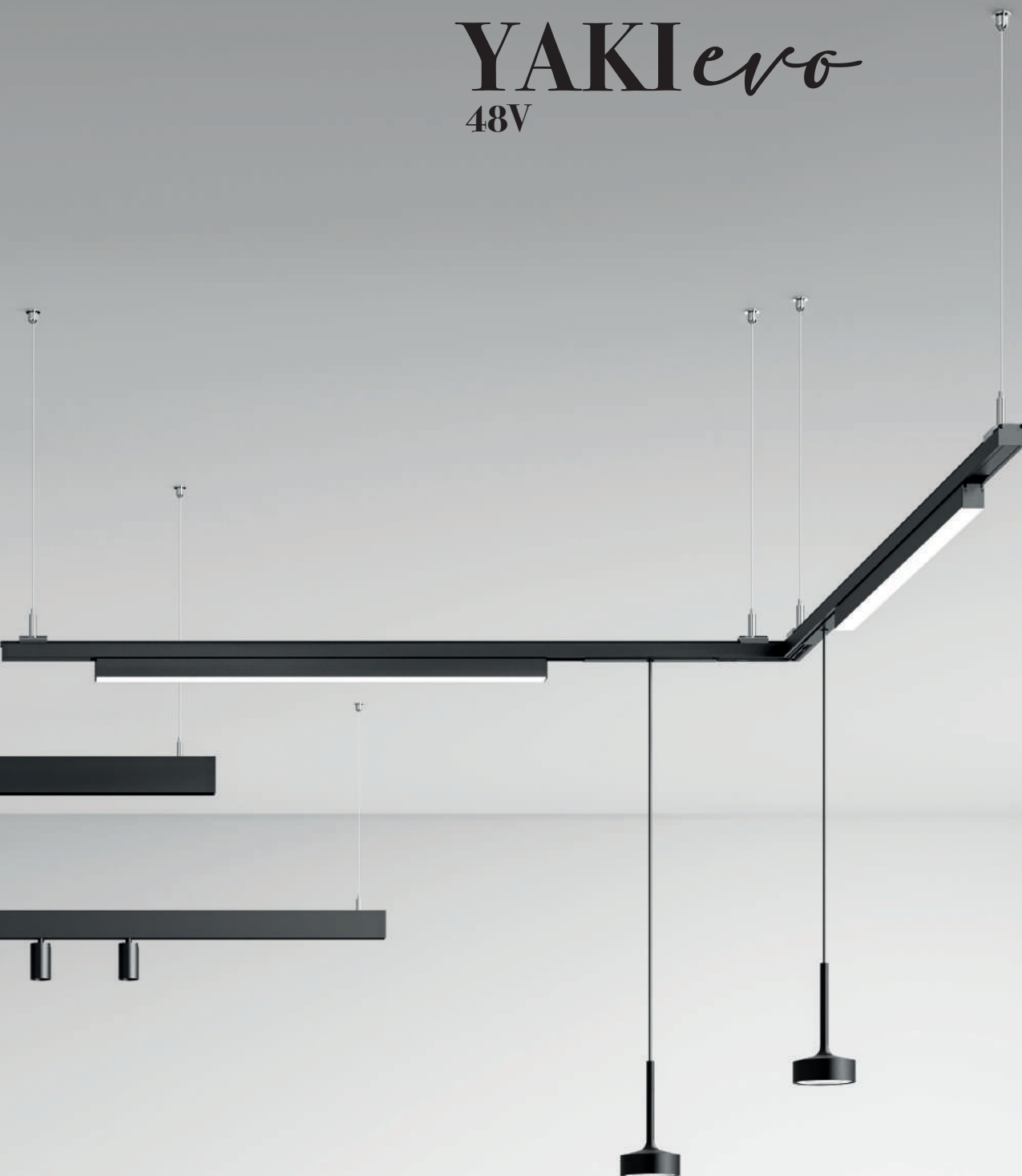

YAKI *evo*

48V

Restyle



Binario a 4 conduttori 48V con sezione quadrata applicabile ad incasso rasato, a parete, plafone e a sospensione con la possibilità di realizzare una doppia emissione di luce per un'illuminazione ad alte prestazioni.

48V track luminaire with square section for recessed, wall, ceiling and suspended installation. with the possibility of double light emission for high-performance lighting.







YAKILINEARE

Elemento LED lineare in pressofusione di alluminio con diffusore opale per illuminazione diffusa e per creare suggestive linee di luce che attraversano gli ambienti e definiscono gli spazi.

Linear LED element in die-cast aluminum with opal diffuser for diffused lighting and to create suggestive lines of light that cross the environments and define the spaces.



YAKISPOT

Proiettori LED orientabili di forma tonda per un'illuminazione puntuale, essenziale e solo dove serve.

Round shape LED adjustable spotlight for precise and essential illumination and only where needed.



YAKISPOT

Tre faretti LED con tre misure e relative potenze per ogni stile: versione miniaturizzata per un concentrato di tecnologia e design, versione dalle medie dimensioni per effetti luminosi con prestazioni ad alto livello, una versione più grande per una resa efficace, importante e precisa.

Three LED spotlights with three sizes and related powers for each style: miniature version for a concentrate of technology and design, medium-sized version for lighting effects with high-level performance, a larger version for effective performance, important and precise.

**HOLE**

L'eleganza del proiettore HOLE unita alla praticità e versatilità dell'installazione a binario per illuminare ogni ambiente in modo armonico, efficace e contemporaneo.

The elegance of the HOLE spotlight combined with the practicality and versatility of the track installation to illuminate every environment in a harmonious, effective and contemporary way.

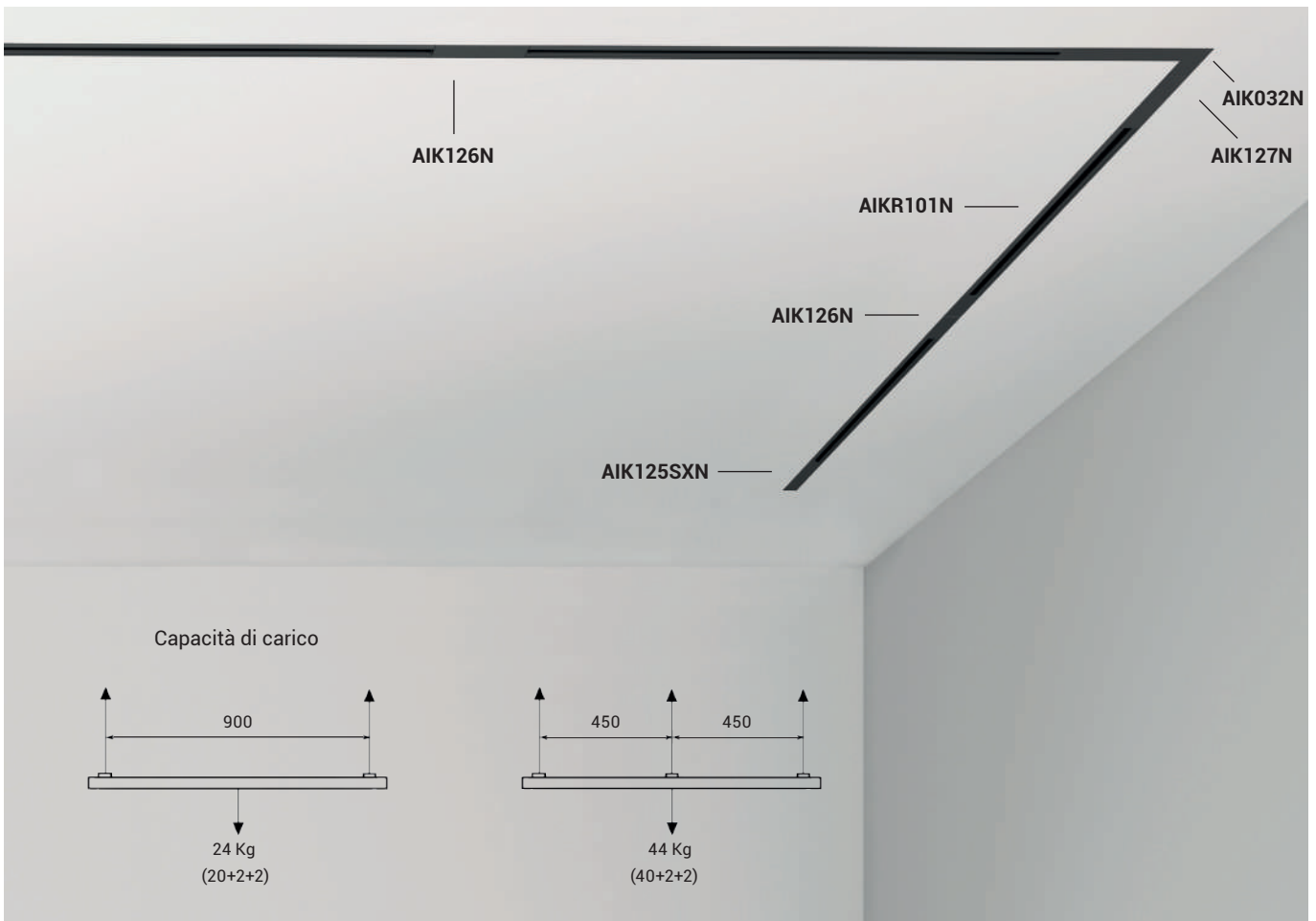
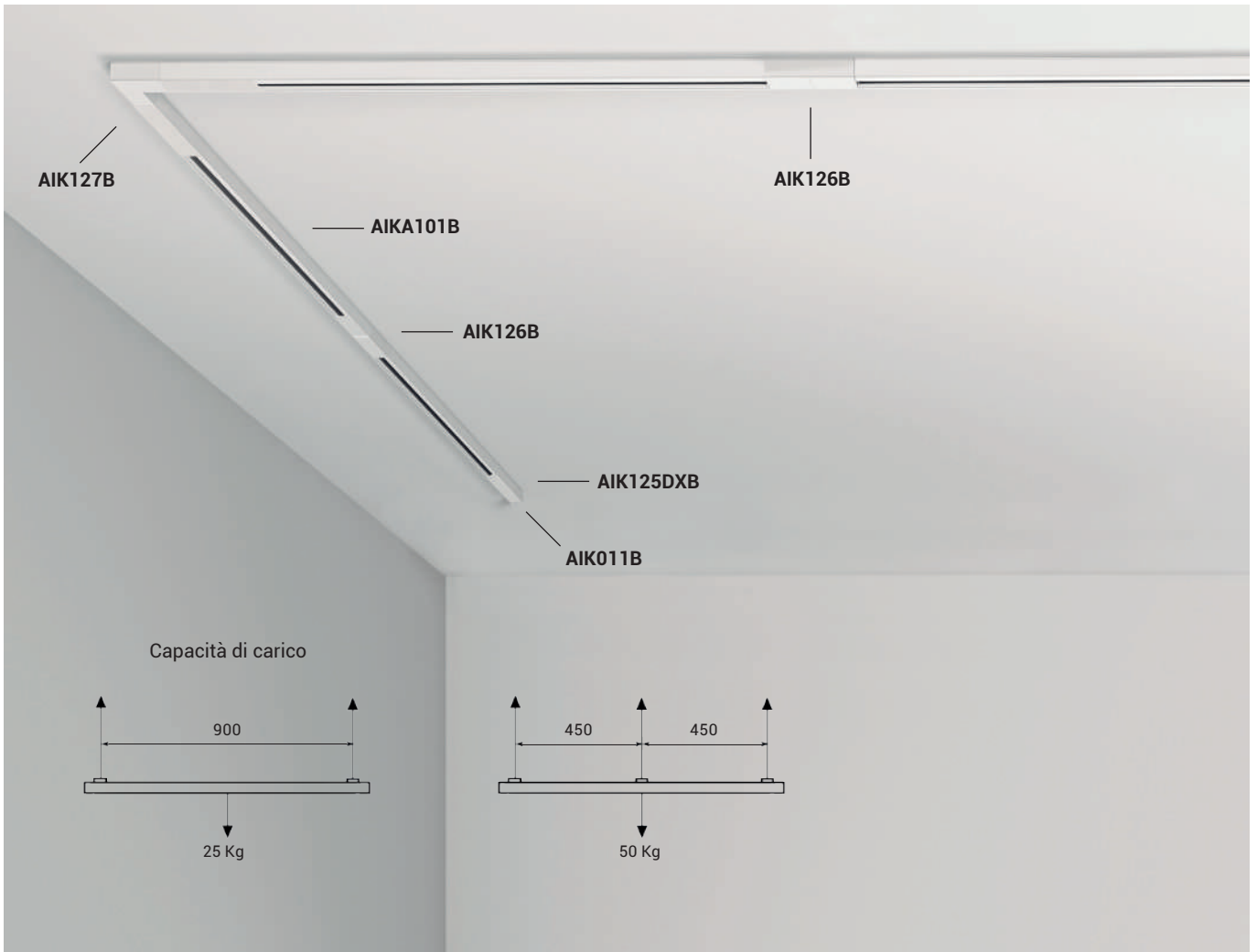

YAKI^{evo}

48V

S

STANDARD
PARETE/PLAFONE/SOSPENSIONE
WALL/CEILING/SUSPENSION

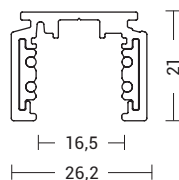
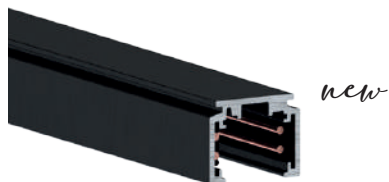

Codice Code	Dimensioni mm Dimensions mm
AIKA101XX	26,2 x 21 x 1000
AIKA201XX	26,2 x 21 x 2000



Restyle

FR

RASATO FRAMELESS
PARETE/PLAFONE
WALL/CEILING

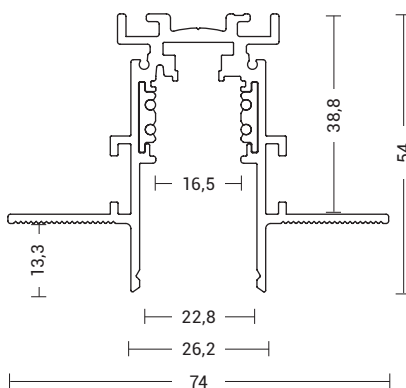
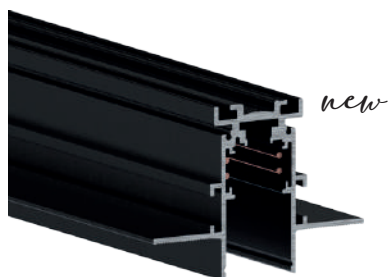

Codice Code	Dimensioni mm Dimensions mm
AIKR101N	74 x 54 x 1000
AIKR201N	74 x 54 x 2000

**H**

H DOPPIA EMISSIONE H DOUBLE EMISSION
SOSPENSIONE
SUSPENSION

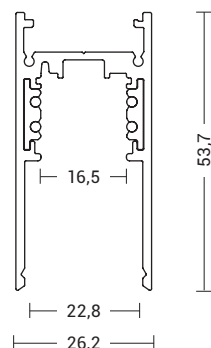

Codice Code	Dimensioni mm Dimensions mm
AIKH101XX	26,2 x 53,7 x 1000
AIKH201XX	26,2 x 53,7 x 2000



Finiture Finishes

**N**

per tutti i codici
for all codes

**B**

solo per i codici:
only for codes:
AIKA101
AIKA201
AIKH101
AIKH201

ACCESSORI ACCESSORIES

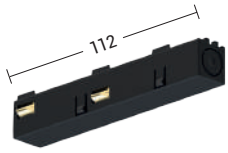

Codice
Code

AIK125SXXX sinistro left S FR H

AIK125DXXX destro right S FR H

Testata di alimentazione sinistra o destra in policarbonato.
Polycarbonate left or right head feed.

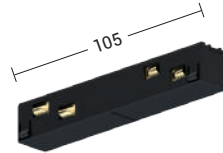

Codice
Code

AIK126XX S FR H

Giunto passante in policarbonato.
Polycarbonate jointing connector.

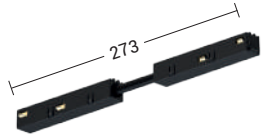

Codice
Code

AIK128XX S FR H

Giunto flessibile in policarbonato.
Polycarbonate flexible joint.

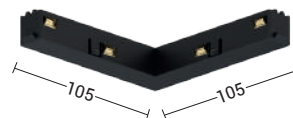

Codice
Code

AIK127XX S FR H

Giunto passante a "L" in policarbonato.
Polycarbonate "L" jointing connector.

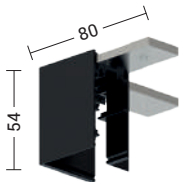

Codice
Code

AIK031XX H

Giunto meccanico a "L" per binario ad H.
Mechanical "L" connector for H track.

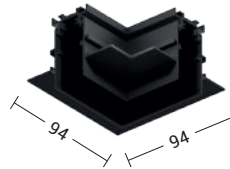

Codice
Code

AIK032N FR

Giunto meccanico a "L" per binario rasato.
Mechanical "L" connector for frameless recessed track.

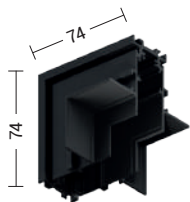

Codice
Code

AIK129N FR

Giunto meccanico a "L" parete/plafone per binario rasato.
Mechanical "L" connector for wall/ceiling and frameless recessed track.



Codice
Code

AIK030XX 25x7x3000 FR H

Cover di chiusura in PMMA per binario ad H e rasato.
PMMA track cover for H and frameless recessed track.



Codice
Code

AIK029OP 28x12x3000 FR H

Schermo opalino in policarbonato per binario ad H.
Polycarbonate opal diffuser for H track.

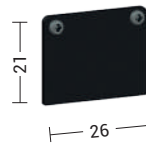

Codice
Code

AIK011XX S

Terminale di chiusura in metallo per binario standard.
Metal end cap for standard track.



Codice
Code

AIK014XX S

Staffa corta per sospensione per binario standard.
Short bracket for suspension for standard track.



Codice
Code

AIK111XX FR H

Terminale di chiusura in metallo per binario ad H e rasato.
Metal end cap for frameless recessed and H track.

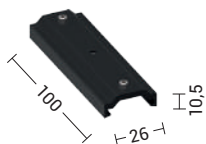

Codice
Code

AIK015XX S

Staffa in alluminio per giunzione in fila continua per binario standard.
Die-cast aluminium bracket for in-line configurations.

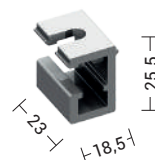

Codice
Code

AIK022 S H

Staffa bianca per fissaggio a soffitto della sospensione.
White bracket for ceiling fixing of the suspension.

YAKI *evo*

48V

Restyle

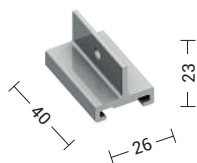

Codice
Code

AIK018

S

Staffa in alluminio corta a "T" per sospensione.
Alluminium short-pendant "T" bracket for suspension.

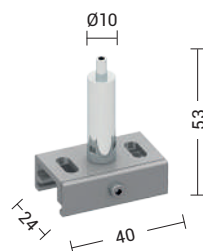

Codice
Code

AIK013

S

Staffa in alluminio con tenditore automatico.
Die-cast aluminium bracket with automatic gripper.



Codice
Code

AIK035

H

Kit completo per fissaggio a sospensione, tenditore a vite, rosone metallico, filo in acciaio Ø 1,5mm L3000mm.
Fixing kit for suspension, screw gripper, metal ceiling rose. steel cable Ø 1,5mm L3000mm.



Codice
Code

AIK019

Dimensioni mm
Dimensions mm

AIK020

Ø1,5x2000

S H

AIK021

Ø1,5x3000

S H

Cavo in acciaio Ø 1,5 mm per sospensione.
Steel cable Ø 1,5 mm for suspension.



Codice
Code

AIK023XX

S H

Rosone plastico per filo in acciaio Ø 1,5 mm.
Plastic ceiling rose for steel cable Ø 1,5 mm.



Codice
Code

AIK024

S H

Rosone per fissaggio a soffitto.
Round ceiling rose for ceiling installation.

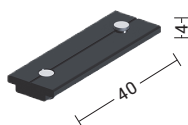

Codice
Code

AIK016

FR

Staffa di rinforzo per giunto passante per binario frameless.
Reinforcing bracket for jointing connector for frameless recessed track.

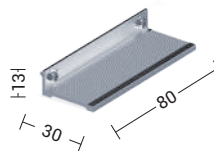

Codice
Code

AIK017

FR

Staffa per applicazione frameless.
Bracket for frameless installation.



Codice
Code

TS.805-100 100W

S FR H

TS.805-250 250W

S FR H

Alimentatore invisibile integrato a 48V. Cavo 3mt.
Integrated invisible power supply 48V. Cable 3mt.

CLICK!
Inserimento a pressione
Pressure insertion



Codice
Code

TS.801-25

S FR H

Alimentatore con uscita in tensione continua 48V.
Constant current 48V LED driver.
220-240V/50-60Hz 48V max 25 W



Codice
Code

TS.801-60

S FR H

Alimentatore con uscita in tensione continua 48V.
Constant current 48V LED driver.
220-240V/50-60Hz 48V max 60 W



Codice
Code

TS.801-100

S FR H

Alimentatore con uscita in tensione continua 48V.
Constant current 48V LED driver.
220-240V/50-60Hz 48V max 100 W

Finiture Finishes

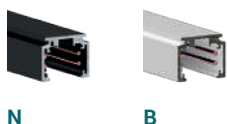

Accessori Accessories



AIK012
Tronchese per taglio conduttori del binario
Cutting tool for track conductors

YAKISPOT

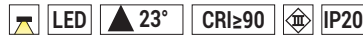
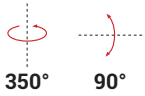
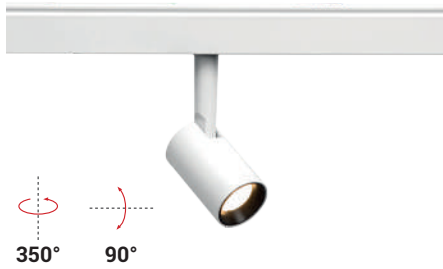

Codice Code	CCT	Flusso lm Flux lm	Potenza Wattage	Dimensioni mm Dimensions mm
YAK103XX	3000K	220	2W	Ø26 x 167 x 94

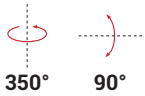
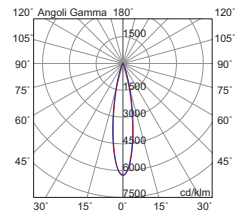
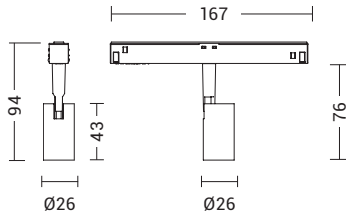

Codice Code	CCT	Flusso lm Flux lm	Potenza Wattage	Dimensioni mm Dimensions mm
YAK105XX	3000K	640	6,6W	Ø40 x 167 x 123

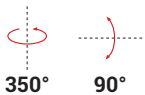
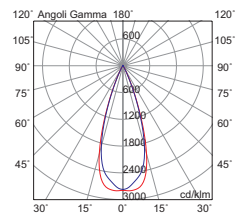
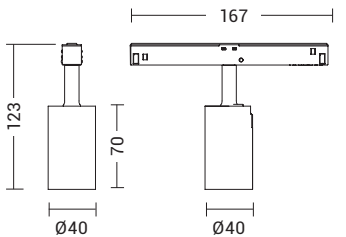

Codice Code	CCT	Flusso lm Flux lm	Potenza Wattage	Dimensioni mm Dimensions mm
YAK112XX	3000K	1600	14W	Ø50 x 167 x 140

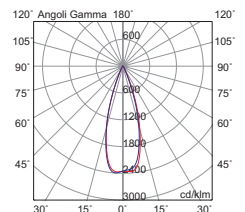
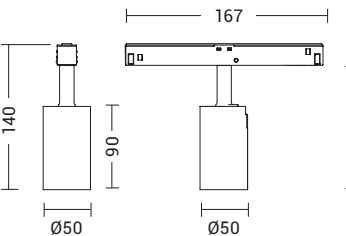

Finiture Finishes

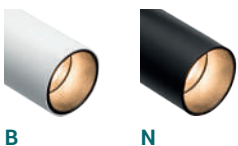

Accessori Accessories

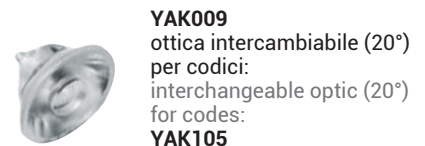
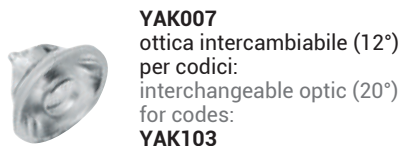

YAKI *evo*

48V

HOLE



YAK107XX
struttura nero
black structure

YAK207XX
struttura bianco
white structure



Codice Code	CCT	Flusso lm Flux lm	Potenza Wattage	Dimensioni mm Dimensions mm
YAK107XX	3000K	670	7W	Ø75 x 167 x 88
YAK207XX	3000K	670	7W	Ø75 x 167 x 88

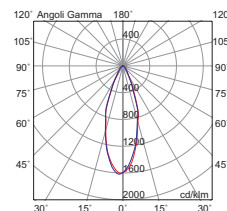
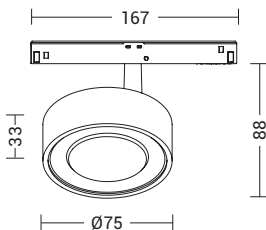

Restyle



HOL004XX
struttura nero
black structure

HOL104XX
struttura bianco
white structure



Codice Code	CCT	Flusso lm Flux lm	Potenza Wattage	Dimensioni mm Dimensions mm
HOL004XX	3000K	670	7W	Ø75 x 135
HOL104XX	3000K	670	7W	Ø75 x 135

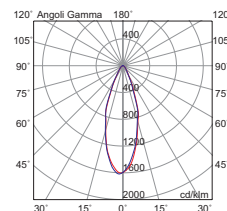
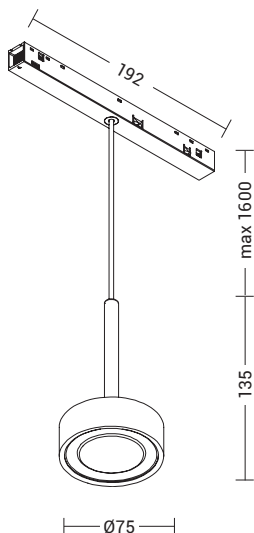

Finiture Anello Ring Finishes

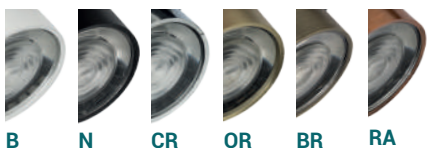

Accessori Accessories



MT.YUG60
ottica intercambiabile (60°)
interchangeable optic (60°)

Altre applicazioni Other applications

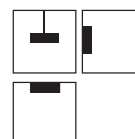

Sospensione Suspension
Plafone Ceiling
Parete Wall
p.51

MINI AXIOM

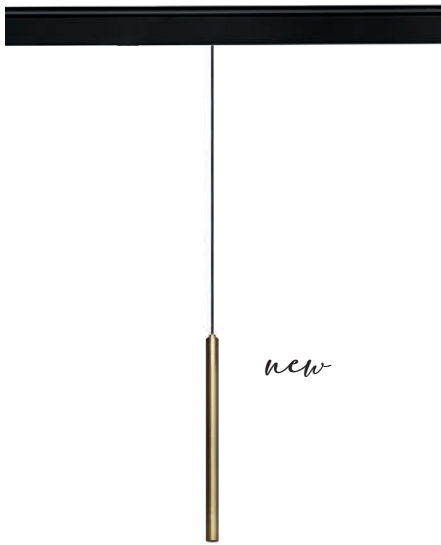

LED
 40°
 CRI≥80
 IP20

Codice Code	CCT	Flusso lm Flux lm	Potenza Wattage	Dimensioni mm Dimensions mm
AXI105XX	3000K	200	3W	Ø18 x 500

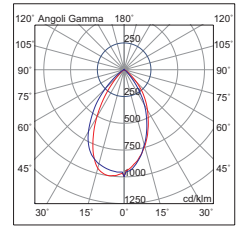
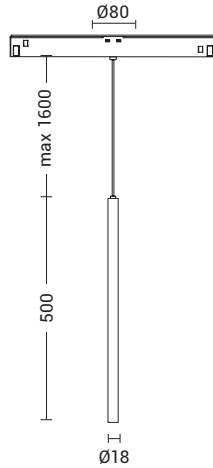

AXIOM



LED
 45°
 CRI≥80
 IP20

Codice Code	CCT	Flusso lm Flux lm	Potenza Wattage	Dimensioni mm Dimensions mm
AXI101XX	3000K	700	7W	Ø46 x 250

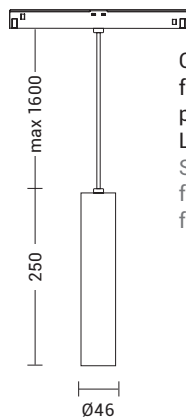

Cavo in trasparente PVC per la finitura **B** e cavo nero in tessuto per la finitura **N**
 Lunghezza max 1600mm
 Suspension cable in clear PVC for **B** finish and in fabric for **N** finish. Length max 1600mm.

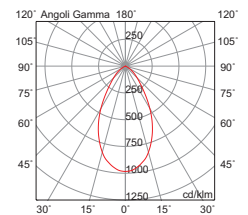

Finiture Finishes



per tutti i codici
for all codes



BZ

solo per il codice:
only for code:
AXI105

Altre applicazioni Other applications



Sospensione Suspension
MINI AXIOM p.69
AXIOM p.65

YAKI *evo*

48V

YAKILINEARE



LED
 30°
 CRI≥90
 IP20

Codice Code	CCT	Flusso lm Flux lm	Potenza W W	Dimensioni mm Dimensions mm
YAK101XX	3000K	1470	13W	565 x 22 x 25

Restyle

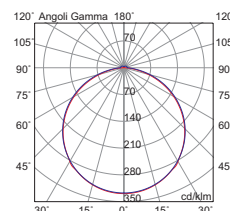
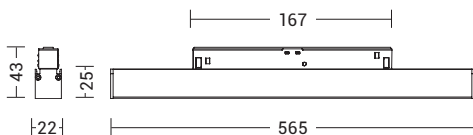

Finiture Finishes



B

N