



# SQUASH SQUASH PRO

MONOFASE MONOPHASE

Restyle



Binario monofase a tensione di rete 220V. Applicabile a parete, plafone, a incasso o a sospensione con appositi accessori. Realizzato in lega di alluminio estruso, conduttori in rame alloggiati in estrusi in PVC. Disponibile in tre dimensioni e in finiture bianco, nero o grigio a seconda delle versioni.

Monophase track, 220V. It can be installaed on the wall, ceiling, recessed or suspended with appropriate accessories. Made of extruded aluminum alloy, copper wires housed in extruded PVC. Available in three sizes and three finishes white, gray and black according to the versions.





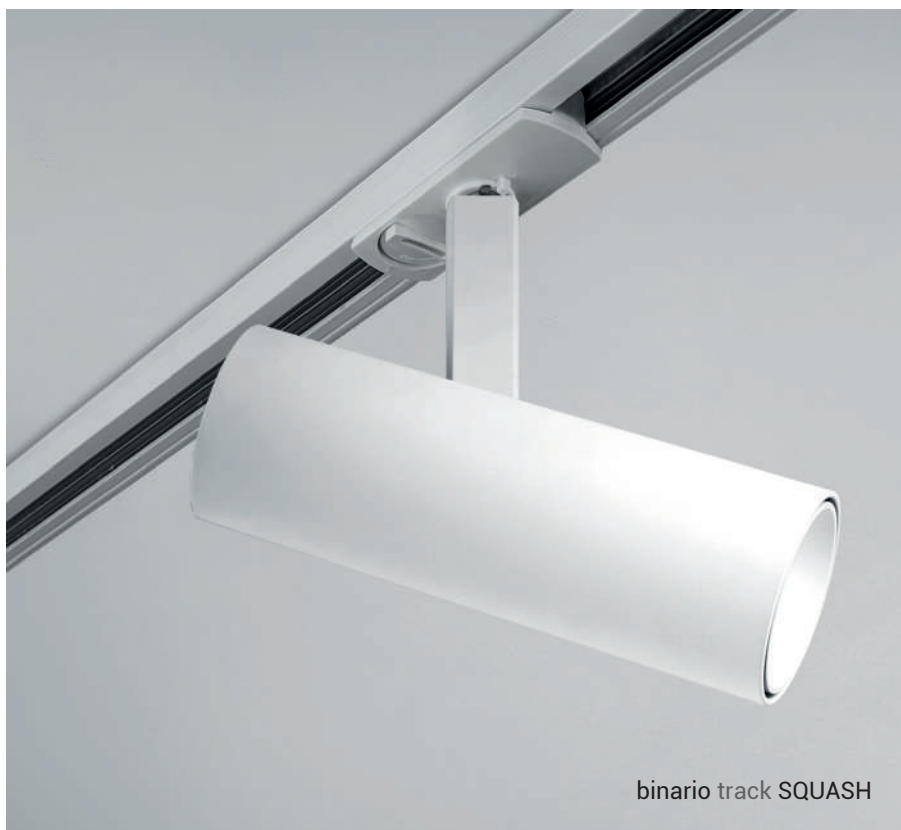

binario track SQUASH

**MAAR**

Proiettore LED ad alta efficienza da binario orientabile su due assi. Struttura in pressofusione di alluminio verniciato con polveri.

Ottica con apertura fascio di 36°, disponibili accessori (da ordinare separatamente) per variare il fascio luminoso a 12°, 24° e 60°. In virtù dell'ottima resa cromatica (CRI≥90) il prodotto è adatto per negozi ed ambienti retail, fornisce una luce omogenea e al contempo piacevole e priva di abbagliamento e ombre.

Disponibile in diverse potenze, in tre finiture (bianco, grigio e nero) e due temperature colore (3000K e 4000K).

High efficiency track-mounted LED projector adjustable on two axes.

Die-cast aluminium, powder coated.

Light beam lens 36°, other lenses (to be ordered separately) to adjusted the light beam at 12°, 24° and 60°. Thanks to its excellent colour rendering (CRI≥90) it is also suitable for shops and retail areas. Provides a uniform light emission without glare and shadows.

Available in different powers, in three finishes (white, grey and black) and two gradations (3000K and 4000K).

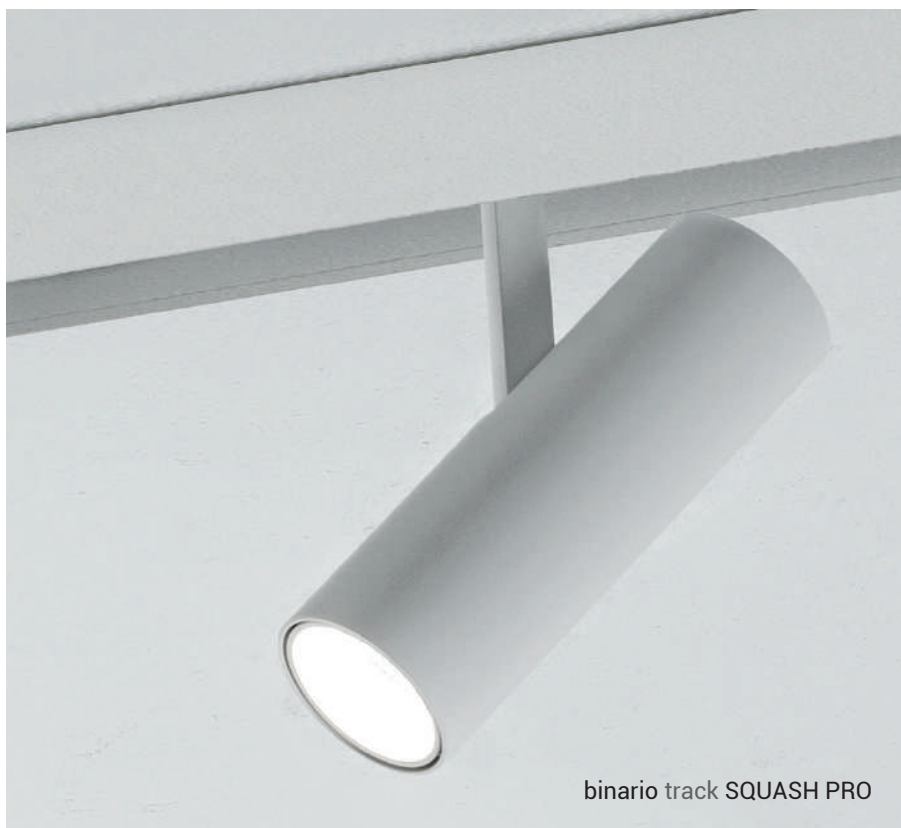

binario track SQUASH PRO



binario track SQUASH

### MANUKA

Proiettore da binario orientabile su due assi con attacco GU10 che consente di montare lampadina LED. Struttura in metallo. Disponibile in tre finiture (bianco, grigio e nero).

Grazie al suo design compatto, SQUASH PRO permette l'installazione arretrata dei proiettori andando a nascondere la loro struttura all'interno del profilo, con un ridotto impatto visivo del corpo illuminante e un effetto di estrema pulizia ed eleganza.

Track-mounted LED projector adjustable on two axes. GU10 lamp holder that allows mounting the LED. Metal body. Available in three finishes (white, grey and black).

Thanks to its compact design, SQUASH PRO allow the installation of the projectors backward to hide their structure inside the profile, with a reduced visual impact of the lighting body and an effect of extreme cleanliness and elegance.



binario track SQUASH PRO



**CORVINA**

Corpo illuminante a sospensione a con struttura a forma di cono realizzata in metallo laccato nei colori bianco, nero e oro satinato. Cablata con attacco GU10 che consente di montare lampadina LED.

Pendant luminaire with cone-shaped structure made in lacquered metal in white, black and satin gold colours. GU10 lamp holder that allows mounting the LED lamp.

**ASIA**

Corpo illuminante a sospensione dalla forma conica in metallo verniciato a polveri disponibile in due finiture (bianco e nero) con interno bianco o oro satinato. Cablata con attacco E27 o E14 che consente di montare lampadina LED.

Pendant luminaire of conical shape in power painted metal, available in two finishes (black or white) with interior in white or satin gold finish. E27 or E14 lamp holder that allows mounting the LED lamp.



**AXIOM**

Corpo illuminante a sospensione con COB LED o con attacco GU10 che consente di montare lampadina LED.

Struttura in pressofusione di alluminio verniciato con polveri epossidiche ad elevata resistenza, diametro del diffusore ridotto per un'emissione di luce concentrata (50°-15W tot.).

Disponibile in due finiture (bianco e nero).

COB LED suspension lamp or GU10 lamp holder that allows mounting the LED lamp.

Die-cast aluminium body painted with high-resistant epoxy powders, reflector diameter for a spotlight beam (50°-15W tot.).

Available in two finishes (white and black).

**RABAB**

Proiettore doppio a binario orientabile in pressofusione di alluminio con attacco GU10 che consente di montare lampadina LED. Regolabile e orientabile.

Disponibile in due finiture: bianco e nero. Disponibile accessorio per attacco a parete/plafone (accessorio da ordinare separatamente).

Adjustable double track spotlight in die-cast aluminium with GU10 lamp holder that allows mounting the LED.

It can be tilted. Available in two finishes: white and black.

Wall/ceiling adapter available as accessory (to be ordered separately).

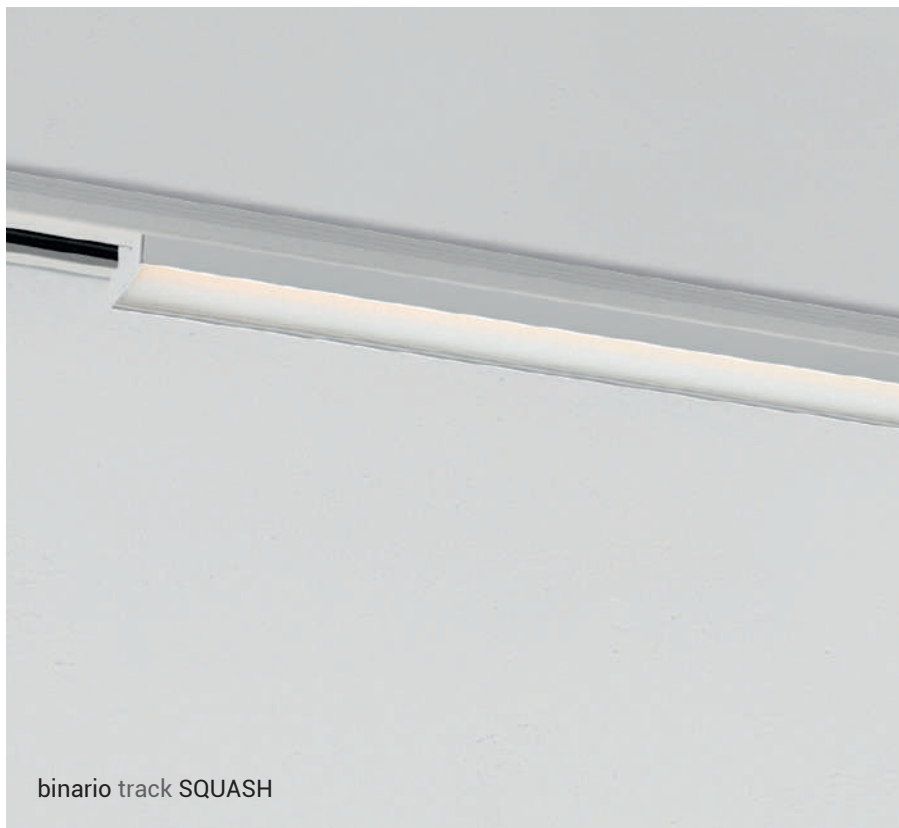

binario track SQUASH

## TELCO

Apparecchio LED lineare monofase, struttura in alluminio verniciato a polveri con diffusore in policarbonato microprismatico. Luce diffusa: illumina l'ambiente circostante in modo uniforme. L'ottima resa cromatica ( $CRI \geq 90$ ) lo rende perfetto per attività commerciali e ambienti retail, dove è necessario un'illuminazione omogenea, piacevole e priva di abbagliamento e ombre. Disponibile in due misure e relative potenze, in due finiture (bianco e nero), il prodotto è dotato di switch per la scelta della temperatura colore (3000K - 4000K).

LED linear luminaire, for direct light emission, powder-coated aluminum structure with microprismatic polycarbonate diffuser. Diffused light: illuminates the surroundings evenly. Its excellent color rendering ( $CRI \geq 90$ ) makes it perfect for commercial activities and retail environments, where homogeneous, pleasant and without glare and shadows lighting is required. Available in two sizes and related powers, in two finishes (white and black), the product is equipped with a switch for choosing the color temperature (3000K - 4000K).



binario track SQUASH PRO

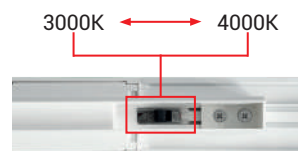

Installato su binario SQUASH PRO va in battuta con il profilo: il corpo illuminante rimane nascosto all'interno del binario, con un ridotto impatto visivo.

Installed on track SQUASH PRO, it's in line with the profile: the luminaire remains hidden inside the track, with reduced visual impact.

2 TEMPERATURE COLORE 2 POTENZE 2 COLORI EFFICIENZA ALTA RESA CROMATICA  
2 GRADATIONS 2 POWERS 2 FINISHES EFFICIENCY EXCELLENT COLOUR RENDERING

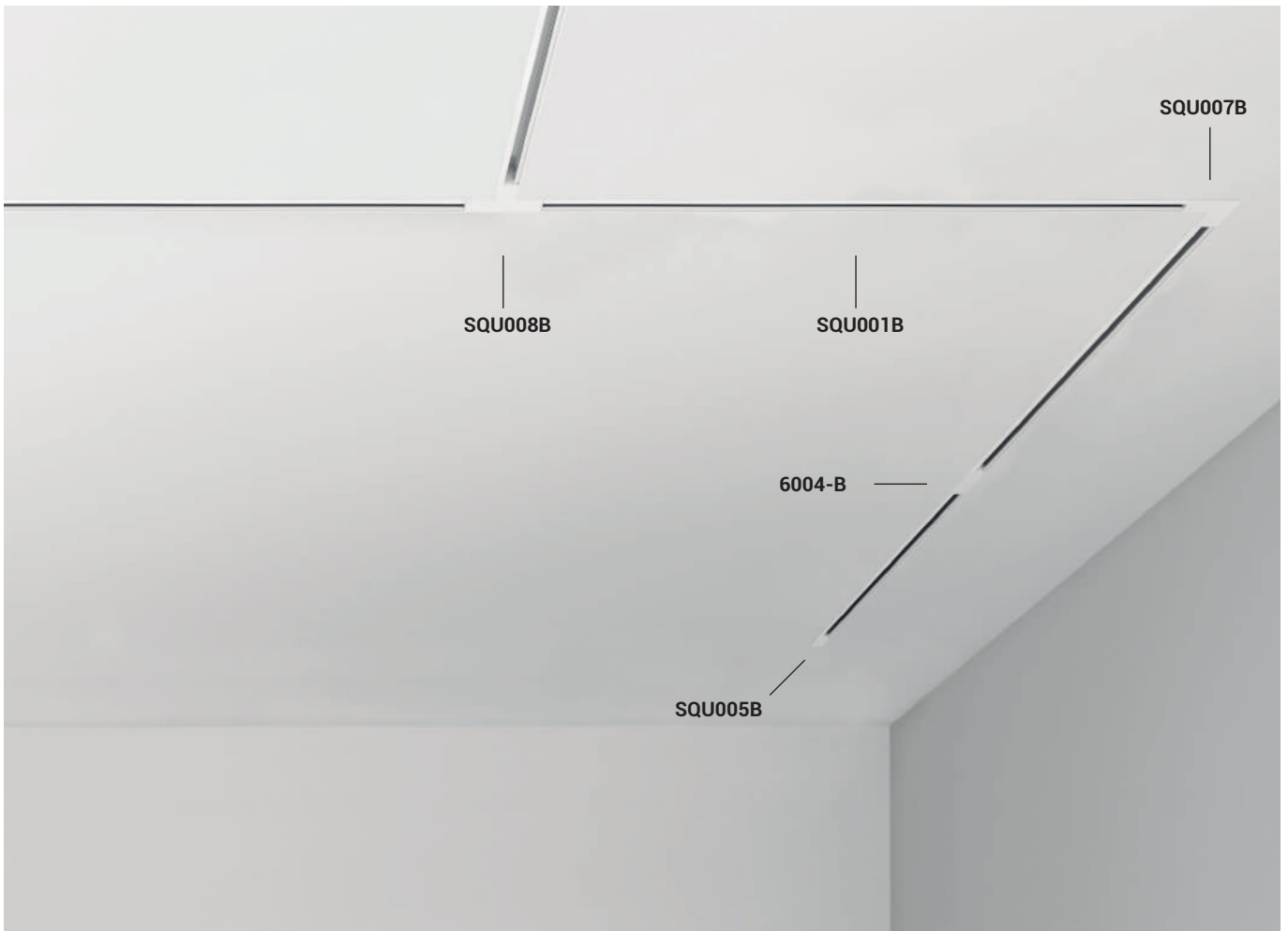

# SQUASH

## MONOFASE MONOPHASE

**S**

STANDARD  
PARETE/PLAFONE/SOSPENSIONE  
WALL/CEILING/SUSPENSION

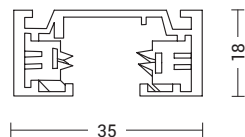

Codice Code	Dimensioni mm Dimensions mm
<b>6000-100-XX</b>	35 x 18 x 1000
<b>6000-200-XX</b>	35 x 18 x 2000
<b>6000-300-XX</b>	35 x 18 x 3000

**R**

INCASSO RECESSED  
PARETE/PLAFONE  
WALL/CEILING

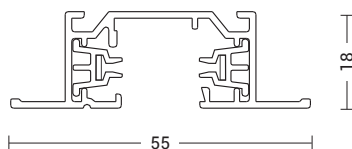

Codice Code	Dimensioni mm Dimensions mm
<b>SQU001B</b>	55 x 18 x 1000
<b>SQU002B</b>	55 x 18 x 2000
<b>SQU003B</b>	55 x 18 x 3000



# SQUASH PRO

## MONOFASE MONOPHASE

STANDARD  
PARETE/PLAFONE/SOSPENSIONE  
WALL/CEILING/SUSPENSION

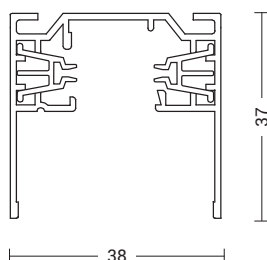

Codice Code	Dimensioni mm Dimensions mm
<b>SQU101XX</b>	38 x 37 x 1000
<b>SQU102XX</b>	38 x 37 x 2000
<b>SQU103XX</b>	38 x 37 x 3000



### Finiture Finishes

**B**

per tutti i codici  
for all codes

**N**

solo per i codici:  
only for codes:  
**SQU101**  
**SQU102**  
**SQU103**  
**6000-100**  
**6000-200**  
**6000-300**

**GR**

solo per i codici:  
only for codes:  
**6000-100**  
**6000-200**  
**6000-300**

## ACCESSORI ACCESSORIES



Codice  
Code

**6002-DX-XX**

S

Testata di alimentazione destra per binario Squash standard.  
End feed right for standard Squash track.



Codice  
Code

**6002-SX-XX**

S

Testata di alimentazione sinistra per binario Squash standard.  
End feed left for standard Squash track.

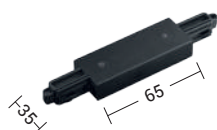

Codice  
Code

**6016-XX**

S

Testata di alimentazione centrale per binario Squash standard.  
Central feed for standard Squash track.



Codice  
Code

**6004-XX**

S

Giunto lineare passante per binario Squash standard.  
Linear jointing connector for standard Squash track.

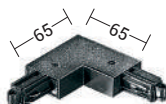

Codice  
Code

**6005-DX-XX**

S

Giunto a "L" destro per binario Squash standard.  
Right "L" joint for standard Squash track.

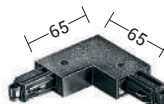

Codice  
Code

**6005-SX-XX**

S

Giunto a "L" sinistro per binario Squash standard.  
Left "L" joint for standard Squash track.

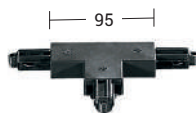

Codice  
Code

**6008-DX-XX**

S

Giunto a "T" destro per binario Squash standard.  
Right "T" joint for standard Squash track.

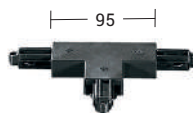

Codice  
Code

**6008-SX-XX**

S

Giunto a "T" sinistro per binario Squash standard.  
Left "T" joint for standard Squash track.

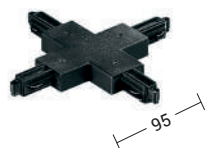

Codice  
Code

**6009-XX**

S

Giunto a "X" per binario Squash standard.  
"X" joint for standard Squash track.



Codice  
Code

**6010-XX**

S

Giunto flessibile per binario Squash standard.  
Flexible joint for standard Squash track.



Codice  
Code

**6014-XX**

S

Adattatore meccanico/elettrico per binario Squash standard.  
Mechanical/electric adaptor for standard Squash track.



Codice  
Code

**6003-XX**

S

Terminale di chiusura per binario Squash standard.  
End cap for standard Squash track.

# SQUASH

## MONOFASE MONOPHASE

Restyle

Codice  
Code

**SQU004B** destro right R  
**SQU005B** sinistro left R

Testata di alimentazione destra e sinistra per binario Squash incasso.  
End feed right and left for recessed Squash track.



Codice  
Code

**SQU006B** R

Giunto a "L" destro per binario Squash incasso.  
Right "L" joint for recessed Squash track.

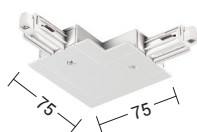

Codice  
Code

**SQU008B** R

Giunto a "T" destro per binario Squash incasso.  
Right "T" joint for recessed Squash track.

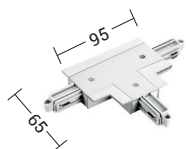

Codice  
Code

**6014-XX** R

Adattatore meccanico/elettrico per binario Squash incasso  
Mechanical/electric adaptor for recessed Squash track.



Codice  
Code

**SQU011** R

Attacco in metallo per installazione binario Squash incasso in battuta nel controsoffitto.  
Metal attachment connection for seating in the false ceiling the recessed Squash track.



Codice  
Code

**6023-XX** R

Tige per sospensione  
Suspension kit with pipe.



Codice  
Code

**6004-B** R

Giunto lineare passante per binario Squash incasso.  
Linear jointing connector for recessed Squash track.



Codice  
Code

**SQU007B** R

Giunto a "L" sinistro per binario Squash incasso.  
Left "L" joint for recessed Squash track.

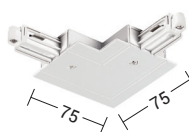

Codice  
Code

**SQU009B** R

Giunto a "T" sinistro per binario Squash incasso.  
Left "T" joint for recessed Squash track.

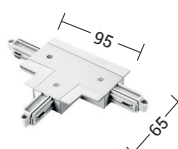

Codice  
Code

**SQU010B** R

Giunto passante a "X" per binario Squash incasso.  
"X" jointing connector for recessed Squash track.

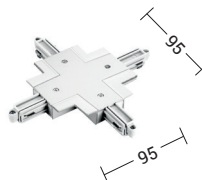

Codice  
Code

**6022-XX** R S

Cavo in acciaio Ø 1,5 mm per sospensione  
Steel cable Ø 1,5 mm for suspension.



Codice  
Code

**SQU110-B** R S

**SQU110-N** R S  
Copertura binario 1mt.  
Track cover 1mt

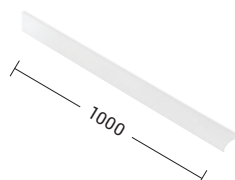

### Finiture Finishes



B

N

GR

## ACCESSORI ACCESSORIES

# SQUASH PRO

## MONOFASE MONOPHASE

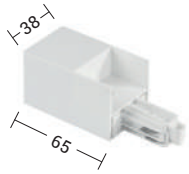

Codice  
Code

**SQU106XXDX**

Testata di alimentazione destra per binario Squash PRO.  
End feed right for Squash PRO track.

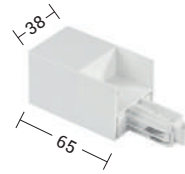

Codice  
Code

**SQU106XXSX**

Testata di alimentazione sinistra per binario Squash PRO.  
End feed left for recessed Squash PRO track.



Codice  
Code

**SQU104XX**

Giunto lineare passante per binario Squash PRO.  
Linear jointing connector for Squash PRO track.

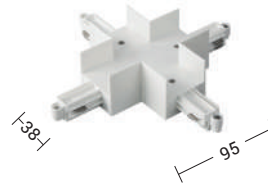

Codice  
Code

**SQU105XX**

Giunto passante a "X" per binario Squash PRO.  
"X" jointing connector for Squash PRO track.

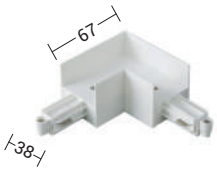

Codice  
Code

**SQU107XXDX**

Giunto a "L" destro per binario Squash PRO.  
Right "L" joint for Squash PRO track.

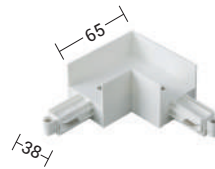

Codice  
Code

**SQU107XXSX**

Giunto a "L" sinistro per binario Squash PRO.  
Left "L" joint for Squash PRO track.

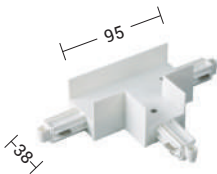

Codice  
Code

**SQU108XXDX**

Giunto a "T" destro per binario Squash PRO.  
Right "T" joint for Squash PRO track.

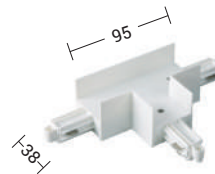

Codice  
Code

**SQU108XXSX**

Giunto a "T" sinistro per binario Squash PRO.  
Left "T" joint for Squash PRO track.



Codice  
Code

**SQU109XX**

Terminale di chiusura per binario Squash PRO.  
End cap for Squash PRO track.



Codice  
Code

**6022-XX**

Dimensioni mm  
Dimensions mm  
Cavo in acciaio Ø 1,5 mm per sospensione  
Steel cable Ø 1,5 mm for suspension.



Codice  
Code

**6023-XX**

Tige per sospensione  
Suspension kit with pipe.

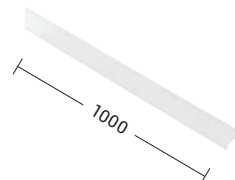

Codice  
Code

**SQU110-XX**

Copertura binario 1mt.  
Track cover 1mt

### Finiture Finishes

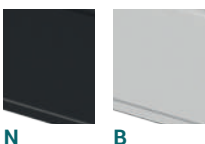

N

B

MAAR

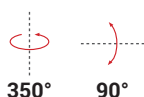

# SQUASH/SQUASH PRO

## MONOFASE MONOPHASE

LED 36° CRI≥90 IP20

Codice Code	CCT	Flusso lm Flux lm	Potenza W W	Dimensioni mm Dimensions mm
<b>LAU001XX</b>	3000K	880	10W	Ø62 x 165 x 205
<b>LAU002XX</b>	4000K	920	10W	Ø62 x 165 x 205

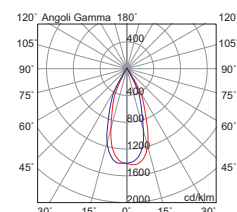
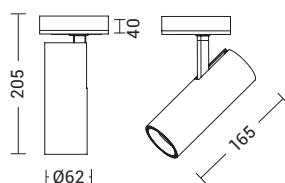

Restyle

LED 36° CRI≥90 IP20

Codice Code	CCT	Flusso lm Flux lm	Potenza W W	Dimensioni mm Dimensions mm
<b>LAU003XX</b>	3000K	1750	20W	Ø72 x 178 x 221
<b>LAU004XX</b>	4000K	1840	20W	Ø72 x 178 x 221

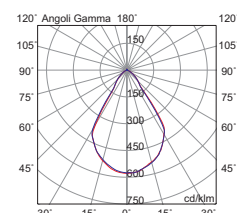
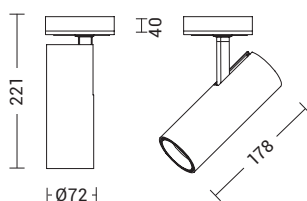

LED 36° CRI≥90 IP20

Codice Code	CCT	Flusso lm Flux lm	Potenza W W	Dimensioni mm Dimensions mm
<b>LAU005XX</b>	3000K	2840	32W	Ø85 x 235 x 297
<b>LAU006XX</b>	4000K	2990	32W	Ø85 x 235 x 297

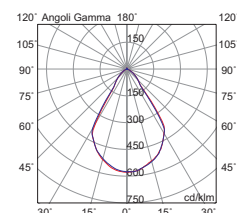
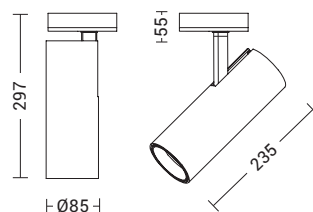

### Finiture Finishes



### Accessori Accessories



**MAA112OT(12°)**  
**MAA124OT(24°)**  
 ottica intercambiabile per cod:  
 interchangeable optic for:  
**LAU001-LAU002**

**MAA212OT(12°)**  
**MAA224OT(24°)**  
**MAA260OT(60°)**  
 ottica intercambiabile per cod:  
 interchangeable optic for:  
**LAU003-LAU004**

**MAA312OT(12°)**  
**MAA324OT(24°)**  
**MAA360OT(60°)**  
 ottica intercambiabile per cod:  
 interchangeable optic for:  
**LAU005-LAU006**



## MANUKA

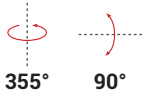

Codice  
Code

**CON001XX**



GU10

Potenza  
Wattage

1x50W max

Dimensioni mm  
Dimensions mm

Ø54 x 90 x 148

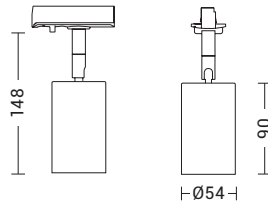

Il design unico, compatto ed essenziale di Manuka è stato studiato appositamente per unire estetica e funzionalità: con un semplice gesto il corpo in alluminio del proiettore arretra scoprendo la lampadina, permettendone una facile, veloce e sicura sostituzione.

The unique, compact and essential design of Manuka has been designed specifically to combine aesthetics and functionality: with a simple gesture the aluminum body of the projector retracts discovering the bulb, allowing an easy, fast and safe replacement.



## Finiture Finishes



**B**



**N**



**GR**

## Altre applicazioni Other applications

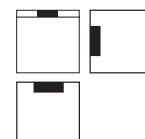

Incasso Recessed  
Parete Wall  
Plafone Ceiling  
p.59

# SQUASH/SQUASH PRO

## MONOFASE MONOPHASE

### AXIOM







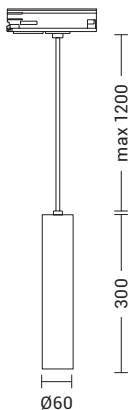

Codice Code	CCT	Flusso lm Flux lm	Potenza W W	Dimensioni mm Dimensions mm
<b>AXI004XX</b>	3000K	1500	15W	Ø60 x 300

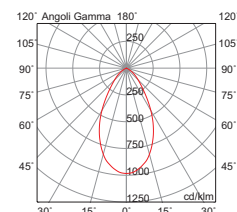

Cavo in trasparente PVC.  
Lunghezza max 1200 mm.

Suspension cable in clear PVC.  
Length max 1200 mm.







Codice Code		Potenza W W	Dimensioni mm Dimensions mm
<b>AXI013XX</b>	GU10	1x50W max	Ø56 x 300

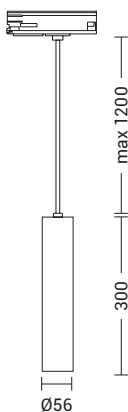

Cavo nero o bianco in tessuto.  
Lunghezza max 1200 mm.

Black or white suspension fabric  
cable. Length max 1200 mm.

#### Finiture Finishes



**B**

**N**

#### Altre applicazioni Other applications



Parete Wall  
 p.64  
 Plafone Ceiling  
 p.65

Restyle

## CORVINA



Codice Code		Potenza Wattage	Dimensioni mm Dimensions mm
<b>COR013XX</b>	GU10	1x50W max	Ø50 x 300

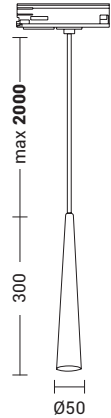

## Finiture Finishes



B



N



OTS

## Altre applicazioni Other applications

Sospensione Suspension  
p.473

## ASIA



Codice Code		Potenza Wattage	Dimensioni mm Dimensions mm
<b>ASI104XX</b>	E14	1x60W max	Ø150 x 200
<b>ASI204XX</b>	E27	1x75W max	Ø225 x 300

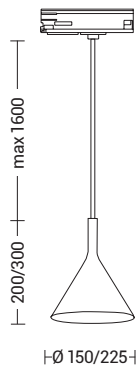

## Finiture Finishes



B



BOS



NB



N

## Altre applicazioni Other applications

Sospensione Suspension  
p.476

# SQUASH/SQUASH PRO

## MONOFASE MONOPHASE

### TELCO



LED
 30°
 CRI≥90
 IP20

Codice Code	CCT	Flusso lm Flux lm	Potenza Wattage	Dimensioni mm Dimensions mm
<b>TEL001XX</b>	3000K-4000K	2300	12W	766 x 35 x 34
<b>TEL002XX</b>	3000K-4000K	4300	24W	1410 x 35 x 34

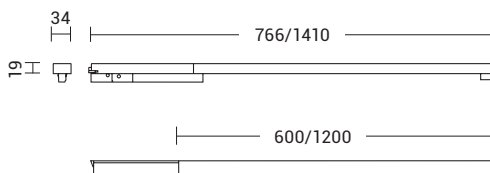

Installato su binario SQUASH PRO va in battura con il profilo: il corpo illuminante rimane nascosto all'interno del binario, con un ridotto impatto visivo.

Installed on track SQUASH PRO, it's in line with the profile: the luminaire remains hidden inside the track, with reduced visual impact.

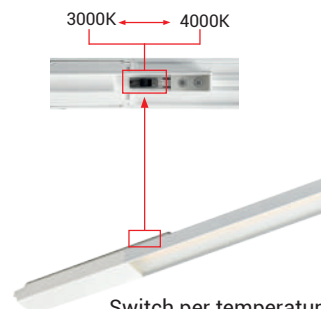

Switch per temperatura colore (3000K - 4000K)

Switch for colour temperature (3000K - 4000K)

Finiture Finishes



B

N

### RABAB



335°

90°

LED
 IP20

Codice Code	GU10	Potenza Wattage	Dimensioni mm Dimensions mm
<b>6036-2-XX</b>	GU10	2x50W max	Ø124 x 156

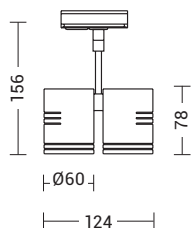

Accessori Accessories



B

N



**6015-XX**

Attacco a parete / plafone  
Wall/ceiling adapter

Restyle