

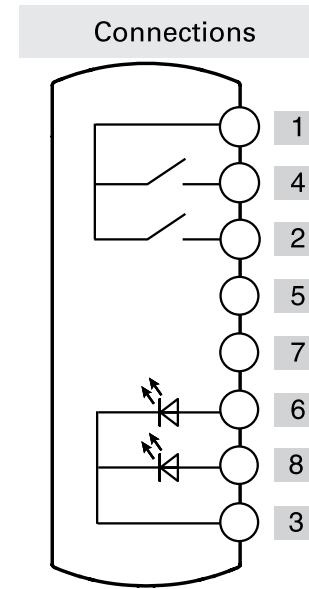

Illuminated  
button  
spring-return

Non-illuminated  
button  
spring-return

	Contacts	Diagram
Device 1	1NO	
Device 2	1NO	



Connector	M12 with 8 pole at the bottom	
-----------	----------------------------------	--

