

BN IO-LINK INTERFACE DESCRIPTION

Version 1.2 26/11/2025

1 COMMUNICATION

Parameter	Value
Vendor ID	1476 (dec.), 0x05C4 (hex.)
Vendor Name	Pizzato Elettrica SRL
Vendor URL	www.pizzato.com
Product Name	BN AC4EA06
Device ID	38 (dec.), 0x000026 (hex.)
IO-Link Revision	v1.1.4
Process Data In Length (bytes)	6
Process Data Out Length (bytes)	4
Bit Rate (bps)	38400 (COM2)
Minimum cycle time (ms)	4.7
Port Class	A
SIO mode	No
Block Parametrization	Yes
Data Storage	Yes
Fw Update	No

2 PROCESS DATA IN

The cyclical parameters that the IO-Link master exchanges with the device are listed in the following table. The button indexes start from the top of the product. The second contact is optional, so its state is visible only in device configurations that support it.

Name	Byte Position	Length	Value
BUTTON 1	0	1 byte	0 = Open contacts; 1 = First contact closed; 2 = Second contact closed; 3 = First and second contacts closed
BUTTON 2	1	1 byte	0 = Open contacts; 1 = First contact closed; 2 = Second contact closed; 3 = First and second contacts closed
BUTTON 3	2	1 byte	0 = Open contacts; 1 = First contact closed; 2 = Second contact closed; 3 = First and second contacts closed
BUTTON 4	3	1 byte	0 = Open contacts; 1 = First contact closed; 2 = Second contact closed; 3 = First and second contacts closed
VOLTAGE	4	2 bytes	Voltage value (mV)

3 PROCESS DATA OUT

The cyclical parameters that the IO-Link master exchanges with the device are listed in the following table. The LED indexes start from the top of the product.

If the device it's a selector, the light colour can be only white.

Name	Byte position	Length	Fields	Field Name	Value
LED 1	0	1 byte	Bit 0-3	Colour	0 = Red; 1 = Green; 2 = Blu; 3 = Yellow; 4 = Cyan; 5 = Magenta; 6 = White; 7 = Custom 1; 8 = Custom 2; 9 = Custom 3; 10 = Custom 4; 11...15 = n/a
			Bit 4-6	Mode	0 = Off; 1 = On; 2 = Flash 0,5 Hz; 3 = Flash 1 Hz; 4 = Flash 2 Hz; 5 = Fade; 6,7 = n/a
			Bit 7	Brightness	0 = Low; 1 = High
LED 2	1	1 byte	Bit 0-3	Colour	0 = Red; 1 = Green; 2 = Blu; 3 = Yellow; 4 = Cyan; 5 = Magenta; 6 = White; 7 = Custom 1; 8 = Custom 2; 9 = Custom 3; 10 = Custom 4; 11...15 = n/a
			Bit 4-6	Mode	0 = Off; 1 = On; 2 = Flash 0,5 Hz; 3 = Flash 1 Hz; 4 = Flash 2 Hz; 5 = Fade; 6,7 = n/a
			Bit 7	Brightness	0 = Low; 1 = High
LED 3	2	1 byte	Bit 0-3	Colour	0 = Red; 1 = Green; 2 = Blu; 3 = Yellow; 4 = Cyan; 5 = Magenta; 6 = White; 7 = Custom 1; 8 = Custom 2; 9 = Custom 3; 10 = Custom 4; 11...15 = n/a
			Bit 4-6	Mode	0 = Off; 1 = On; 2 = Flash 0,5 Hz; 3 = Flash 1 Hz; 4 = Flash 2 Hz; 5 = Fade; 6,7 = n/a
			Bit 7	Brightness	0 = Low; 1 = High

LED 4	3	1 byte	Bit 0-3	Colour	0 = Red; 1 = Green; 2 = Blu; 3 = Yellow; 4 = Cyan; 5 = Magenta; 6 = White; 7 = Custom 1; 8 = Custom 2; 9 = Custom 3; 10 = Custom 4; 11...15 = n/a
			Bit 4-6	Mode	0 = Off; 1 = On; 2= Flash 0,5 Hz; 3 = Flash 1 Hz; 4 = Flash 2 Hz; 5 = Fade; 6,7 = n/a
			Bit 7	Brightness	0 = Low; 1 = High

Legend: n/a = not available

4 PROCESS DATA OVERVIEW

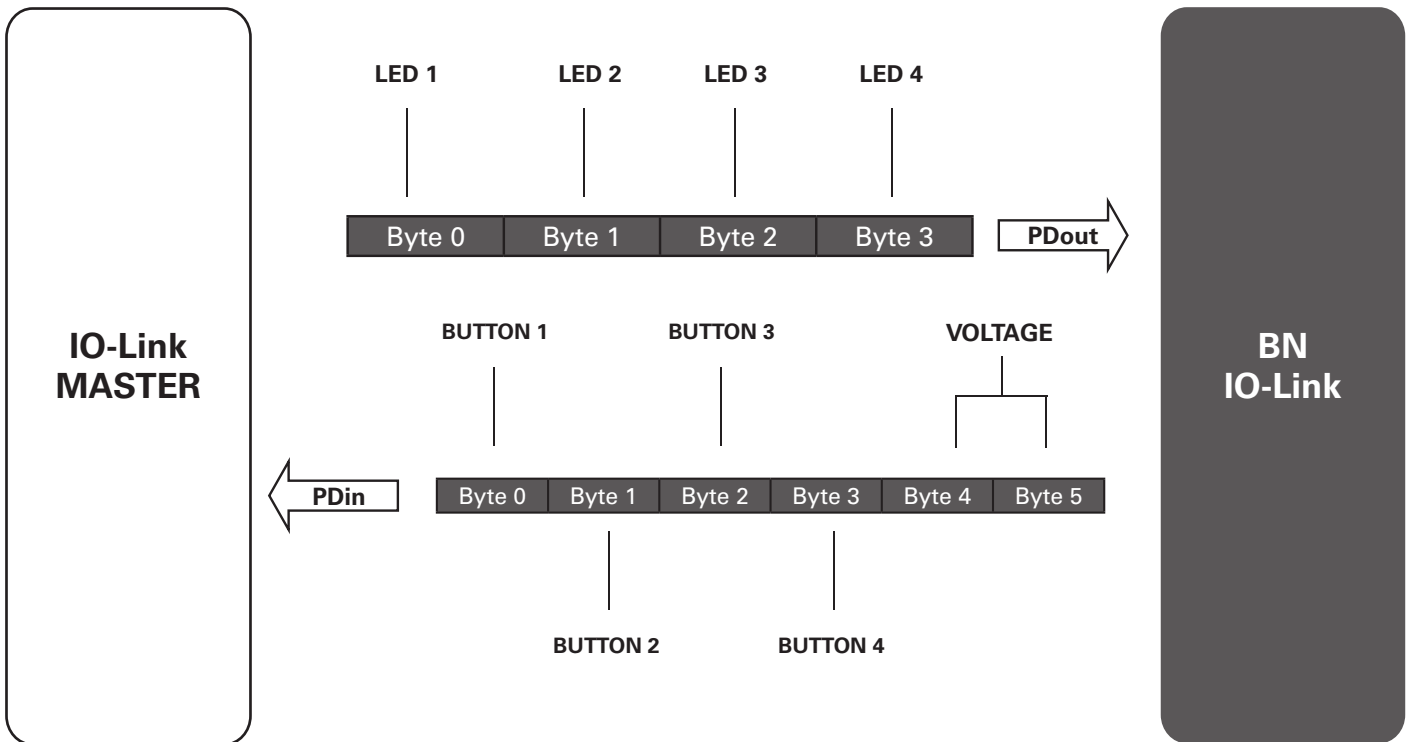

5 PARAMETERS OVERVIEW

The following parameters can be read from and/or written to a Device with a IO-Link master.

Name	Index	Sub-index	Data type	Read/Write	Data Storage	Default Value
SystemCommand	2	0	UIntegerT (8 bit)	WO		
VendorName	16	0	StringT (64 bytes)	RO		"Pizzato Elettrica SRL"
VendorText	17	0	StringT (64 bytes)	RO		"PASSION FOR QUALITY"
ProductName	18	0	StringT (64 bytes)	RO		"BN"
ProductID	19	0	StringT (64 bytes)	RO		"BN ACxEAx"
ProductText	20	0	StringT (64 bytes)	RO		"BN IO-Link"
SerialNumber	21	0	StringT (16 bytes)	RO		"****"
HardwareRevision	22	0	StringT (10 bytes)	RO		
FirmwareRevision	23	0	StringT (64 bytes)	RO		
Application-specific Tag	24	0	StringT (32 bytes)	RW	✓	"****"
Function Tag	25	0	StringT (32 bytes)	RW	✓	"****"
Location Tag	26	0	StringT (32 bytes)	RW	✓	"****"

Error Count	32	0	UIntegerT (16 bit)	RO		
Device Status	36	0	UIntegerT (8 bit)	RO		
Detailed Device Status	37	0	ArrayT (3 bytes) [4]	RO		
Process Data IN	40	0	RecordT (6 bytes)	RO		
Process Data OUT	41	0	RecordT (4 bytes)	RO		
Custom Colour1	64	1 - Red	UIntegerT (8 bit)	RW	✓	128
		2 - Green	UIntegerT (8 bit)	RW	✓	128
		3 - Blue	UIntegerT (8 bit)	RW	✓	128
Custom Colour2	65	1 - Red	UIntegerT (8 bit)	RW	✓	128
		2 - Green	UIntegerT (8 bit)	RW	✓	128
		3 - Blue	UIntegerT (8 bit)	RW	✓	128
Custom Colour3	66	1 - Red	UIntegerT (8 bit)	RW	✓	128
		2 - Green	UIntegerT (8 bit)	RW	✓	128
		3 - Blue	UIntegerT (8 bit)	RW	✓	128
Custom Colour4	67	1 - Red	UIntegerT (8 bit)	RW	✓	128
		2 - Green	UIntegerT (8 bit)	RW	✓	128
		3 - Blue	UIntegerT (8 bit)	RW	✓	128
OperatingHours	80	0	UIntegerT (32 bit)	RO		
Temperature	81	0	IntegerT (16 bit)	RO		

Legend: RO = read only WO = write only RW = read/write

6 PARAMETERS

The following parameters can be chosen by the customer and they are included inside the Data Storage. For custom colours, FADE mode is not available.

Name	Length	Fields	Field Name	Value
CUSTOM COLOUR 1	3 bytes	Byte 0	Red	0-255 (dec.) PWM value
		Byte 1	Green	0-255 (dec.) PWM value
		Byte 2	Blue	0-255 (dec.) PWM value
CUSTOM COLOUR 2	3 bytes	Byte 0	Red	0-255 (dec.) PWM value
		Byte 1	Green	0-255 (dec.) PWM value
		Byte 2	Blue	0-255 (dec.) PWM value
CUSTOM COLOUR 3	3 bytes	Byte 0	Red	0-255 (dec.) PWM value
		Byte 1	Green	0-255 (dec.) PWM value
		Byte 2	Blue	0-255 (dec.) PWM value
CUSTOM COLOUR 4	3 bytes	Byte 0	Red	0-255 (dec.) PWM value
		Byte 1	Green	0-255 (dec.) PWM value
		Byte 2	Blue	0-255 (dec.) PWM value

7 DIAGNOSIS PARAMETERS

The following parameters can only be read from Device.

Name	Length	Fields	Value
OPERATING HOURS	4 bytes	Byte 0-3	Number of operating hours
TEMPERATURE	2 bytes	Byte 0-1	Current temperature value

Name	Index	Sub-Index	Value
DEVICE STATUS	36	0	0 = Device is OK; 1 = Maintenance required; 2 = Out of specification; 3 = Functional check; 4 = Failure
DETAILED DEVICE STATUS Detailed Device Status[1] Detailed Device Status[2] Detailed Device Status[3] Detailed Device Status[4]	37	0	Per ArrayT element Byte 1 = EventQualifier Bytes 2,3 = EventCode Dynamic list is implemented to get all current errors (up to 4)
ERROR COUNT	32	0	Counts all occurred error events since the power-on process

8 COMMANDS

The following functions are related to the System Command at Index 2 (described in the Parameter overview table).

Command Code	Name	Section	Description
129 (dec.)	Application Reset	Service Function	Reset variables inside the Data Storage to the default value
131 (dec.)	BackToBox	Service Function	Reset variables inside the Data Storage to the default value. The device will lose communication with the IO-Link master. The device must be restarted.

9 EVENTS

Events are acyclic transmissions from the IO-Link device to report a problem to the IO-Link master.

Code	Device Status value	Name	Description
6202 (dec.)	4 (dec.)	Internal Fault 1	Contact Pizzato Elettrica assistance
6203 (dec.)	4 (dec.)	Internal communication error	Reset Device
6204 (dec.)	4 (dec.)	Internal IO-Link transceiver error	Reset Device
6205 (dec.)	2 (dec.)	Process Data error	Written Process Data Out value out of range. Check datasheet and values
16912 (dec.)	2 (dec.)	Device temperature overrun	Clear source of heat
16928 (dec.)	2 (dec.)	Device temperature underrun	Insulate Device

20752 (dec.)	2 (dec.)	Primary supply voltage overrun	Check tolerance
20753 (dec.)	2 (dec.)	Primary supply voltage underrun	Check tolerance
35840 (dec.)	4 (dec.)	Technology specific application fault	Reset Device

10 SUPPORT

The device may be used for safety applications, therefore in case of any doubt concerning installation or operation methods, always contact our technical support service:

Pizzato Elettrica Srl
 Via Torino, 1 - 36063 Marostica (VI) - ITALY
 Telephone +39.0424.470.930
 E-mail tech@pizzato.com
 www.pizzato.com

Our support service provides assistance in Italian and English.

DISCLAIMER:

Subject to modifications without prior notice and errors excepted. The data given in this sheet are accurately checked and refer to typical mass production values. The device descriptions and its applications, the fields of application, the external control details, as well as information on installation and operation, are provided to the best of our knowledge. This does not in any way mean that the characteristics described may entail legal liabilities extending beyond the "General Terms of Sale", as stated in the Pizzato Elettrica general catalogue. Customers/users are not absolved from the obligation to read and understand our information and recommendations and pertinent technical standards, before using the products for their own purposes. Taking into account the great variety of applications and possible connections of the device, the examples and diagrams given in the present manual are to be considered as merely descriptive; the user is deemed responsible for checking that the specific application of the device complies with current standards. This document is a translation of the original instructions. In case of discrepancy between the present sheet and the original copy, the Italian version shall prevail. All rights to the contents of this publication are reserved in accordance with current legislation on the protection of intellectual property. The reproduction, publication, distribution and modification, total or partial, of all or part of the original material contained therein (including, but not limited to, texts, images, graphics), whether on paper or in electronic form, are expressly prohibited without written permission from Pizzato Elettrica Srl.

All rights reserved. © 2025 Copyright Pizzato Elettrica