

Contact-Type Smart Sensor E9NC-T

Advanced, Durable, Space-saving Contact Sensors.



- OMRON's unique ball spline mechanism for resistance to vibration and shock.
- Employs a robot cable that withstands bending. *1
- Slim, short Sensor Heads and slim Amplifier Units to save you space.
- A flanged type that does not require mounting brackets and is easy to replace.
- Transmits high-precision data with a resolution of 0.1 μm across a network (E9NC-TA0 only).

*1. Robot cable specifications apply to the Sensor Head cable and the Connection Cable between the Preamplifier and the Amplifier Unit.



For the most recent information on models that have been certified for safety standards, refer to your OMRON website.

Refer to Safety Precautions on page 8.

Features

Handles Diverse Measurement Applications

■ Handles Measurement Applications in Harsh Environments

Durable

Tough under Vibration and Shock

Ball Spline Mechanism

Cross-sectional Area

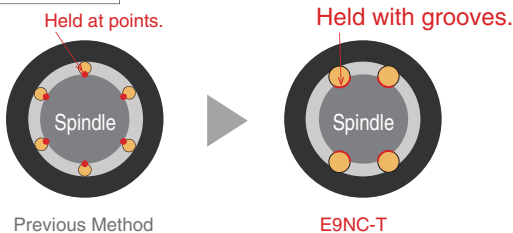

■ Handles Measurement Applications with Limited Space

Space-saving

Slim, Short Sensor Heads

8-mm outside diameter

Slim Amplifier Units

Slim Body Only 10 mm Wide

Save more space and design more freely with the right-angle air type.



■ Handles Advanced Measurement Applications*2

Advanced

Data Communications via Field Networks

High-precision Data Transmission (0.1-μm Resolution)

Connect Many Sensors

Connect Up to 30 Sensors with Reduced Wiring*3

Eight Calculation Functions*4

Maximum Value, Minimum Value, Flatness, Average, Step, Twist, Warp, and Thickness

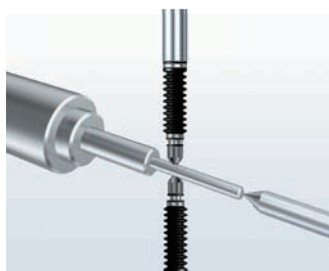

Measurement of Machined Part Precision

*2. E9NC-TA0 only.

*3. You can connect up to 30 Sensors to an E3NW Sensor Communications Unit with EtherCAT (when an OMRON NJ-series Controller is used) or up to 16 Sensors with CC-Link.







*4. Calculations are performed on the host controller. Special function blocks are available separately. For details, please contact your OMRON sales representative.

E9NC-TH5S (on the left) and E9NC-TH5L (on the right)



E9NC-T

Ordering Information

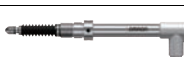
Sensor Heads (Dimensions → page 10 and 11) (Connection Cable between Pre-amplifier and Amplifier Unit is not provided with the Sensor Head. Be sure to have the Connection Cable ready when using the Sensor.)

Type	Appearance	Measuring range (Moving range)	Resolution	Model
Straight type		5 mm	0.1 μm	E9NC-TH5S 2M
Right-angle air type				E9NC-TH5L 2M
Flanged type/ Straight type				E9NC-TH5SF 2M
Flanged type/ Right-angle air type				E9NC-TH5LF 2M
Straight type		12 mm		E9NC-TH12S 2M
Right-angle air type				E9NC-TH12L 2M
Flanged type/ Straight type				E9NC-TH12SF 2M
Flanged type/ Right-angle air type				E9NC-TH12LF 2M

Amplifier Units (Dimensions → page 12)

Type	Appearance	Model	
Communications*		E9NC-TA0	
ON/OFF output		NPN output	PNP output
		E9NC-TA21 2M	E9NC-TA51 2M

* A Sensor Communications Unit is required if you want to use the Amplifier Unit on a network.

Connection Cable between Pre-amplifier and Amplifier Unit (Dimensions → page 13)



Cable length	Model	Quantity
0.5 m	E9NC-TXC05	1
5 m	E9NC-TXC5	1
10 m	E9NC-TXC10	1
20 m	E9NC-TXC20	1

Accessories (Sold Separately)

Sensor Head Accessories

Probe (Dimensions → page 13)

The E9NC-TB1 is provided with the Sensor Head. Order replacements as required.

Type	Appearance	Model	Quantity
3-dia. probe		E9NC-TB1	1
Nylon probe		E9NC-TB2	1
Probe for flat surfaces		E9NC-TB3	1

Rubber boots (Dimensions → page 13)

A rubber boot is provided with the Sensor Head. Order replacements as required.

Applicable Sensor Head	Model	Quantity
E9NC-TH5□	E9NC-G5	1
E9NC-TH12□	E9NC-G12	1

Amplifier Unit Accessories

Amplifier Unit Mounting Bracket (Dimensions → page 14)

A Mounting Bracket is not provided with the Amplifier Unit. It must be ordered separately as required.

Appearance	Model	Quantity
	E39-L143	1

DIN Track (Dimensions → page 14)

A DIN Track is not provided with the Amplifier Unit. It must be ordered separately as required.

Appearance	Type	Model	Quantity
	Shallow type, total length: 1 m	PFP-100N	1
	Shallow type, total length: 0.5 m	PFP-50N	1
	Deep type, total length: 1 m	PFP-100N2	1

End Plate (Dimensions → page 14)

An End Plate is not provided with the Amplifier Unit. It must be ordered separately as required.

Appearance	Model	Quantity
	PFP-M	1

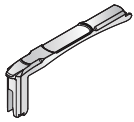

Cover

Attach these Covers to Amplifier Units. Order a Cover when required, e.g., if you lose the covers.

Appearance	Model	Quantity
	E39-G22 FOR E9NC-TA	1

Related Products

Sensor Communications Units

Type	Appearance	Model
Sensor Communications Unit for EtherCAT		E3NW-ECT
Sensor Communications Unit for CC-Link		E3NW-CCL
Distributed Sensor Unit*		E3NW-DS

Refer to your OMRON website for details.

The E9NC-TA0 is supported for firmware version 1.03 or higher (Sensor Communications Units manufactured in July 2014 or later).

*The Distributed Sensor Unit can be connected to any of the Sensor Communications Units.

EtherCAT® is a registered trademark and patented technology, licensed by Beckhoff Automation GmbH, Germany.

CC-Link is a registered trademark of Mitsubishi Electric Corporation. The trademark is managed by the CC-Link Partner Association.

E9NC-T

Ratings and Specifications

Sensor Heads

Type	Straight type		E9NC-TH5S	E9NC-TH12S
Item	Right-angle air type		E9NC-TH5L	E9NC-TH12L
	Flanged type/Straight type		E9NC-TH5SF	E9NC-TH12SF
	Flanged type/Right-angle air type		E9NC-TH5LF	E9NC-TH12LF
	Measuring range (Moving range)		5 mm	12 mm
Resolution		0.1 μm		
Precision *1		1 μm		
Measuring force *1	Upward		0.35±0.25 N	0.4±0.3 N
	Horizontal		0.4±0.25 N	0.5±0.3 N
	Downward		0.45±0.25 N	0.6±0.3 N
Indicator (Preamplifier)		Operation indicator (blue/red)		
Ambient temperature range		Operating: -10 to 55°C; Storage: -20 to 60°C (with no icing or condensation)		
Ambient humidity range		Operating and storage: 35% to 85% (with no condensation)		
Maximum response speed		80 m/min		
Origin detection speed		80 m/min		
Origin position		1 ±0.5 mm from the spindle push-out position (the lowest point)		
Vibration resistance (destruction)		100 m/s ² (20 to 2,000 Hz) 20 minutes each in X, Y, and Z directions		
Shock resistance (destruction)		1,000 m/s ² 3 times each in X, Y, and Z directions		
Degree of protection	Head	Right-angle air type	IEC IP67 (only when a hose elbow and air hose are connected)	
		Straight type	---	
	Preamplifier		---	
Number of sliding operations		92 million times (based on OMRON's dedicated evaluation)		
Probe		Carbide with a round surface, screw thread size: M2.5		
Connecting method		Pre-wired connector (2 m from the Sensor Head to the Preamplifier)		
Materials	Sensor Head		Stainless steel (SUS303)	
	Rubber boot		Nitrile rubber (NBR)	
	Preamplifier		ABS	
	Probe contact point *2		Carbide	
	Cable		PVC	
	Hose elbow for air (included) (Right-angle air type only)		Nickel-plated brass	
	Tightening nut, Wave washer (Flanged type only)		Tightening nut: Stainless steel (SUS410), Wave washer: SK5	
Weight (packed state/Sensor Head only)		Approx. 340 g/approx. 110 g		
Accessories		Common: Wrench, Instruction Manual Right-angle air type: Hose elbow Flanged type: Tightening nut, wave washer, clamp wrench, pin		

*1. These values were measured at an ambient temperature of 20°C.

*2. For the case of the provided E9NC-TB1 (3-dia. probe)

Amplifier Units

		Type	Communications	ON/OFF output
Item		NPN output	E9NC-TA0	E9NC-TA21
		PNP output		E9NC-TA51
		Connecting method	Connector for Sensor Communications Unit	Pre-wired type
Inputs/ outputs	Outputs	---*1		2 outputs
	External inputs			1 input
Power supply voltage		Supplied from the connector through the Sensor Communications Unit		10 to 30 VDC, including 10% ripple (p-p)
Display resolution		0.1 μm min.		
Power consumption *2		At Power Supply Voltage of 24 VDC Normal mode: 2,040 mW max. (Current consumption: 85 mA max.) Eco ON: 1,800 mW max. (Current consumption: 75 mA max.) Eco LO: 1,920 mW max. (Current consumption: 80 mA max.)		
Control outputs *3		---		Load power supply voltage: 30 VDC max., open-collector output Load current: 100 mA max. in total for the 2 outputs (Residual voltage At load current of less than 10 mA: 1 V max., at load current of 10 to 100 mA: 2 V max.) OFF current: 0.1 mA max.
External inputs		---		Refer to *4.
Indicators		7-segment displays (white) GO indicator (orange), HIGH/LOW indicator (orange), NO/NC indicator (orange), PRST indicator (green), ST indicator (blue)		
Protection circuits		Power supply reverse polarity protection and output short-circuit protection		Power supply reverse polarity protection, output short-circuit protection, and output reverse polarity protection
Response time	Super-high-speed mode (SHS)	Operate or reset: 3 ms		
	High-speed mode (HS)	Operate or reset: 10 ms		
	Standard mode (Std)	Operate or reset: 100 ms		
	Giga mode (GIGA)	Operate or reset: 1,000 ms		
Threshold setting		Smart Tuning (2-point area tuning, tolerance tuning, 2-point tuning, 1-point tuning), or manual adjustment		
No. of banks		4		
Functions	Output mode selection	Normal output, hybrid output (Output is performed according to the combination of the two bits used to specify HIGH, GO, LOW, and error.)		
	Preset	Negative values can be displayed.		
	Resetting settings *5	Select from initial reset (factory defaults) or user reset (saved settings).		
	Eco mode *6	Select from OFF (digital display lit), ECO ON (digital display not lit), and ECO LO (digital display dimmed).		
	Bank switching	Select from banks 1 to 4.		
	Origin point use setting	Select whether using the Sensor Head origin point or setting the point at power ON as origin.		
	Direction	Switchable		
	Output	Select from Normal sensing mode or Area sensing mode.		
	External input	---	Select from preset, bank switching, input OFF, and tuning.	
Display digits	Settable in units ranging from 0.0001 mm to 1 mm.			
Hysteresis width	---	Select from standard setting or user setting. The hysteresis width can be set to a value from 0 to 9999.9999 in the user settings.		
Maximum connectable Units		With E3NW-ECT: 30 units *7 With E3NW-CCL: 16 units		30 units
Ambient temperature range		Operating: Groups of 1 or 2 Amplifier Units: 0 to 55°C, Groups of 3 to 10 Amplifier Units: 0 to 50°C, Groups of 11 to 16 Amplifier Units: 0 to 45°C, Groups of 17 to 30 Amplifier Units: 0 to 40°C Storage: -30 to 70°C (with no icing or condensation)		Operating: Groups of 1 or 2 Amplifier Units: -25 to 55°C, Groups of 3 to 10 Amplifier Units: -25 to 50°C, Groups of 11 to 16 Amplifier Units: -25 to 45°C, Groups of 17 to 30 Amplifier Units: -25 to 40°C Storage: -30 to 70°C (with no icing or condensation)
Ambient humidity range		Operating and storage: 35% to 85% (with no condensation)		
Insulation resistance		20 MΩ (at 500 VDC)		
Dielectric strength		1,000 VAC at 50/60 Hz for 1 minute		
Vibration resistance (destruction)		10 to 55 Hz with a 1.5-mm double amplitude for 2 hours each in X, Y, and Z directions		
Shock resistance (destruction)		150 m/s ² for 3 times each in X, Y, and Z directions		500 m/s ² for 3 times each in X, Y, and Z directions
Weight (packed state/Amplifier Unit only)		Approx. 65 g/approx. 25 g		Approx. 115 g/approx. 75 g
Materials	Case	Polycarbonate (PC)		
	Cover	Polycarbonate (PC)		
	Cable	---	PVC	
Accessories		Instruction Manual		

*1. Two sensor outputs are allocated in the programmable logic controller (PLC) I/O table.
PLC operation via Communications Unit enables reading detected values and changing settings.

*2. At Power Supply Voltage of 10 to 30 VDC.
Normal mode: 2,250 mW max. (Current consumption: 75 mA max. at 30 VDC, 155 mA max. at 10 VDC)
Eco ON: 2,010 mW max. (Current consumption: 67 mA max. at 30 VDC, 135 mA max. at 10 VDC)
Eco LO: 2,130 mW max. (Current consumption: 71 mA max. at 30 VDC, 145 mA max. at 10 VDC)

*3. Load current: 20 mA max. in total for the 2 outputs when 4 or more units are linked.

E9NC-T

*4. The following details apply to the input.

	Contact input (relay or switch)	Non-contact input (transistor)	Input time*4-1
NPN	ON: Shorted to 0 V (Sourcing current: 1 mA max.). OFF: Open or shorted to Vcc.	ON: 1.5 V max. (Sourcing current: 1 mA max.) OFF: Vcc – 1.5 V to Vcc (Leakage current: 0.1 mA max.)	ON: 9 ms min. OFF: 20 ms min.
PNP	ON: Shorted to Vcc (Sinking current: 3 mA max.). OFF: Open or shorted to 0 V.	ON: Vcc – 1.5 V to Vcc (Sinking current: 3 mA max.) OFF: 1.5 V max. (Leakage current: 0.1 mA max.)	

*4-1. Input time is 25 ms (ON)/(OFF) only when (in tUnE) input is selected.

*5. The bank is not reset by the user reset function or saved by the user save function.

*6. ECO LO is supported for Amplifier Units manufactured in August 2014 or later.

*7. When the Sensors are connected to an OMRON NJ-series Controller.

I/O Circuit Diagrams

Output method	Model	Operation mode	Timing chart	NO/NC indicator	Output circuit
NPN	E9NC-TA21	NO		NO lit.	
		NC		NC lit.	
PNP	E9NC-TA51	NO		NO lit.	
		NC		NC lit.	

Signal Assignments to the Output Wire

When normal output mode and NO operation are set

	GO judgment	NoGO judgment	Error judgment or Undetermined
Control output 1	ON	OFF	OFF
Control output 2	OFF		ON

When hybrid output mode and NO operation are set

	LOW judgment	GO judgment	HIGH judgment	Error judgment or Undetermined
Control output 1	OFF	ON	ON	OFF
Control output 2	ON	ON	OFF	OFF

- Note:**
- The output is reversed when the operation mode is set to NC. The indicator is not reversed.
 - If the judgment output mode is the normal sensing mode, the output is provided in the normal output pattern regardless of the setting.
 - The change timing of the control output 1 and the control output 2 shifts for 10 μm at the maximum.

Nomenclature

E9NC-TA0/TA21/TA51

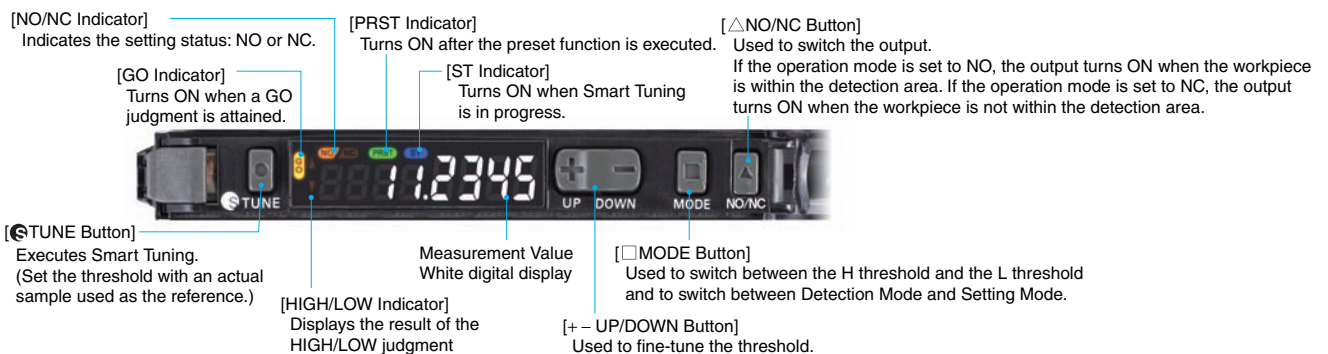

E9NC-T

Safety Precautions

Be sure to read the precautions for E9NC-T in the website at: <http://www.ia.omron.com/>.

Sensor Heads

WARNING

Do not forcibly bend or pull the cables.
Do not put a heavy object on them or heat them.
Doing so may damage the cables, resulting in a fire.



Do not disassemble or alter the unit. There is a risk of injury or electric shock. And it may cause damage on the internal circuit.



Precautions for Safe Use

Please observe the following precautions for safe use of the products.

1. Installation Environment

- Do not use the product in environments where it can be exposed to inflammable/explosive gas.
- To secure the safety of operation and maintenance, do not install the product close to high-voltage devices or power devices.

2. Power Supply and Wiring

- Be sure to use an E9NC-TA□□ Amplifier Unit. Connecting to other amplifier unit may cause damage or fire.
- When shortening cables, be sure to connect wires according to the specifications. Misconnection may cause damage or fire.
- High-voltage lines and power lines must be wired separately from this product. Wiring them together or placing them in the same duct may cause induction, resulting in malfunction or damage.
- Always turn OFF the power of the unit before connecting or disconnecting the connectors.
- To prevent cables to cut, fix it in a place where too much tension should not be applied to it. Avoid pulling cables too strongly or bending them too much.
Repeated flexing: R50 or more
Permanent bend: R20 or more
- Head and output cables must be placed separately from the power line.

3. Installation

- Use the dedicated wrench that comes with the product for attaching and detaching the probe. Do not apply torque of 0.1 N·m or more to the spindle. Otherwise damage may result. To prevent the probe from coming loose, use the accessory wave washer of nominal 2.5 or use screw lock.
- After you secure the stem, do not apply rotational force. Doing so may result in malfunction.
- Use screws or tightening nut for mounting and be sure to tighten screws with a specified torque.
Specified torque M3 screw: 0.6 N·m
Tightening nut: 1.0 N·m

4. Others

- Do not attempt to disassemble, deform by pressure, incinerate, repair, or modify this product.
- When disposing of the product, treat as industrial waste.
- If you notice an abnormal condition such as a strange odor, extreme heating of the unit, or smoke, immediately stop using the product, turn off the power, and consult your dealer.

Precautions for Correct Use

Please observe the following precautions to prevent failure to operate, malfunctions, or undesirable effects on product performance.

1. Installation Environment

Do not install the product in locations subjected to the following conditions:

- Surrounding air temperature outside the rating
- Rapid temperature fluctuations (causing condensation)
- Relative humidity outside the range of 35 to 85%
- Presence of corrosive or flammable gases
- Presence of dust, salt, or iron particles
- Direct vibration or shock
- Water, oil, or chemical fumes or spray, or mist atmospheres
- Presence of intense magnetic, electric field or high frequency electric field (use the product in a place distant from a noise source such as high power relay and high-voltage high-current switch by 0.5 m or more)

2. Warming Up

- The circuitry is not stable immediately after turning the power ON, and the values gradually change until the Sensor Head is completely warmed up.
- Before using the product, check that its functionality and capability are normal.

3. Maintenance and Inspection

- Always turn off the power of the unit before connecting or disconnecting cables.
- Do not use thinner, alcohol, benzene, acetone, or kerosene to clean the sensor.
- If oil that becomes extremely viscous when it's dry, such as cutting oil, attaches to the rubber boot, the operation may not work properly.
Wipe off with a waste cloth dampened with absolute alcohol.
- The rubber boot may be significantly degraded by organic solvent or ozone in the air or ultraviolet rays in the environment. In such cases, replace the rubber boot regularly (6 months to a year).
- Rubber boots are coated with grease. Please do not remove the grease when the rubber boot is used, since sliding movement may be degraded if it is removed.
- When it used after wiping off the oil, perform regular maintenance not to rust. Be sure to check that there is no influence on the measurement due to the oil when it is used with the oil.

4. Do not use this product under water, rain or outdoors.

■ Using with air supply

(E9NC-TH5L/E9NC-TH5LF/E9NC-TH12L/E9NC-TH12LF)

- The suction air must be dry air with a negative pressure of 0.04 to 0.067 MPa.
- The outside diameter of the tube for air suction inlet must be 4 mm.
- Air suction draws the spindle in.
- If the spindle extrusion rate is high, the amplifier indication may display an error when a workpiece is contacted.
- Too much impact may shift the ball retainer inside the bearing, resulting in less operating range. If so, adjust the spindle rate.
- Attach the hose elbow to the sensor head before you secure it. When you attach the hose elbow, hold the right-angle bracket on the sensor head. Do not apply force to any other part.

Amplifier Units

⚠ WARNING

This product is not designed or rated for ensuring safety of persons either directly or indirectly. Do not use it for such purposes.



Do not use the product with voltage in excess of the rated voltage.

Excess voltage may result in malfunction or fire.



Never use the product with an AC power supply. Otherwise, explosion may result.



Precautions for Safe Use

The following precautions must be observed to ensure safe operation of the product. Doing so may cause damage or fire.

- Do not install the product in the following locations.
 - Locations subject to direct sunlight
 - Locations subject to condensation due to high humidity
 - Locations subject to corrosive gas
 - Locations subject to vibration or mechanical shocks exceeding the rated values
 - Locations subject to exposure to water, oil, chemicals
 - Locations subject to stream
 - Locations subject to strong magnetic field or electric field
- Do not use the product in environments subject to flammable or explosive gases.
- Do not use the product in any atmosphere or environment that exceeds the ratings.
- To secure the safety of operation and maintenance, do not install the product close to high-voltage devices and power devices.
- High-voltage lines and power lines must be wired separately from the product. Wiring them together or placing them in the same duct may cause induction, resulting in malfunction or damage.
- Do not apply any load exceeding the ratings. Otherwise, damage or fire may result.
- Do not short the load. Otherwise, damage or fire may result.
- Connect the load correctly.
- Do not miswire such as the polarity of the power supply.
- To use this device as connecting with each other, be sure to connect with the same power supply and turn ON the power simultaneously. Using a separate power supply will influence the functions when connecting the devices to use them.
- Do not use the product if the case is damaged.
- Burn injury may occur. The product surface temperature rises depending on application conditions, such as the ambient temperature and the power supply voltage. Attention must be paid during operation or cleaning.
- When setting the sensor, be sure to check safety such as by stopping the equipment.
- Be sure to turn off the power supply before connecting or disconnecting wires.
- Do not attempt to disassemble, repair, or modify the product in any way.
- When disposing of the product, treat it as industrial waste.
- Do not use the Sensor in water, rainfall, or outdoors.

Precautions for Correct Use

- Be sure to mount the unit to the DIN track until it clicks.
- When using the Amplifier Units with Connectors for Communications Units, attach the protective caps (provided with E3NW-series Sensor Communications Unit) on the unused power pins to prevent electrical shock and short circuiting.

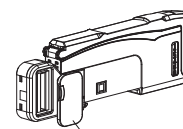

Protective cap

- Do not apply excessive force such as tension, compression or torsion to the connector of the Sensor Head that is fixed to the Amplifier Unit.
- Always keep the protective cover in place when using the Amplifier Unit. Not doing so may cause malfunction.
- It may take time until the measured value become stable immediately after the power is turned on depending on use environment.
- The Mobile Console E3X-MC11, E3X-MC11-SV2 and E3X-MC11-S cannot be connected.
- The E3X-DRT21-S, E3X-CRT, E3X-ECT, and E3NW Sensor Communications Units cannot be used with the models with ON/OFF outputs. The E3NW-ECT or E3NW-CCL Sensor Communications Unit can be used with the model with communications (E9NC-TA0), but the E3X-DRT21-S, E3X-CRT, E3X-ECT, and E3NW-CRT Sensor Communications Units cannot be used.
- If you notice an abnormal condition such as a strange odor, extreme heating of the unit, or smoke, immediately stop using the product, turn off the power, and consult your dealer.
- Do not use thinner, benzene, acetone, and lamp oil for cleaning.

E9NC-T

Dimensions

(Unit: mm)

Tolerance class IT16 applies to dimensions in this data sheet unless otherwise specified.

Sensor Heads

E9NC-TH5S

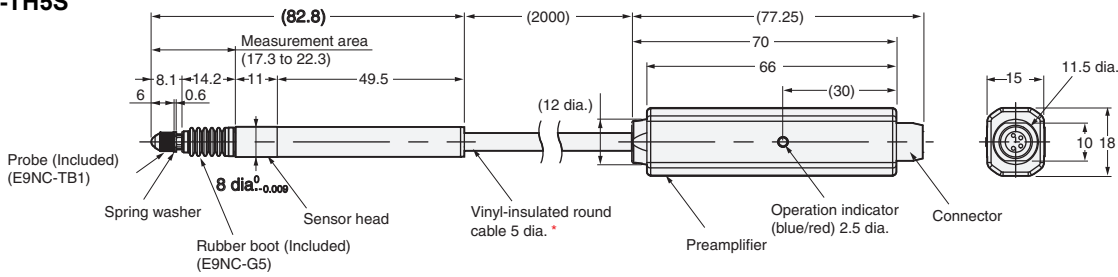

E9NC-TH5L

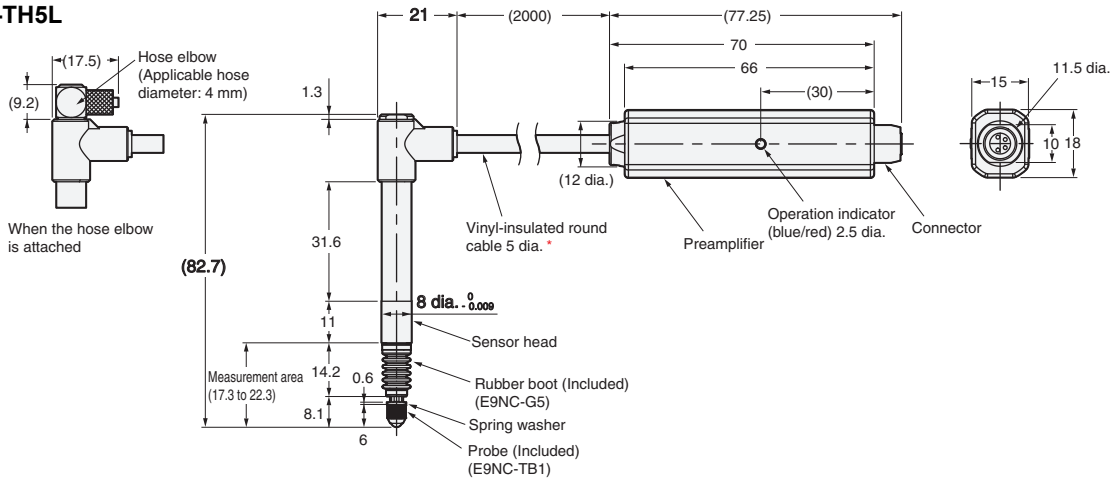

E9NC-TH5SF

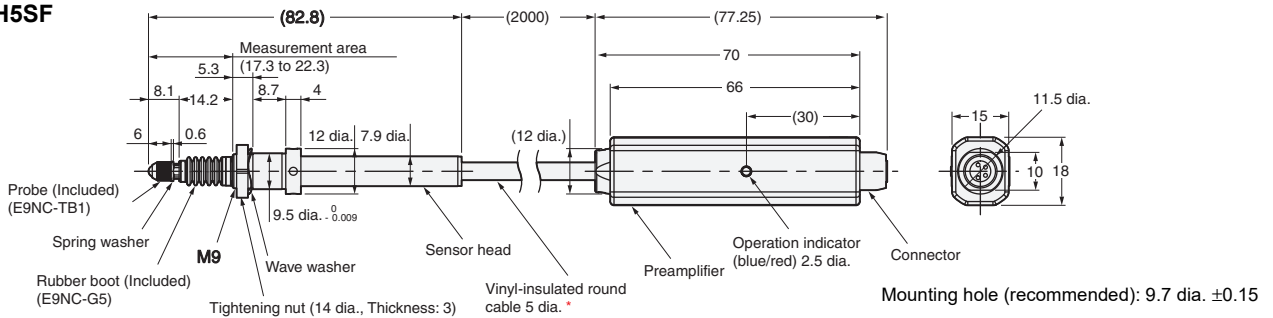

E9NC-TH5LF

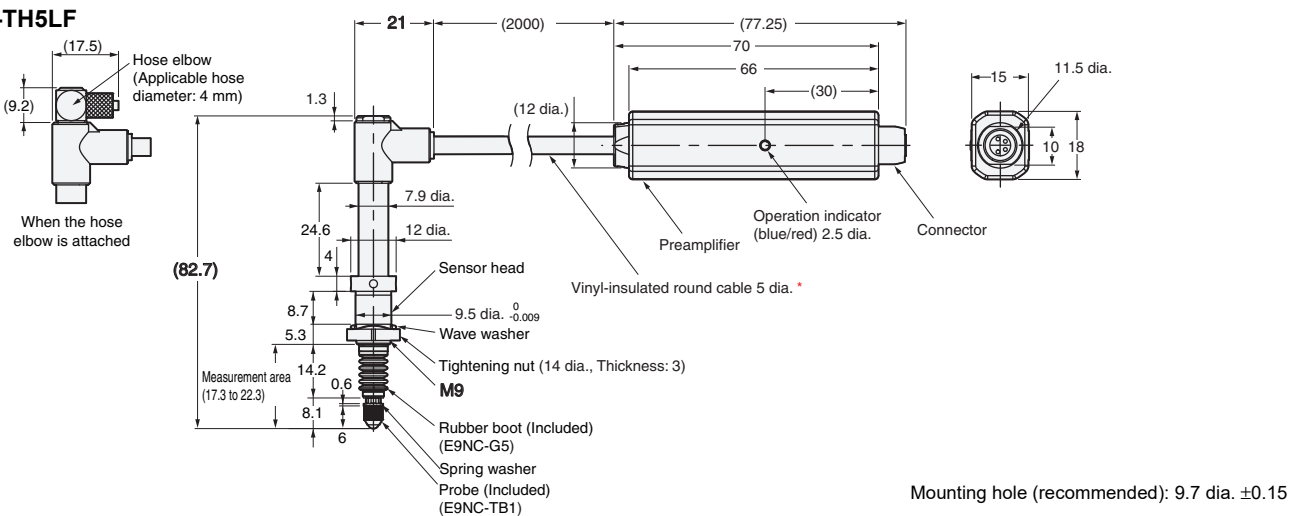

* The minimum bending radiuses of the Sensor Head cable are shown below.
 Repeated flexing: 50 mm
 Permanent bend: 20 mm

E9NC-TH12S

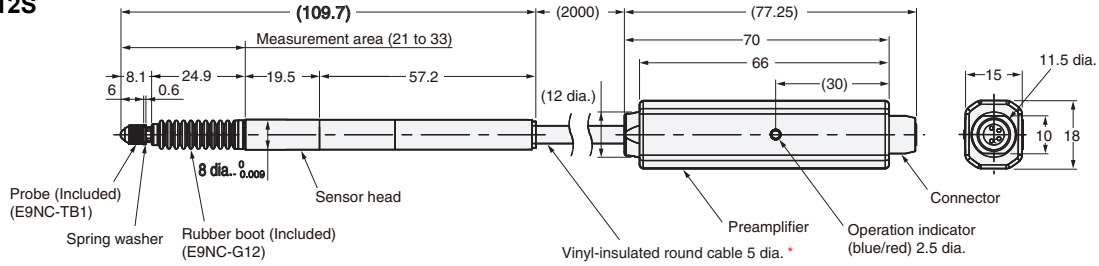

E9NC-TH12L

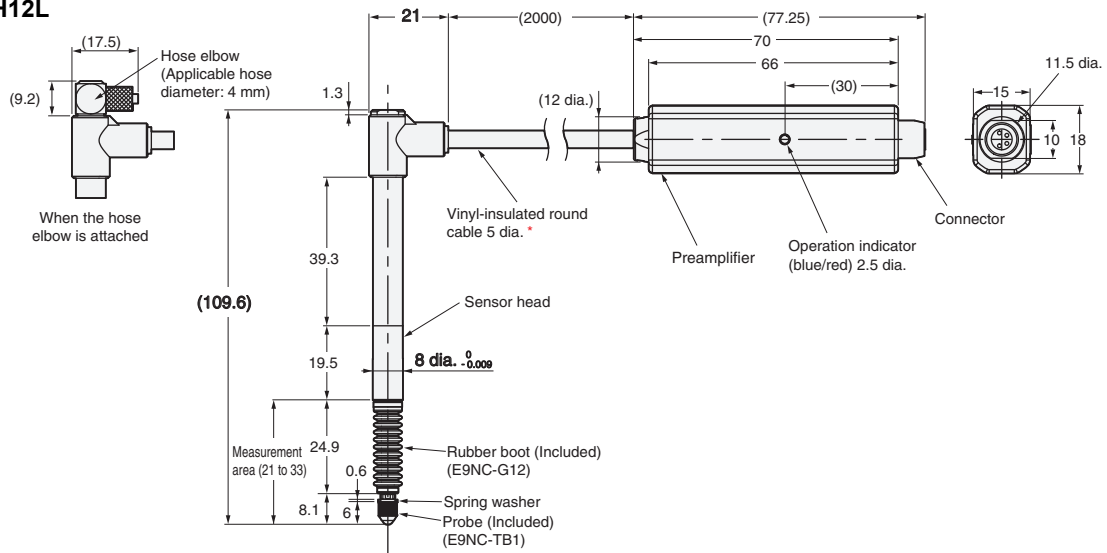

E9NC-TH12SF

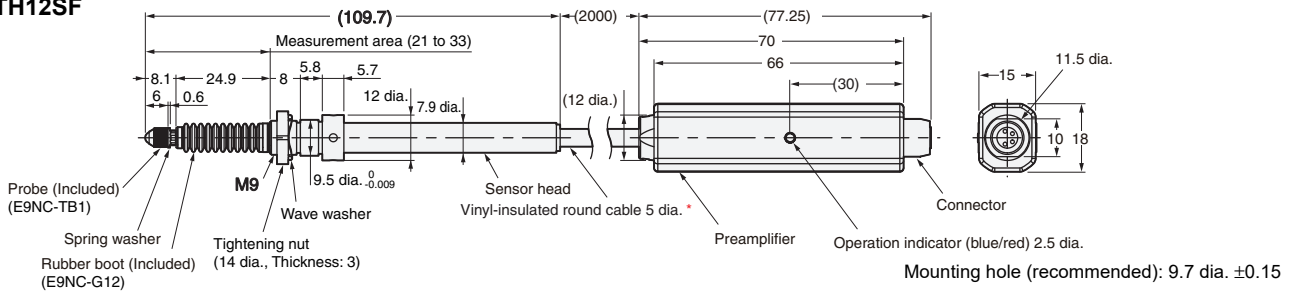

E9NC-TH12LF

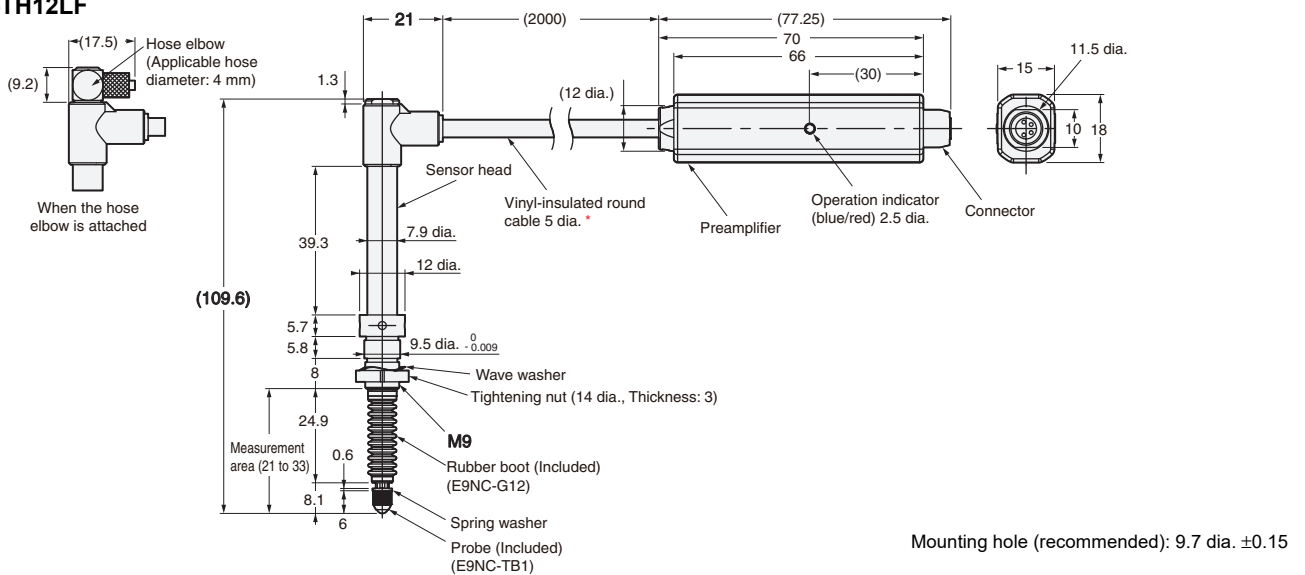

* The minimum bending radiuses of the Sensor Head cable are shown below.
 Repeated flexing: 50 mm
 Permanent bend: 20 mm

E9NC-T

Amplifier Units

Model with Communications

E9NC-TA0

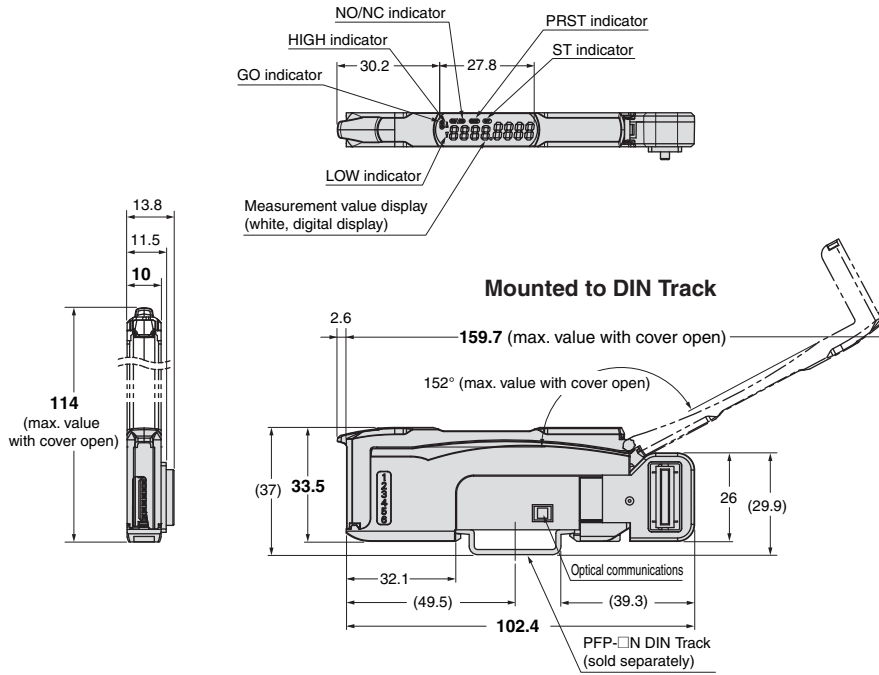

Models with ON/OFF Outputs

E9NC-TA21

E9NC-TA51



*Cable Specifications
 Vinyl-insulated round cable, 4 dia., 5 conductors
 (Conductor cross-section: 0.2 mm², Insulation diameter: 0.9 mm), Standard cable length: 2 m,
 Minimum bending radius: 12 mm

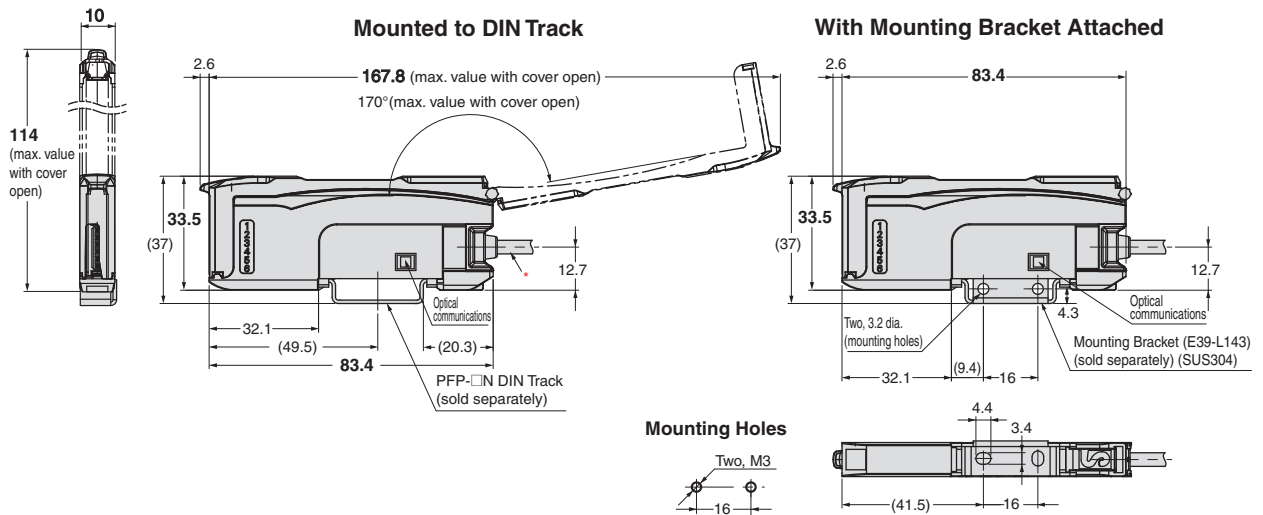
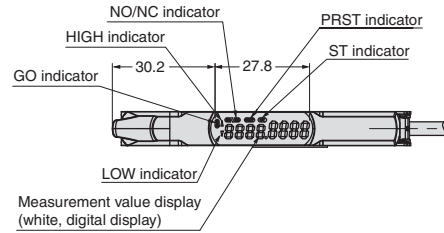

Accessories (Sold Separately)

Probes

E9NC-TB1

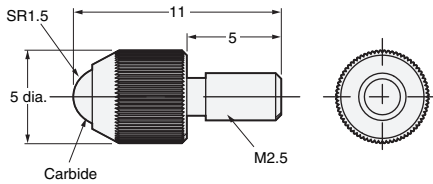

E9NC-TB2

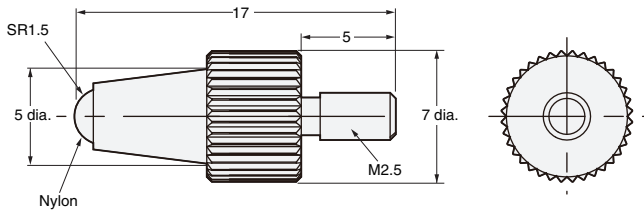

E9NC-TB3

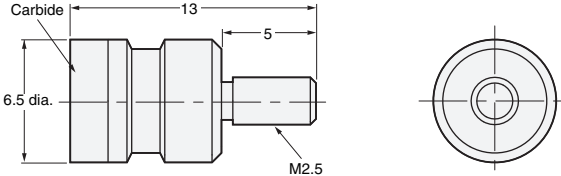

Connection Cables

- E9NC-TXC05
- E9NC-TXC5
- E9NC-TXC10
- E9NC-TXC20

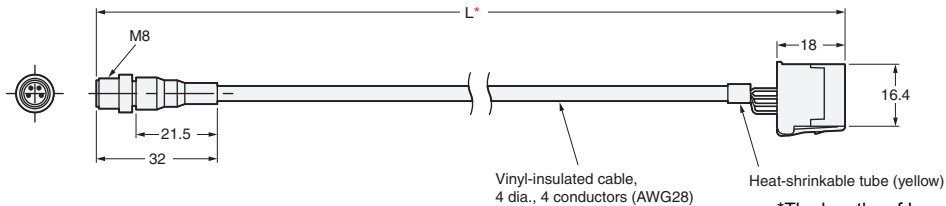

*The lengths of L are shown below.

Model	L (m)
E9NC-TXC05	0.5
E9NC-TXC5	5
E9NC-TXC10	10
E9NC-TXC20	20

Rubber Boots

E9NC-G5

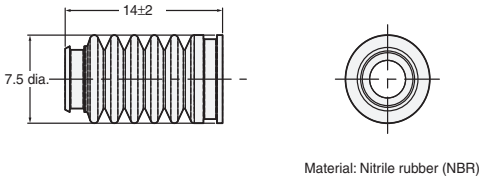

E9NC-G12

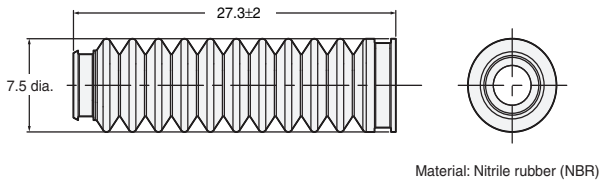

E9NC-T

Amplifier Unit Mounting Bracket

E39-L143

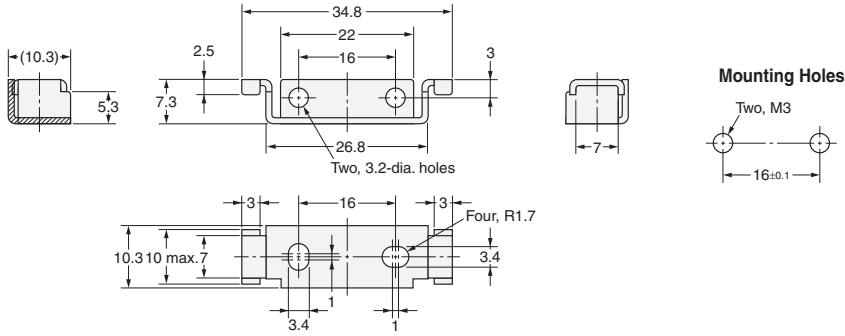
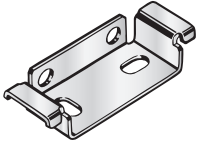

Material: Stainless steel (SUS304)

DIN Tracks

PFP-100N

PFP-50N

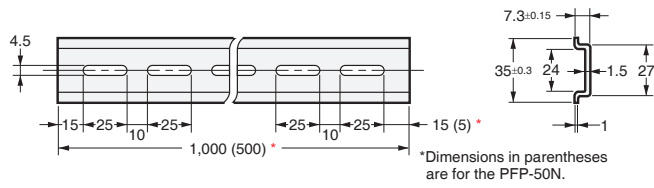

Material: Aluminum

PFP-100N2

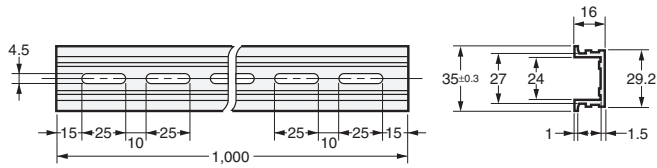

Material: Aluminum

End Plate

PFP-M

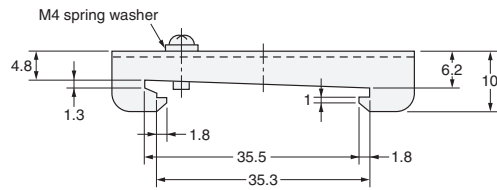
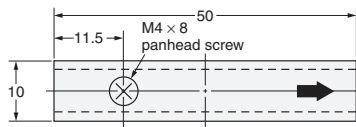

Materials: Iron, zinc plating

Terms and Conditions Agreement

Read and understand this catalog.

Please read and understand this catalog before purchasing the products. Please consult your OMRON representative if you have any questions or comments.

Warranties.

(a) Exclusive Warranty. Omron's exclusive warranty is that the Products will be free from defects in materials and workmanship for a period of twelve months from the date of sale by Omron (or such other period expressed in writing by Omron). Omron disclaims all other warranties, express or implied.

(b) Limitations. OMRON MAKES NO WARRANTY OR REPRESENTATION, EXPRESS OR IMPLIED, ABOUT NON-INFRINGEMENT, MERCHANTABILITY OR FITNESS FOR A PARTICULAR PURPOSE OF THE PRODUCTS. BUYER ACKNOWLEDGES THAT IT ALONE HAS DETERMINED THAT THE PRODUCTS WILL SUITABLY MEET THE REQUIREMENTS OF THEIR INTENDED USE.

Omron further disclaims all warranties and responsibility of any type for claims or expenses based on infringement by the Products or otherwise of any intellectual property right. (c) Buyer Remedy. Omron's sole obligation hereunder shall be, at Omron's election, to (i) replace (in the form originally shipped with Buyer responsible for labor charges for removal or replacement thereof) the non-complying Product, (ii) repair the non-complying Product, or (iii) repay or credit Buyer an amount equal to the purchase price of the non-complying Product; provided that in no event shall Omron be responsible for warranty, repair, indemnity or any other claims or expenses regarding the Products unless Omron's analysis confirms that the Products were properly handled, stored, installed and maintained and not subject to contamination, abuse, misuse or inappropriate modification. Return of any Products by Buyer must be approved in writing by Omron before shipment. Omron Companies shall not be liable for the suitability or unsuitability or the results from the use of Products in combination with any electrical or electronic components, circuits, system assemblies or any other materials or substances or environments. Any advice, recommendations or information given orally or in writing, are not to be construed as an amendment or addition to the above warranty.

See <http://www.omron.com/global/> or contact your Omron representative for published information.

Limitation on Liability: Etc.

OMRON COMPANIES SHALL NOT BE LIABLE FOR SPECIAL, INDIRECT, INCIDENTAL, OR CONSEQUENTIAL DAMAGES, LOSS OF PROFITS OR PRODUCTION OR COMMERCIAL LOSS IN ANY WAY CONNECTED WITH THE PRODUCTS, WHETHER SUCH CLAIM IS BASED IN CONTRACT, WARRANTY, NEGLIGENCE OR STRICT LIABILITY.

Further, in no event shall liability of Omron Companies exceed the individual price of the Product on which liability is asserted.

Suitability of Use.

Omron Companies shall not be responsible for conformity with any standards, codes or regulations which apply to the combination of the Product in the Buyer's application or use of the Product. At Buyer's request, Omron will provide applicable third party certification documents identifying ratings and limitations of use which apply to the Product. This information by itself is not sufficient for a complete determination of the suitability of the Product in combination with the end product, machine, system, or other application or use. Buyer shall be solely responsible for determining appropriateness of the particular Product with respect to Buyer's application, product or system. Buyer shall take application responsibility in all cases.

NEVER USE THE PRODUCT FOR AN APPLICATION INVOLVING SERIOUS RISK TO LIFE OR PROPERTY OR IN LARGE QUANTITIES WITHOUT ENSURING THAT THE SYSTEM AS A WHOLE HAS BEEN DESIGNED TO ADDRESS THE RISKS, AND THAT THE OMRON PRODUCT(S) IS PROPERLY RATED AND INSTALLED FOR THE INTENDED USE WITHIN THE OVERALL EQUIPMENT OR SYSTEM.

Programmable Products.

Omron Companies shall not be responsible for the user's programming of a programmable Product, or any consequence thereof.

Performance Data.

Data presented in Omron Company websites, catalogs and other materials is provided as a guide for the user in determining suitability and does not constitute a warranty. It may represent the result of Omron's test conditions, and the user must correlate it to actual application requirements. Actual performance is subject to the Omron's Warranty and Limitations of Liability.

Change in Specifications.

Product specifications and accessories may be changed at any time based on improvements and other reasons. It is our practice to change part numbers when published ratings or features are changed, or when significant construction changes are made. However, some specifications of the Product may be changed without any notice. When in doubt, special part numbers may be assigned to fix or establish key specifications for your application. Please consult with your Omron's representative at any time to confirm actual specifications of purchased Product.

Errors and Omissions.

Information presented by Omron Companies has been checked and is believed to be accurate; however, no responsibility is assumed for clerical, typographical or proofreading errors or omissions.

Note: Do not use this document to operate the Unit.

OMRON Corporation Industrial Automation Company

Kyoto, JAPAN

Contact : www.ia.omron.com

Regional Headquarters

OMRON EUROPE B.V.

Wegalaan 67-69, 2132 JD Hoofddorp
The Netherlands
Tel: (31) 2356-81-300 Fax: (31) 2356-81-388

OMRON ELECTRONICS LLC

2895 Greenspoint Parkway, Suite 200
Hoffman Estates, IL 60169 U.S.A.
Tel: (1) 847-843-7900 Fax: (1) 847-843-7787

OMRON ASIA PACIFIC PTE. LTD.

438B Alexandra Road, #08-01/02 Alexandra
Technopark, Singapore 119968
Tel: (65) 6835-3011 Fax: (65) 6835-3011

OMRON (CHINA) CO., LTD.

Room 2211, Bank of China Tower,
200 Yin Cheng Zhong Road,
PuDong New Area, Shanghai, 200120, China
Tel: (86) 21-6023-0333 Fax: (86) 21-5037-2388

Authorized Distributor:

©OMRON Corporation 2013-2024 All Rights Reserved.
In the interest of product improvement,
specifications are subject to change without notice.

CSM_10_4

Cat. No. E434-E1-04 1124 (0413)