

## IO-Link Makes Sensor Level Information Visible and Solves the Three Major Issues at Manufacturing Sites! Standard Photoelectric Sensor.



- Downtime can be reduced.  
Notifies you of faulty parts and such phenomena in the Sensor in real time.
- The frequency of sudden failure can be decreased.  
The light incident level monitor prevents false detection before it happens.
- The efficiency of changeover can be improved.  
The batch check for individual sensor IDs significantly decreases commissioning time.
- Three types of sensing methods and three types of connection methods are available.



For the most recent information on models that have been certified for safety standards, refer to your OMRON website.

Be sure to read *Safety Precautions* on page 9.

## Ordering Information

### IO-Link Model / Sensors [Refer to *Dimensions* on page 10.]

Red light Infrared light

Sensing method	Appearance	Connection method	Sensing distance			IO-Link baud rate	Model						
							PNP						
Through-beam (Emitter + Receiver) *3		Pre-wired (2 m)		15 m		COM2 (38.4 kbps)	<b>E3Z-T81-IL2 2M</b> Emitter E3Z-T81-L-IL2 2M Receiver E3Z-T81-D-IL2 2M						
		Pre-wired M12 connector					<b>E3Z-T81-M1TJ-IL2 0.3M</b> Emitter E3Z-T81-L-M1TJ-IL2 0.3M Receiver E3Z-T81-D-M1TJ-IL2 0.3M						
		Standard M8 connector					<b>E3Z-T86-IL2</b> Emitter E3Z-T86-L-IL2 Receiver E3Z-T86-D-IL2						
		Pre-wired (2 m)					COM3 (230.4 kbps)	<b>E3Z-T81-IL3 2M</b> Emitter E3Z-T81-L-IL3 2M Receiver E3Z-T81-D-IL3 2M					
		Pre-wired M12 connector						<b>E3Z-T81-M1TJ-IL3 0.3M</b> Emitter E3Z-T81-L-M1TJ-IL3 0.3M Receiver E3Z-T81-D-M1TJ-IL3 0.3M					
		Standard M8 connector						<b>E3Z-T86-IL3</b> Emitter E3Z-T86-L-IL3 Receiver E3Z-T86-D-IL3					
		Retro-reflective with MSR function							Pre-wired (2 m)		4 m (100 mm) <small>(When using E39-R1S)</small>	COM2 (38.4 kbps)	<b>E3Z-R81-IL2 2M</b>
									Pre-wired M12 connector				<b>E3Z-R81-M1TJ-IL2 0.3M</b>
									Standard M8 connector				<b>E3Z-R86-IL2</b>
Pre-wired (2 m)	COM3 (230.4 kbps)		<b>E3Z-R81-IL3 2M</b>										
Pre-wired M12 connector			<b>E3Z-R81-M1TJ-IL3 0.3M</b>										
Standard M8 connector	<b>E3Z-R86-IL3</b>												



**Note:** Please contact your OMRON sales representative regarding the IO-Link setup file (IODD file).

\*1. The Reflector is sold separately. Select the Reflector model most suited to the application.

\*2. The sensing distance specified is possible when the E39-R1S is used. Values in parentheses indicate the minimum required distance between the Sensor and Reflector.

\*3. Through-beam Sensors are normally sold in sets that include both the Emitter and Receiver.

 Red light
  Infrared light

Sensing method	Appearance	Connection method	Sensing distance			IO-Link baud rate	Model	
							PNP	
Diffuse-reflective		Pre-wired (2 m)		1 m		COM2 (38.4 kbps)	E3Z-D82-IL2 2M	
		Pre-wired M12 connector					E3Z-D82-M1TJ-IL2 0.3M	
		Standard M8 connector					E3Z-D87-IL2	
		Pre-wired (2 m)					E3Z-D82-IL3 2M	
		Pre-wired M12 connector					E3Z-D82-M1TJ-IL3 0.3M	
		Standard M8 connector					E3Z-D87-IL3	
		Pre-wired (2 m)		90 mm (narrow beam)		COM2 (38.4 kbps)	E3Z-L81-IL2 2M	
		Pre-wired M12 connector					E3Z-L81-M1TJ-IL2 0.3M	
		Standard M8 connector					E3Z-L86-IL2	
		Pre-wired (2 m)					COM3 (230.4 kbps)	E3Z-L81-IL3 2M
		Pre-wired M12 connector						E3Z-L81-M1TJ-IL3 0.3M
		Standard M8 connector						E3Z-L86-IL3

**Note:** Please contact your OMRON sales representative regarding the IO-Link setup file (IODD file).

### Accessories (Sold Separately)

**Slit** (A Slit is not provided with Through-beam Sensors) Order a Slit separately if required.

Slit width	Sensing distance	Minimum detectable object (Reference value)	Model	Contents
	E3Z-T□□			
0.5-mm dia.	50 mm	0.2-mm dia.	E39-S65A	One set (contains Slits for both the Emitter and Receiver)
1-mm dia.	200 mm	0.4-mm dia.	E39-S65B	
2-mm dia.	800 mm	0.7-mm dia.	E39-S65C	
0.5 × 10 mm	1 m	0.2-mm dia.	E39-S65D	
1 × 10 mm	2.2 m	0.5-mm dia.	E39-S65E	
2 × 10 mm	5 m	0.8-mm dia.	E39-S65F	

**Reflectors** (Reflector required for Retroreflective Sensors) A Reflector is not provided with the Sensor. Be sure to order a Reflector separately.

Name	Sensing distance *		Model	Quantity	Remarks
	E3Z-R				
	Rated value	Reference value			
Reflector	3 m (100 mm)	---	E39-R1	1	<ul style="list-style-type: none"> <li>Reflectors are not provided with Retro-reflective models.</li> <li>The MSR function of the E3Z-R□ is enabled.</li> </ul>
	4 m (100 mm)	---	E39-R1S	1	
	---	5 m (100 mm)	E39-R2	1	
	---	2.5 m (100 mm)	E39-R9	1	
	---	3.5 m (100 mm)	E39-R10	1	
Fog Preventive Coating	---	3 m (100 mm)	E39-R1K	1	
Small Reflector	---	1.5 m (50 mm)	E39-R3	1	
Tape Reflector	---	700 mm (150 mm)	E39-RS1	1	
	---	1.1 m (150 mm)	E39-RS2	1	
	---	1.4 m (150 mm)	E39-RS3	1	









**Note:** 1. If you use the Reflector at any distance other than the rated distance, make sure that the stability indicator lights properly when you install the Sensor.

2. Refer to *Reflectors on E39-L/E39-S/E39-R* on your OMRON website for details.

\* Values in parentheses indicate the minimum required distance between the Sensor and Reflector.

### Mounting Brackets

A Mounting Bracket is not enclosed with the Sensor. Order a Mounting Bracket separately if required.

Appearance	Model (material)	Quantity	Remarks	Appearance	Model (material)	Quantity	Remarks
	<b>E39-L153 (SUS304) *1</b>	1	Mounting Brackets		<b>E39-L98 (SUS304) *2</b>	1	Metal Protective Cover Bracket
	<b>E39-L104 (SUS304) *1</b>	1			<b>E39-L150 (SUS304)</b>	1	(Sensor adjuster)
	<b>E39-L43 (SUS304) *2</b>	1	Horizontal Mounting Brackets		<b>E39-L151 (SUS304)</b>	1	Easily mounted to the aluminum frame rails of conveyors and easily adjusted.
	<b>E39-L142 (SUS304) *2</b>	1	Horizontal Protective Cover Bracket				For left to right adjustment
	<b>E39-L44 (SUS304)</b>	1	Rear Mounting Bracket		<b>E39-L144 (SUS304) *2</b>	1	Compact Protective Cover Bracket (For E3Z only)

**Note:** 1. When using Through-beam models, order one bracket for the Receiver and one for the Emitter.







2. Refer to *Mounting Brackets on E39-L/E39-S/E39-R* on your OMRON website for details.

\*1. Cannot be used for Standard Connector models with mounting surface on the bottom. In that case, use Pre-wired Connector models.

\*2. Cannot be used for Standard Connector models.

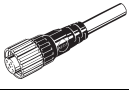
### Sensor I/O Connectors

(Models for Connectors and Pre-wired Connectors: A Connector is not provided with the Sensor. Be sure to order a Connector separately.)

Size	Type	Appearance	Cable length	Model
M12	Socket on one cable end	Smartclick connector Straight *2 	2 m	<b>XS5F-D421-D80-F</b>
			5 m	<b>XS5F-D421-G80-F</b>
		Smartclick connector L-shape *2 *3 	2 m	<b>XS5F-D422-D80-F</b>
			5 m	<b>XS5F-D422-G80-F</b>
	Socket and plug on cable ends *1	Smartclick connector Straight/ Straight *2 	2 m	<b>XS5W-D421-D81-F</b>
			5 m	<b>XS5W-D421-G81-F</b>
Smartclick connector L-shape/L-shape *2 *3 		2 m	<b>XS5W-D422-D81-F</b>	
		5 m	<b>XS5W-D422-G81-F</b>	
M8	Socket on one cable end	Straight *3 	2 m	<b>XS3F-M421-402-A</b>
			5 m	<b>XS3F-M421-405-A</b>
		L-shape *3 *4 	2 m	<b>XS3F-M422-402-A</b>
			5 m	<b>XS3F-M422-405-A</b>
M8 socket/ M12 plug	Socket and plug on cable ends	M8-M12 (Smartclick) conversion cable *2 	0.2 m	<b>XS3W-M42C-4C2-A</b>

**Note:** 1. When using Through-beam models, order one connector for the Receiver and one for the Emitter.

2. Refer to *Sensor I/O Connectors/Sensor Controllers* on your OMRON website for details.

\*1. Straight type/L-shape type combinations are also available.

\*2. The connectors will not rotate after they are connected.

\*3. The cable is fixed at an angle of 180° from the sensor emitter/receiver surface.

## Ratings and Specifications

### IO-Link Model

Model Item	Sensing method		Through-beam	Retro-reflective with MSR function	Diffuse-reflective	Narrow-beam Models
	PNP output	Pre-wired	E3Z-T81-IL□	E3Z-R81-IL□	E3Z-D82-IL□	E3Z-L81-IL□
		Pre-wired connector (M12)	E3Z-T81-M1TJ-IL□	E3Z-R81-M1TJ-IL□	E3Z-D82-M1TJ-IL□	E3Z-L81-M1TJ-IL□
		Connector (M8)	E3Z-T86-IL□	E3Z-R86-IL□	E3Z-D87-IL□	E3Z-L86-IL□
Sensing distance		15 m	4 m (100 mm) * (when using E39-R1S) 3 m (100 mm) * (when using E39-R1)	1 m (white paper: 300 × 300 mm)	90 + 30 mm (white paper: 100 × 100 mm)	
Spot diameter (reference value)		---				2.5 dia. and sensing distance of 90 mm
Standard sensing object		Opaque: 12-mm dia. min.	Opaque: 75-mm dia. min.	---		
Minimum detectable object (reference value)		---				0.1 mm (copper wire)
Differential travel (representative example)		---	---	20% max. of setting distance	Refer to <i>Engineering data</i> on page 6.	
Directional angle		Both emitter and receiver: 3 to 15°	2 to 10°	---		
Light source (wavelength)		Infrared LED (870 nm)	Red LED (660 nm)	Infrared LED (870 nm)	Red LED (650 nm)	
Power supply voltage		10 to 30 VDC (including 10% ripple (p-p))				
Current consumption		50 mA max. (Emitter: 25 mA max., Receiver: 25 mA max.)	30 mA max.			
Control output		Load power supply voltage: 30 VDC max., Load current: 100 mA max. Residual voltage: Load current of less than 10 mA: 1 V max. Load current of 10 to 100 mA: 2 V max. PNP open collector output Light-ON/Dark-ON selectable				
Indicators		In the Standard I/O mode (SIO mode): Operation indicator (orange, lit) and stability indicator (green, lit) In the IO-Link Mode: Operation indicator (orange, lit) and communication indicator (green, blinking at 1 s intervals)				
Protection circuits		Reversed power supply polarity protection, output short-circuit protection, and reversed output polarity protection	Reversed power supply polarity protection, output short-circuit protection, reversed output polarity protection, and mutual interference prevention			
Response time		Operate or reset: 1 ms max.				
Sensitivity adjustment		Sensitivity adjuster / IO-Link communications				
Ambient illumination (Receiver side)		Incandescent lamp: 3,000 lx max. Sunlight: 10,000 lx max.				
Ambient temperature range		Operating: -25 to 55°C (with no icing or condensation) Storage: -40 to 70°C (with no icing or condensation)				
Ambient humidity range		Operating: 35% to 85%, Storage: 35% to 95% (with no condensation)				
Insulation resistance		20 MΩ min. at 500 VDC				
Dielectric strength		1,000 VAC, 50/60 Hz for 1 min				
Vibration resistance		Destruction: 10 to 55 Hz, 1.5 mm double amplitude for 2 hours each in X, Y, and Z directions				
Shock resistance		Destruction: 500 m/s <sup>2</sup> 3 times each in X, Y, and Z directions				
Degree of protection		IEC 60529 IP67				
Connection method		Pre-wired cable (standard cable length 2 m), M12 pre-wired connector (standard cable length 0.3 m), M8 connector				
Weight (packed state)	Pre-wired cable (2 m)	Approx. 120 g	Approx. 65 g			
	Pre-wired connector (M12)	Approx. 60 g	Approx. 30 g			
	Connector (M8)	Approx. 30 g	Approx. 20 g			
Material	Case	Polybutylene terephthalate (PBT)				
	Display	Modified polyarylate				
	Lens	Modified polyarylate	Methacrylate resin (PMMA)	Modified polyarylate		
Main IO-Link functions		Operation mode switching between Light ON and Dark ON, setup of the instability detection level for light receiving and non-light receiving, timer function of the control output and timer time selecting, instability output (IO-Link mode) ON delay timer time selecting, setup of a teaching level and execution of teaching, setup of light receiving sensitivity level, monitor output, operating hours read-out, and initial reset				
Communication specifications	IO-Link specification	Ver 1.1				
	Baud rate	-IL3: COM3 (230.4 kbps), -IL2: COM2 (38.4 kbps)				
	Data length	PD size: 2 bytes, OD size: 1 byte (M-sequence type: TYPE_2_2)				
	Minimum cycle time	-IL3 (COM3): 1 ms, -IL2 (COM2): 2.3 ms				
MTTFd (Year)		194	374			
Accessories		Instruction manual (Neither Reflectors nor Mounting Brackets are provided with any of the above models.)				

\* Values in parentheses indicate the minimum required distance between the Sensor and Reflector.

# Engineering Data (Reference Value)

## Parallel Operating Range

### Through-beam Models

E3Z-T8□-IL□

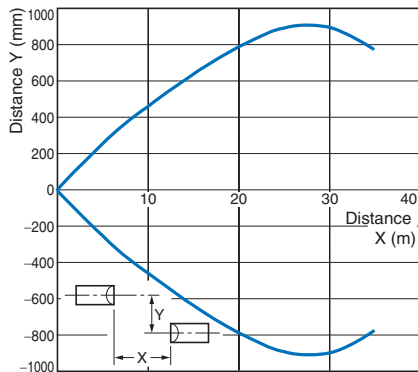

### Through-beam Models

E3Z-T8□-IL□ and Slit

(A Slit is mounted to the Emitter and Receiver.)

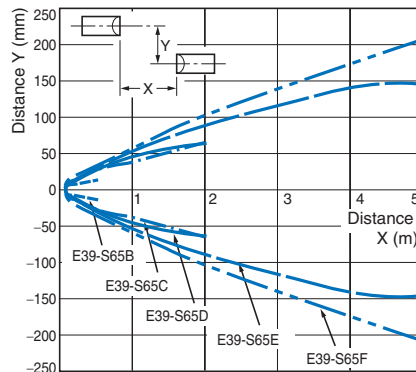

### Retro-reflective Models

E3Z-R8□-IL□ and Reflector

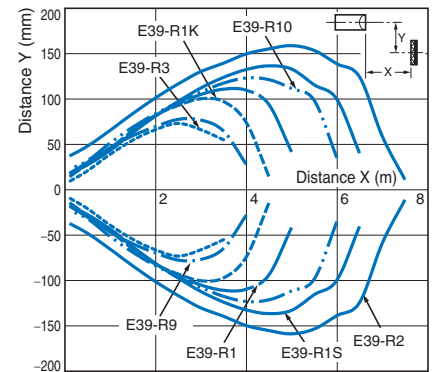

## Operating Range

### Diffuse-reflective Models

E3Z-D8□-IL□

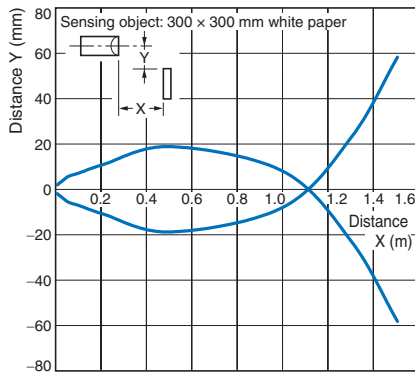

### Narrow-beam Reflective Models

E3Z-L8□-IL□

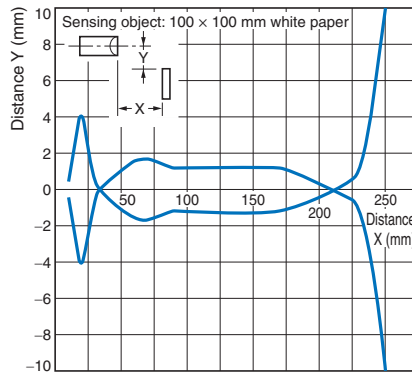

## Monitor Output vs. Sensing Distance

### Through-beam Models

E3Z-T8□-IL□

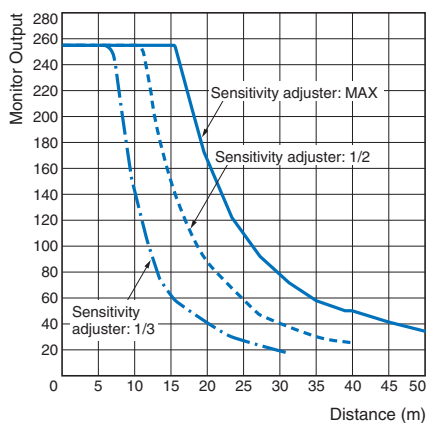

### Retro-reflective Models

E3Z-R8□-IL□ and E39-R1 Reflector

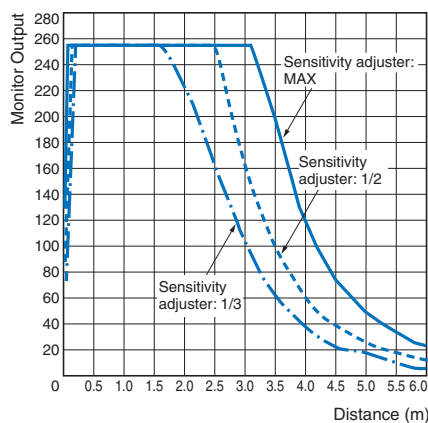

**Monitor Output vs. Sensing Distance**

**Diffuse-reflective Models**

**E3Z-D8□-IL□**

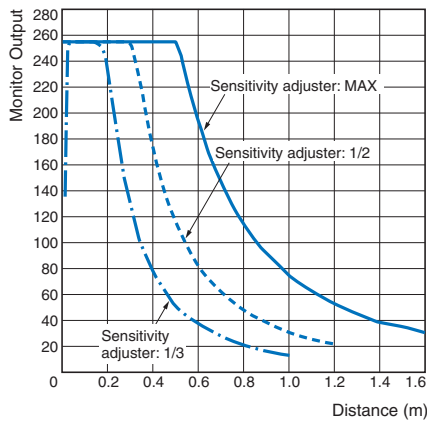

**Narrow-beam Reflective Models**

**E3Z-L8□-IL□**

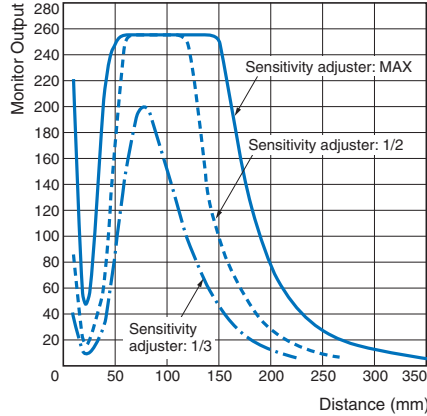

**Sensing Object Size vs. Sensing Distance**

**Diffuse-reflective Models**

**E3Z-D8□-IL□**

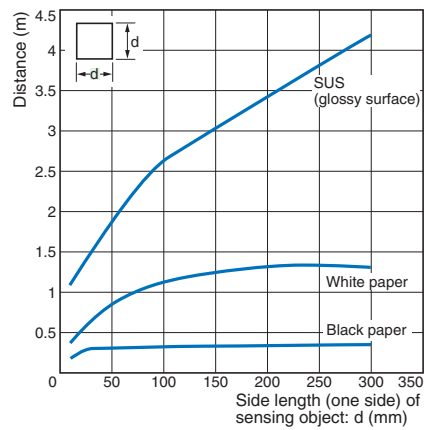

**Narrow-beam Reflective Models**

**E3Z-L8□-IL□**

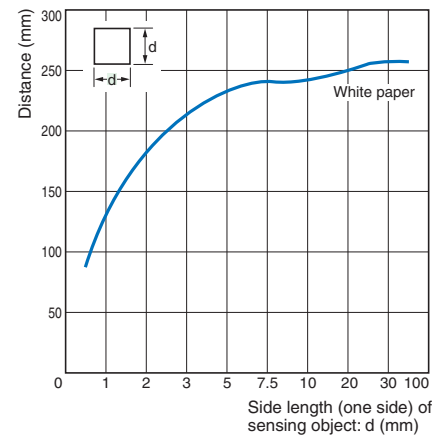

**Spot Diameter vs. Sensing Distance**

**Narrow-beam Reflective Models**

**E3Z-L8□-IL□**

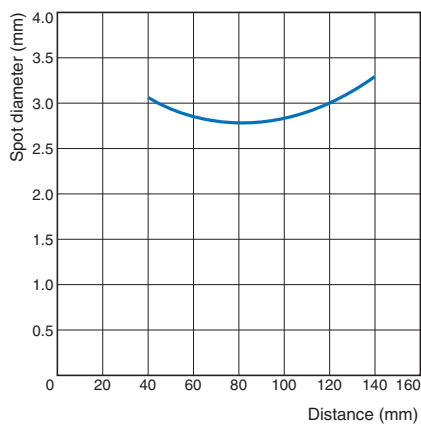

**Differential Travel vs. Sensing Distance**

**Narrow-beam Reflective Models**

**E3Z-L8□-IL□**

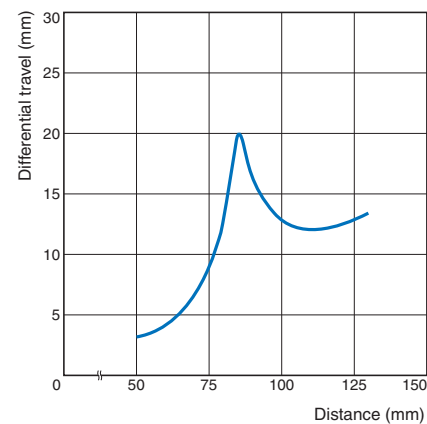

# I/O Circuit Diagrams

## Timing Chart

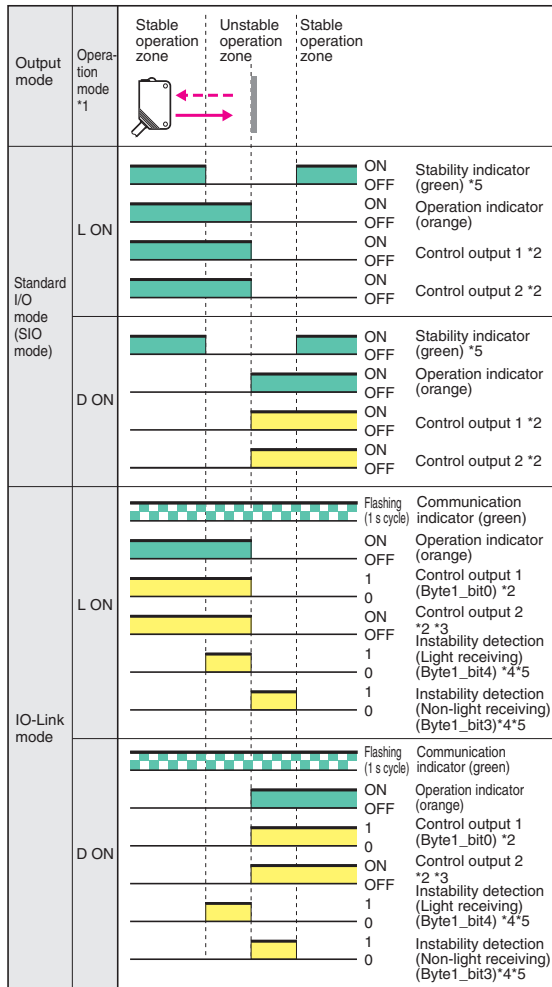

**Note:** Please contact your OMRON sales representative regarding assignment of data.

- \*1. The operation mode can be changed by the IO-Link communications.
- \*2. The timer function can be set up using the IO-Link communications for control output 1 and 2 separately. (It is able to select ON delay, OFF delay, or one-shot function and select a timer time of 1 to 4000 ms (T).)
- \*3. In the IO-Link mode, if the ON/OFF speed of the sensor is slow, high-speed response of 1 ms or less can be realized using control output 2 as a sensor.
- \*4. The judgment time for the instability detection diagnosis can be selected using the IO-Link communications. (For the ON delay timer function to detect instability, the setting can be selected from 0 (invalid), 10, 50, 100, 300, 500, or 1000 ms.
- \*5. The judgment condition for the light receiving/non-light receiving instability detection function can be selected using the IO-Link communications. (Setting of light receiving instability detection threshold: 500%/400%/300%/200%/140%, setting of non-light receiving instability detection threshold: 70%/50%)

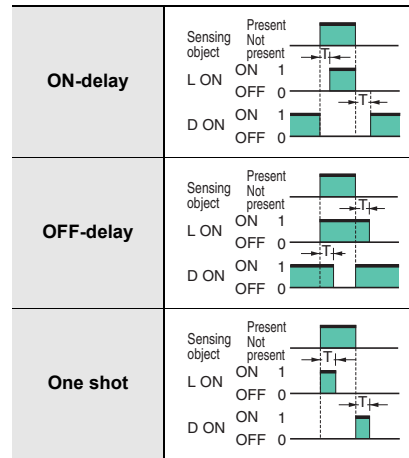

## Output circuit

### Reflective / Receiver of Through-beam Model

#### E3Z-□8□-IL□

When using as a general sensor

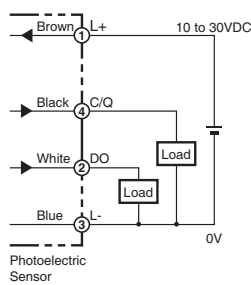

When using the Sensor connected to IO-Link Master Unit

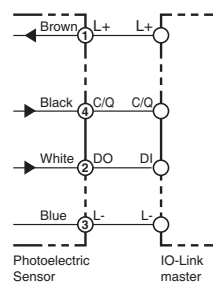

#### Connector Pin Arrangement

Pre-wired M12 connector  
 E3Z-□81-M1TJ-IL□  
 E3Z-□82-M1TJ-IL□  
 E3Z-T81-D-M1TJ-IL□

Standard M8 connector  
 E3Z-□86-IL□  
 E3Z-□87-IL□  
 E3Z-T86-D-IL□



### Emitter of Through-beam Model

#### E3Z-T8□-L-IL□

When using as a general sensor

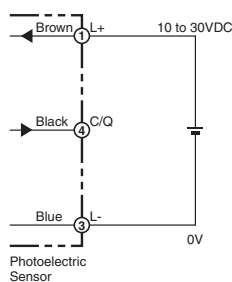

When using the Sensor connected to IO-Link Master Unit

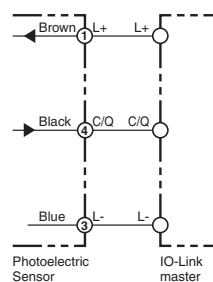

#### Connector Pin Arrangement

E3Z-T81-L-M1TJ-IL□

E3Z-T86-L-IL□



**Note:** Pins 2 is not used.

**Note:** Pins 2 is not used.

Plugs (Sensor I/O Connectors)

M8 connector

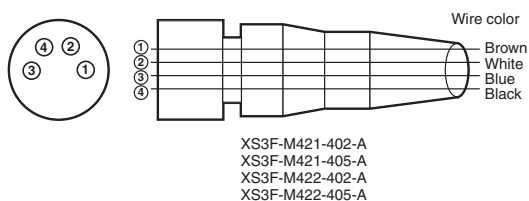

M12 connector

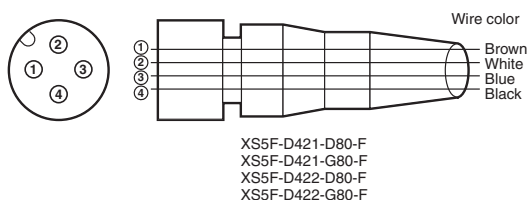

M8-M12 (Smartclick) conversion cable

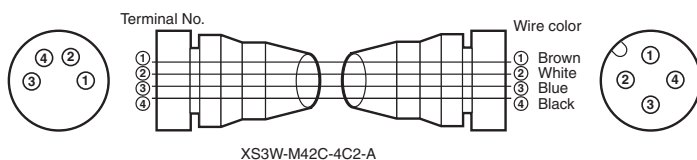

Nomenclature

Through-beam Models  
E3Z-T8□-IL□ (Receiver)

Retro-reflective Models  
E3Z-R8□-IL□

Diffuse-reflective Models  
E3Z-D8□-IL□  
E3Z-L8□-IL□

In the Standard I/O mode (SIO mode):  
Stability indicator (green)

In the IO-Link mode:  
IO-Link communication indicator (green)

Operation selector

Operation indicator (orange)

Sensitivity adjuster



Through-beam Models (Emitter)

Pin arrangement

Classification	Wire color	Connector pin No.	Application
DC	Brown	1	Power supply (+V)
	White	2	-
	Blue	3	Power supply (0 V)
	Black	4	Output C/Q

Note: Pins 2 is not used.

Through-beam Models (Receiver)

Retro-reflective Models  
Diffuse-reflective Models

Pin arrangement

Classification	Wire color	Connector pin No.	Application
DC	Brown	1	Power supply (+V)
	White	2	Output DO
	Blue	3	Power supply (0 V)
	Black	4	Output C/Q





## Safety Precautions

Be sure to read the precautions for all models in the website at: <http://www.ia.omron.com/>.

### Warning Indications

 <b>WARNING</b>	<b>Warning level</b> Indicates a potentially hazardous situation which, if not avoided, will result in minor or moderate injury, or may result in serious injury or death. Additionally there may be significant property damage.
<b>Precautions for Safe Use</b>	Supplementary comments on what to do or avoid doing, to use the product safely.
<b>Precautions for Correct Use</b>	Supplementary comments on what to do or avoid doing, to prevent failure to operate, malfunction or undesirable effect on product performance.

### Meaning of Product Safety Symbols

	<b>General prohibition</b> Indicates the instructions of unspecified prohibited action.
	<b>Caution, explosion</b> Indicates the possibility of explosion under specific conditions.
	<b>Caution, fire</b> Indicates the possibility of fires under specific conditions.

### WARNING

This product is not designed or rated for ensuring safety of persons either directly or indirectly. Do not use it for such purposes.



The maximum power supply voltage is 30 VDC. Before turning the power ON, make sure that the power supply voltage does not exceed the maximum voltage.



Never use the product with an AC power supply. Otherwise, explosion may result.



Do not use the product with voltage in excess of the rated voltage. Excess voltage may result in malfunction or fire.



Do not use the product above rated load.



### Precautions for Safe Use

Be sure to follow the safety precautions below for added safety.

1. Do not use the sensor under the environment with explosive or ignition gas.
2. Never disassemble, repair nor tamper with the product.

### Precautions for Correct Use

1. Do not use the product under the following conditions.
  - (1) In the place exposed to the direct sunlight.
  - (2) In the place where humidity is high and condensation may occur.
  - (3) In the place where vibration or shock is directly transmitted to the product.
2. Connection and Mounting
  - (1) If the sensor wiring is placed in the same conduits or ducts as high-voltage or high-power lines, inductive noise may cause malfunction or damage. Wire the cables separately or use a shielded cable.
  - (2) Use an extension cable less than 100 m long for Standard I/O mode and less than 20 m for IO-Link mode.
  - (3) Do not exceed the following force values applied to the cable. Tensile: 80 N max., torque: 0.1 Nm max., pressure: 20 N max., flexure: 3 kg max.

**M8 metal connectors**

  - (4) Fasten a fixed implement by hand. If you use pliers, it may cause malfunction or damage to it.
3. Cleaning  
Do not use thinner, alcohol, or other organic solvents. Otherwise, the optical properties and degree of protection may be degraded.
4. Power supply  
When using a commercially available switching regulator, be sure to ground the FG (Frame Ground) terminals.
5. Power supply reset time  
The photoelectric sensor will begin sensing no later than 100 ms after the power is turned on. If the load and the photoelectric sensor is connected to different power supply, the photoelectric sensor must be always turned on first.
6. Turning off the power supply  
When turning off the power, output pulse may be generated. We recommend turning off the power supply of the load or load line first.
7. Water resistance  
Though this is type IP67, do not use in the water, rain or outdoors.
8. Please process it as industrial waste.

# Dimensions

Tolerance class IT16 applies to dimensions in this data sheet unless otherwise specified.

## Sensors

### Through-beam Models \*

#### Pre-wired Models

#### E3Z-T81-IL□

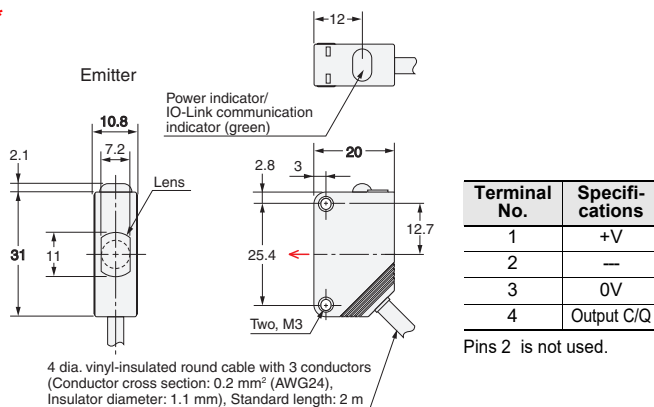

#### Pre-wired M12 connector (E3Z-T□□-M12J)

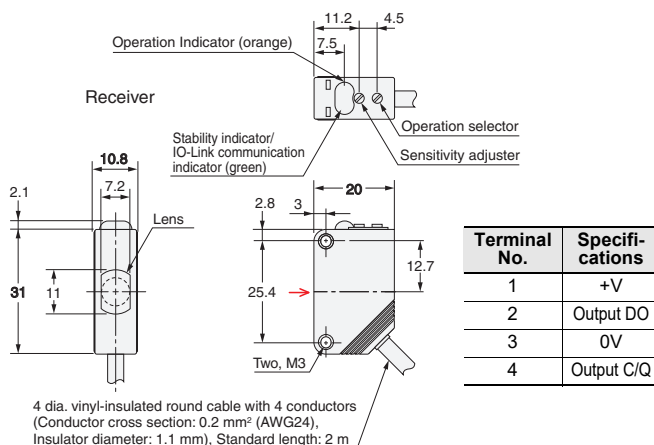
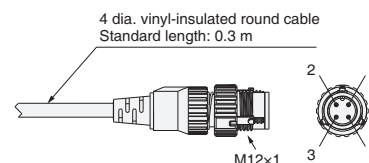

### Through-beam Models \*

#### Connector Models

#### E3Z-T86-IL□

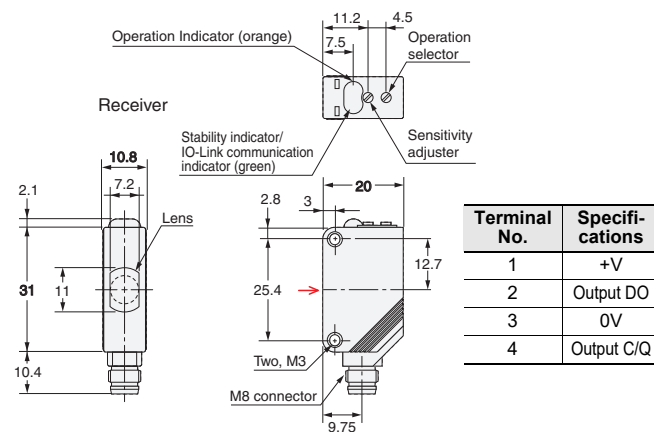
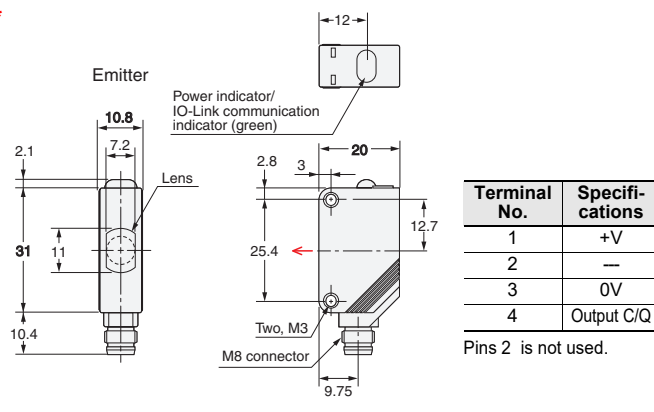

\* Models numbers for Through-beam Sensors (E3Z-T□□) are for sets that include both the Emitter and Receiver. The model number of the Emitter is expressed by adding "-L" to the set model number (example: E3Z-T81-IL□-L 2M), the model number of the Receiver, by adding "-D" (example: E3Z-T81-IL□-D 2M.) Refer to *Ordering Information* to confirm model numbers for Emitter and Receivers.

**Retro-reflective Models**

**Pre-wired Models**

- E3Z-R81-IL□
- E3Z-D82-IL□
- E3Z-L81-IL□

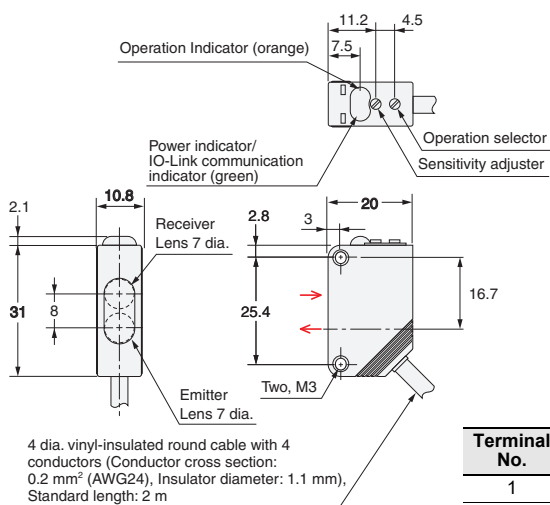

Terminal No.	Specifications
1	+V
2	Output DO
3	0V
4	Output C/Q

**Pre-wired M12 connector (E3Z-□8□-M1TJ)**

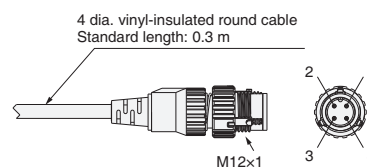

**Retro-reflective Models**

**Connector Models**

- E3Z-R86-IL□
- E3Z-D87-IL□
- E3Z-L86-IL□

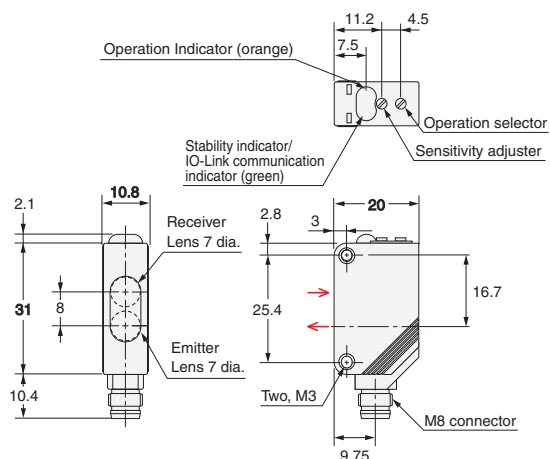

Terminal No.	Specifications
1	+V
2	Output DO
3	0V
4	Output C/Q

Note: The lens for the E3Z-D□2/D□7 is black.

Accessories (Order Separately)

Slits

E39-S65A  
E39-S65B  
E39-S65C

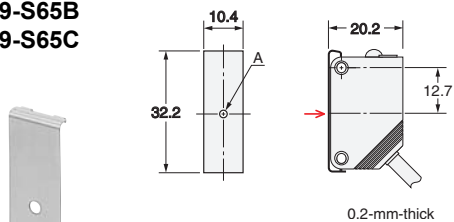

Model	Size A	Material
E39-S65A	0.5 dia.	SUS301 stainless steel
E39-S65B	1.0 dia.	
E39-S65C	2.0 dia.	

Slits

E39-S65D  
E39-S65E  
E39-S65F

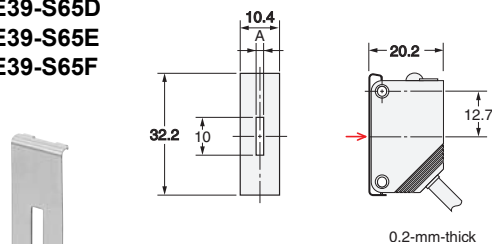

Model	Size A	Material
E39-S65D	0.5	SUS301 stainless steel
E39-S65E	1.0	
E39-S65F	2.0	

Mounting Bracket

E39-L44

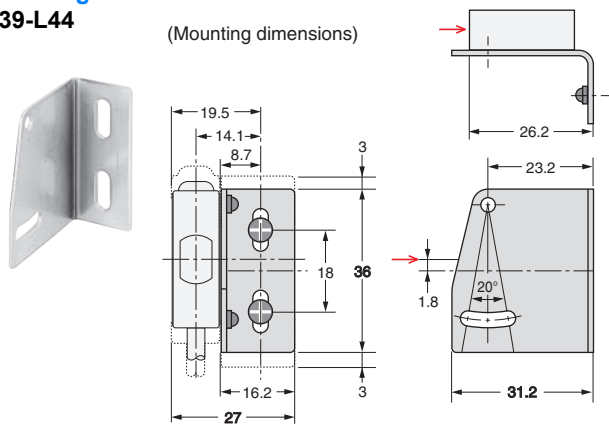

Mounting Bracket

E39-L104

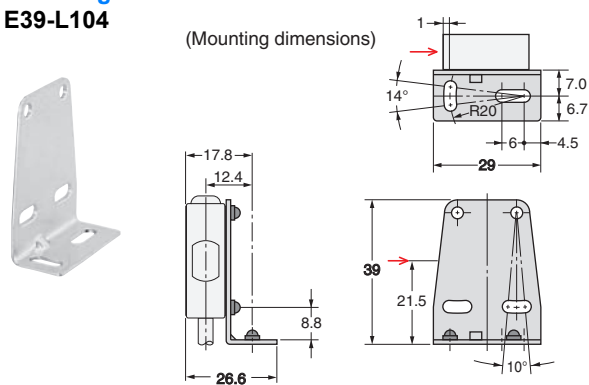

Reflectors

Refer to E39-R on your OMRON website for details.

Sensor I/O Connectors

Refer to XS3 or XS5 on your OMRON website for details.

## Terms and Conditions Agreement

### Read and understand this catalog.

Please read and understand this catalog before purchasing the products. Please consult your OMRON representative if you have any questions or comments.

### Warranties.

(a) Exclusive Warranty. Omron's exclusive warranty is that the Products will be free from defects in materials and workmanship for a period of twelve months from the date of sale by Omron (or such other period expressed in writing by Omron). Omron disclaims all other warranties, express or implied.

(b) Limitations. OMRON MAKES NO WARRANTY OR REPRESENTATION, EXPRESS OR IMPLIED, ABOUT NON-INFRINGEMENT, MERCHANTABILITY OR FITNESS FOR A PARTICULAR PURPOSE OF THE PRODUCTS. BUYER ACKNOWLEDGES THAT IT ALONE HAS DETERMINED THAT THE PRODUCTS WILL SUITABLY MEET THE REQUIREMENTS OF THEIR INTENDED USE.

Omron further disclaims all warranties and responsibility of any type for claims or expenses based on infringement by the Products or otherwise of any intellectual property right. (c) Buyer Remedy. Omron's sole obligation hereunder shall be, at Omron's election, to (i) replace (in the form originally shipped with Buyer responsible for labor charges for removal or replacement thereof) the non-complying Product, (ii) repair the non-complying Product, or (iii) repay or credit Buyer an amount equal to the purchase price of the non-complying Product; provided that in no event shall Omron be responsible for warranty, repair, indemnity or any other claims or expenses regarding the Products unless Omron's analysis confirms that the Products were properly handled, stored, installed and maintained and not subject to contamination, abuse, misuse or inappropriate modification. Return of any Products by Buyer must be approved in writing by Omron before shipment. Omron Companies shall not be liable for the suitability or unsuitability or the results from the use of Products in combination with any electrical or electronic components, circuits, system assemblies or any other materials or substances or environments. Any advice, recommendations or information given orally or in writing, are not to be construed as an amendment or addition to the above warranty.

See <http://www.omron.com/global/> or contact your Omron representative for published information.

### Limitation on Liability: Etc.

OMRON COMPANIES SHALL NOT BE LIABLE FOR SPECIAL, INDIRECT, INCIDENTAL, OR CONSEQUENTIAL DAMAGES, LOSS OF PROFITS OR PRODUCTION OR COMMERCIAL LOSS IN ANY WAY CONNECTED WITH THE PRODUCTS, WHETHER SUCH CLAIM IS BASED IN CONTRACT, WARRANTY, NEGLIGENCE OR STRICT LIABILITY.

Further, in no event shall liability of Omron Companies exceed the individual price of the Product on which liability is asserted.

### Suitability of Use.

Omron Companies shall not be responsible for conformity with any standards, codes or regulations which apply to the combination of the Product in the Buyer's application or use of the Product. At Buyer's request, Omron will provide applicable third party certification documents identifying ratings and limitations of use which apply to the Product. This information by itself is not sufficient for a complete determination of the suitability of the Product in combination with the end product, machine, system, or other application or use. Buyer shall be solely responsible for determining appropriateness of the particular Product with respect to Buyer's application, product or system. Buyer shall take application responsibility in all cases.

NEVER USE THE PRODUCT FOR AN APPLICATION INVOLVING SERIOUS RISK TO LIFE OR PROPERTY OR IN LARGE QUANTITIES WITHOUT ENSURING THAT THE SYSTEM AS A WHOLE HAS BEEN DESIGNED TO ADDRESS THE RISKS, AND THAT THE OMRON PRODUCT(S) IS PROPERLY RATED AND INSTALLED FOR THE INTENDED USE WITHIN THE OVERALL EQUIPMENT OR SYSTEM.

### Programmable Products.

Omron Companies shall not be responsible for the user's programming of a programmable Product, or any consequence thereof.

### Performance Data.

Data presented in Omron Company websites, catalogs and other materials is provided as a guide for the user in determining suitability and does not constitute a warranty. It may represent the result of Omron's test conditions, and the user must correlate it to actual application requirements. Actual performance is subject to the Omron's Warranty and Limitations of Liability.

### Change in Specifications.

Product specifications and accessories may be changed at any time based on improvements and other reasons. It is our practice to change part numbers when published ratings or features are changed, or when significant construction changes are made. However, some specifications of the Product may be changed without any notice. When in doubt, special part numbers may be assigned to fix or establish key specifications for your application. Please consult with your Omron's representative at any time to confirm actual specifications of purchased Product.

### Errors and Omissions.

Information presented by Omron Companies has been checked and is believed to be accurate; however, no responsibility is assumed for clerical, typographical or proofreading errors or omissions.