

Flat Capacitive Sensor with Separate Amplifier Ideal for Mounting on Robot Hands.

- Flat head is only 5.5-mm thick.
- Robotics cable ensures improved flexibility.
- Operation indicator on the Sensor.
- Easy-to-use connector.





 Be sure to read *Safety Precautions* on page 5.

Ordering Information

Sensors

[Refer to *Dimensions* on page 6.]

| Appearance | Sensing distance (variable) | Model |
|--|---|---------------------|
|  Flat, Unshielded |  10 mm (4 to 10 mm) | E2J-W10MA 1M |
| |  20 mm (8 to 20 mm) | E2J-W20MA 1M |

Amplifier Units

| Output configuration | Model |
|---|--------------------|
| DC 3-wire NPN Open-collector output | E2J-JC4A 2M |

Accessories (Order Separately)

Dust Covers A Dust Cover is not provided with the Sensor or Amplifier. Order a Dust Cover separately if required.

[Refer to *Dimensions* on page 6.]

| Appearance | Application | Application | Model |
|---|-------------------|-------------------------|----------------|
|  | Dust protection * | E2J-JC4A Amplifier Unit | XS3Z-13 |
| | | E2J-W□MA Sensor | XS3Z-15 |

* These dust covers are for protection against dust. They do not satisfy IP67. When attaching the Dust Cover, be sure to fully insert the connector into the Dust Cover.

Sensor I/O Connectors with Cables A Connector is not provided with the Sensor. Order a Connector separately if required.

[Refer to *XS3*.]

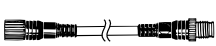
| Appearance | Application | Cable conductors | Cable length | Model | Remarks |
|---|---------------------|------------------|--------------|------------------------|--|
|  | For cable extension | 4 conductors | 1 m | XS3W-M421-401-R | M8-screw-mounting cables Robotics cables (vibration resistant) Straight/Straight Model |
| | | | 2 m | XS3W-M421-402-R | |

Note: Refer to *Introduction to Sensor I/O Connectors/Sensor Controllers* for details.

Ratings and Specifications

Sensors

| Item | Model | |
|--|---|--------------------|
| | E2J-W10MA | E2J-W20MA |
| Sensing distance | 10 mm | 20 mm |
| Sensing distance adjustable range | 4 to 10 mm | 8 to 20 mm |
| Differential travel | 15% max. of sensing distance | |
| Detectable object | Conductors and dielectrics | |
| Standard sensing object | Grounded metal plate: 50 × 50 × 1 mm | |
| Response frequency | 70 Hz min. | |
| Indicators | Detection indicator (yellow) | |
| Ambient temperature range | Operating/Storage: -10 to 55°C (with no icing or condensation) | |
| Ambient humidity range | Operating/Storage: 35% to 85% (with no condensation) | |
| Vibration resistance | Destruction: 10 to 500 Hz, 2-mm double amplitude or 150 m/s ² for 2 hours each in X, Y, and Z directions | |
| Shock resistance | Destruction: 500 m/s ² 3 times each in X, Y, and Z directions | |
| Degree of protection | IP66 (IEC) | |
| Connection method | Pre-wired Connector Models (Robotics cable, Standard cable length: 1m) | |
| Weight (packed state) | Approx. 30 g | Approx. 40 g |
| Materials | Case | Heat-resistant ABS |

Amplifier Units

| Item | Model |
|--|---|
| | E2J-JC4A |
| Power supply voltage | 24 VDC ±20%, ripple (p-p): 10% max. |
| Current consumption | 30 mA max. |
| Control output | Load current NPN open-collector output, 100 mA max. (30 VDC max.) |
| | Residual voltage 1 V max. |
| Indicators | Operation indicator (orange) Power indicator (green) |
| Number of turns of sensitivity adjustment | 8 turns with an indicator |
| Protection circuits | Load short-circuit protection, Surge suppressor, Reverse polarity protection |
| Ambient temperature range | Operating/Storage: -10 to 55°C (with no icing or condensation) |
| Ambient humidity range | Operating/Storage: 35% to 85% (with no condensation) |
| Temperature influence (Sensor with Amplifier) | ±25% max. of sensing distance at 23°C in the temperature range of 0 to 40°C |
| Voltage influence | ±1% max. of sensing distance at the rated voltage in the ±20% rated voltage range |
| Insulation resistance | 50 MΩ min. (at 500 VDC) between current-carrying parts and case |
| Dielectric strength | 1,000 VAC, 50/60 Hz for 1 min between current-carrying parts and case |
| Vibration resistance | Destruction: 10 to 150 Hz, 1.5-mm double amplitude or 100 m/s ² for 2 hours each in X, Y, and Z directions |
| Shock resistance | Destruction: 300 m/s ² 3 times each in X, Y, and Z directions |
| Degree of protection | IP50 (IEC) |
| Connection method | Pre-wired Models (Standard cable length: 2 m) |
| Weight (packed state) | Approx. 60 g |
| Materials | Case ABS |
| Accessories | Mounting Bracket, Instruction manual |

Engineering Data (Reference Value)

Sensing Area

E2J-W10MA

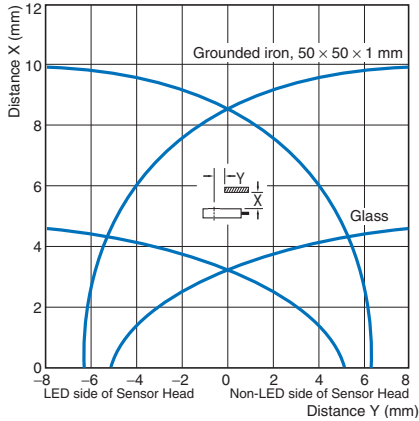

E2J-W20MA

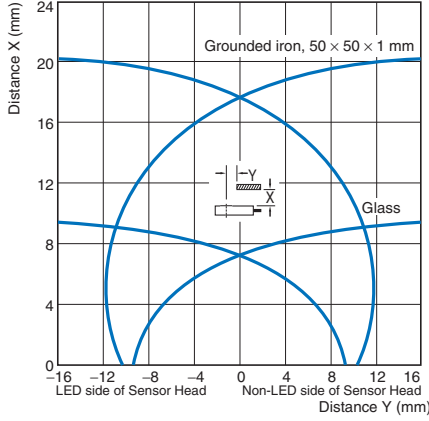

Sensing Distance Change by Sensing Object (Typical)

E2J-W10MA

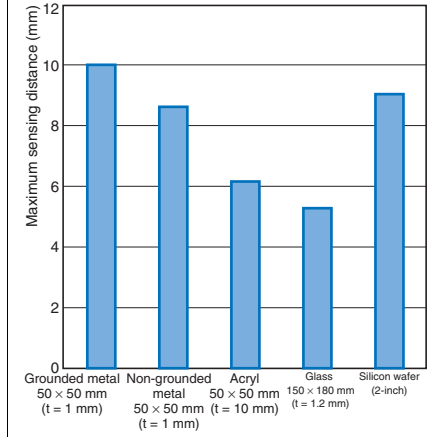

Influence of Sensing Object (Iron)

E2J-W10MA

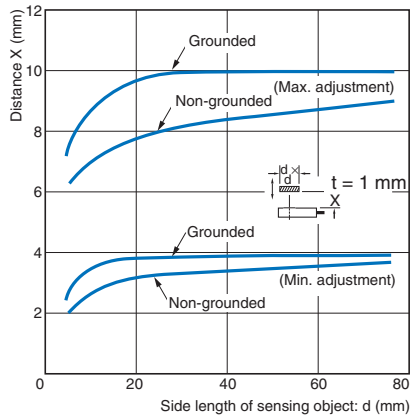

E2J-W20MA

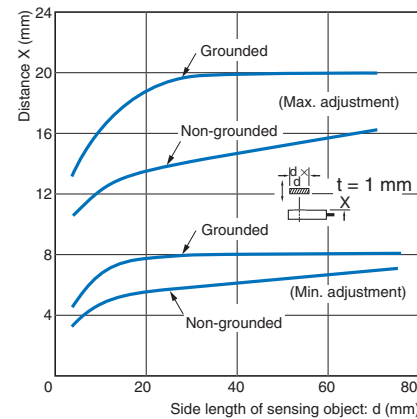

E2J-W20MA

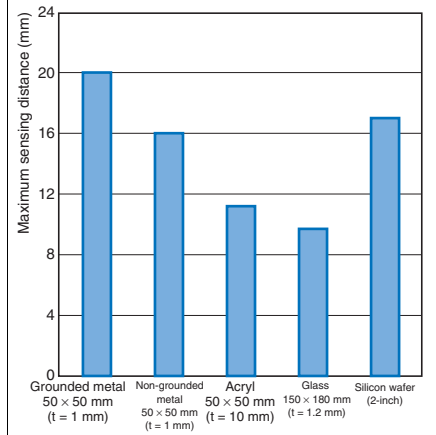

Influence of Ambient Temperature

E2J-W10MA

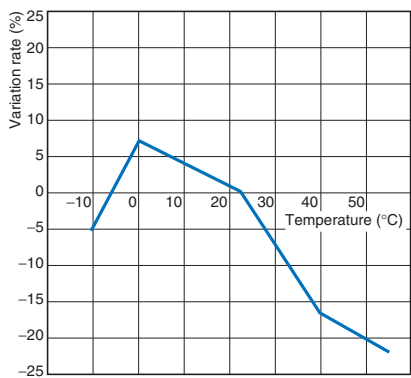

E2J-W20MA

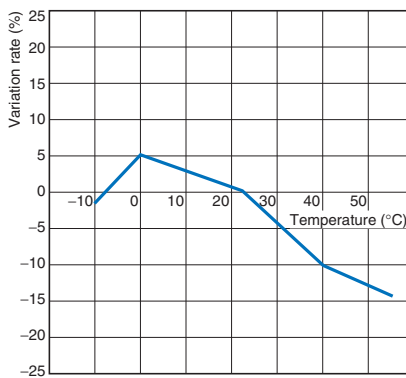

I/O Circuit Diagrams

| Operation mode | Model | Timing chart | Output circuit |
|----------------|---|--|----------------|
| NO | E2J-W10MA E2J-W20MA + E2J-JC4A | Sensing object Present Not present Output transistor ON OFF Sensor detection indicator (yellow) ON OFF Amplifier Unit operation indicator (orange) ON OFF | |
| | | Sensing object Present Not present Output transistor ON OFF Sensor detection indicator (yellow) ON OFF Amplifier Unit operation indicator (orange) ON OFF | |

Amplifier Unit Nomenclature

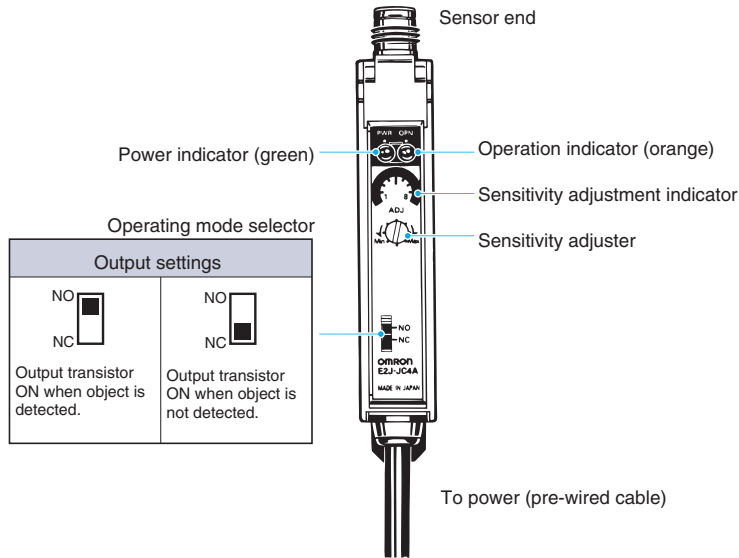

Safety Precautions

Refer to *Warranty and Limitations of Liability*.

⚠ WARNING

This product is not designed or rated for ensuring safety of persons either directly or indirectly. Do not use it for such purposes.



Precautions for Correct Use

Do not use this product under ambient conditions that exceed the ratings.

● **Design**

Influence of Surrounding Metal

When mounting the Sensor within a metal panel, ensure that the clearances given in the following table are maintained. Failure to maintain these distances may cause deterioration in the performance of the Sensor.

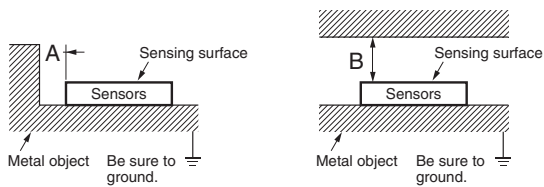

Influence of Surrounding Metal (Unit: mm)

| Model | Dimension | A | B |
|-----------|-----------|----|----|
| E2J-W10MA | | 10 | 20 |
| E2J-W20MA | | 20 | 40 |

Mutual Interference

When installing Sensors face-to-face or side-by-side, ensure that the minimum distances given in the following table are maintained.

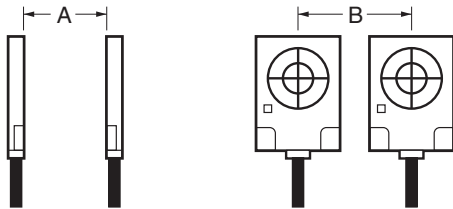

Mutual Interference (Unit: mm)

| Model | Dimension | A | B |
|-----------|-----------|----|----|
| E2J-W10MA | | 20 | 30 |
| E2J-W20MA | | 70 | 50 |

● **Mounting**

Handling

- Do not use the Sensor outdoors.
- Do not wire the Sensor alongside a high-tension or power line.
- Do not use portable telephones or transceivers near the Sensor. Be sure to ground the Mounting Brackets.
- Do not use the Sensor in an environment where it will be exposed to chemicals, particularly chemical solutions or oxidizing acids.

Influence of Static Electricity

Be sure to discharge static electricity before detecting objects that are greatly affected by static electricity.

Mounting the Sensor

The maximum tightening torque that should be applied is 0.54 N·m.

Cable between Sensor and Amplifier Unit

- Be sure that the bending radius of the cable is more than 5 mm.
 - Use the XS3W-M421-40□-R cable with connectors (M8-screw mounting) as the extension cable.
- The maximum cable length is 3 m (extension section: 2 m).

Sensitivity Adjustment

For information on the sensitivity adjustment, refer to *Technical Guide for Operation for information for Proximity Sensor*.

Dimensions

Tolerance class IT16 applies to dimensions in this data sheet unless otherwise specified.

Main Units
Sensors

E2J-W10MA

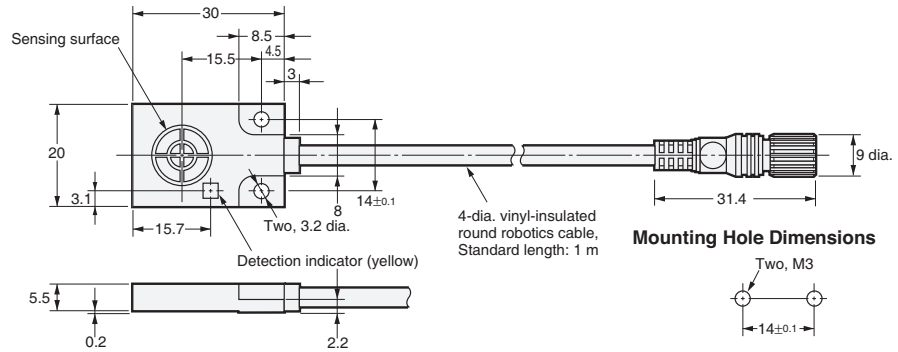
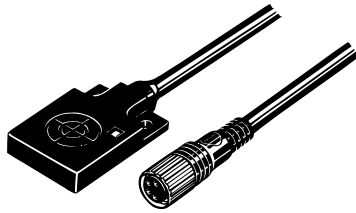

E2J-W20MA

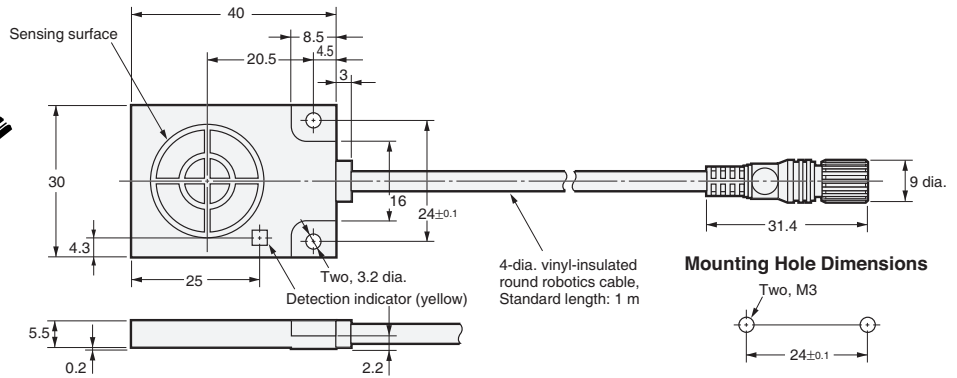
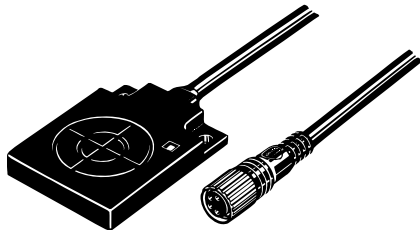

Amplifier Units

E2J-JC4A

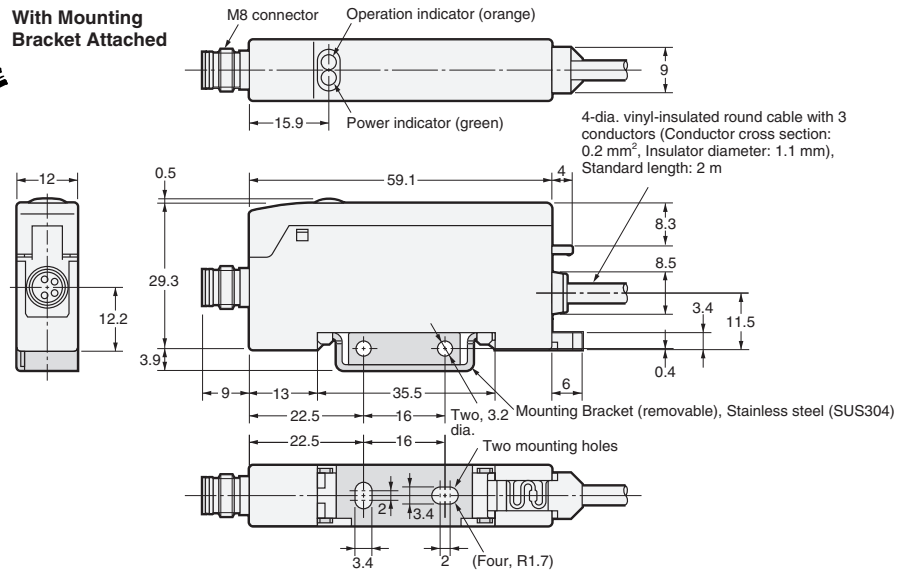
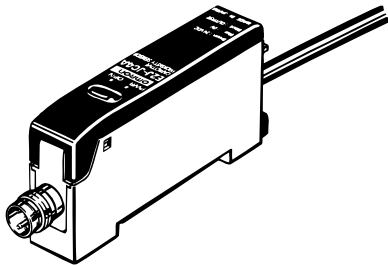

Accessories (Order Separately)

Dust Cover

Material: polyvinyl chloride (red)

XS3Z-13 (for E2J-JC4A Amplifier Unit)

XS3Z-15 (for E2J-W□MA Sensor)

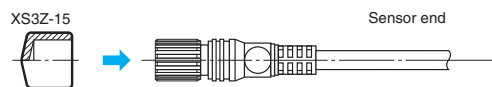
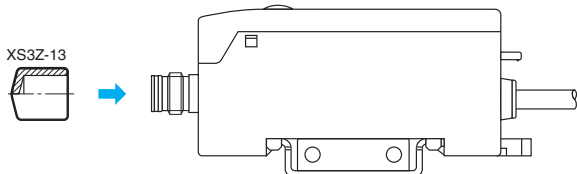

Terms and Conditions Agreement

Read and understand this catalog.

Please read and understand this catalog before purchasing the products. Please consult your OMRON representative if you have any questions or comments.

Warranties.

(a) Exclusive Warranty. Omron's exclusive warranty is that the Products will be free from defects in materials and workmanship for a period of twelve months from the date of sale by Omron (or such other period expressed in writing by Omron). Omron disclaims all other warranties, express or implied.

(b) Limitations. OMRON MAKES NO WARRANTY OR REPRESENTATION, EXPRESS OR IMPLIED, ABOUT NON-INFRINGEMENT, MERCHANTABILITY OR FITNESS FOR A PARTICULAR PURPOSE OF THE PRODUCTS. BUYER ACKNOWLEDGES THAT IT ALONE HAS DETERMINED THAT THE PRODUCTS WILL SUITABLY MEET THE REQUIREMENTS OF THEIR INTENDED USE.

Omron further disclaims all warranties and responsibility of any type for claims or expenses based on infringement by the Products or otherwise of any intellectual property right. (c) Buyer Remedy. Omron's sole obligation hereunder shall be, at Omron's election, to (i) replace (in the form originally shipped with Buyer responsible for labor charges for removal or replacement thereof) the non-complying Product, (ii) repair the non-complying Product, or (iii) repay or credit Buyer an amount equal to the purchase price of the non-complying Product; provided that in no event shall Omron be responsible for warranty, repair, indemnity or any other claims or expenses regarding the Products unless Omron's analysis confirms that the Products were properly handled, stored, installed and maintained and not subject to contamination, abuse, misuse or inappropriate modification. Return of any Products by Buyer must be approved in writing by Omron before shipment. Omron Companies shall not be liable for the suitability or unsuitability or the results from the use of Products in combination with any electrical or electronic components, circuits, system assemblies or any other materials or substances or environments. Any advice, recommendations or information given orally or in writing, are not to be construed as an amendment or addition to the above warranty.

See <http://www.omron.com/global/> or contact your Omron representative for published information.

Limitation on Liability: Etc.

OMRON COMPANIES SHALL NOT BE LIABLE FOR SPECIAL, INDIRECT, INCIDENTAL, OR CONSEQUENTIAL DAMAGES, LOSS OF PROFITS OR PRODUCTION OR COMMERCIAL LOSS IN ANY WAY CONNECTED WITH THE PRODUCTS, WHETHER SUCH CLAIM IS BASED IN CONTRACT, WARRANTY, NEGLIGENCE OR STRICT LIABILITY.

Further, in no event shall liability of Omron Companies exceed the individual price of the Product on which liability is asserted.

Suitability of Use.

Omron Companies shall not be responsible for conformity with any standards, codes or regulations which apply to the combination of the Product in the Buyer's application or use of the Product. At Buyer's request, Omron will provide applicable third party certification documents identifying ratings and limitations of use which apply to the Product. This information by itself is not sufficient for a complete determination of the suitability of the Product in combination with the end product, machine, system, or other application or use. Buyer shall be solely responsible for determining appropriateness of the particular Product with respect to Buyer's application, product or system. Buyer shall take application responsibility in all cases.

NEVER USE THE PRODUCT FOR AN APPLICATION INVOLVING SERIOUS RISK TO LIFE OR PROPERTY OR IN LARGE QUANTITIES WITHOUT ENSURING THAT THE SYSTEM AS A WHOLE HAS BEEN DESIGNED TO ADDRESS THE RISKS, AND THAT THE OMRON PRODUCT(S) IS PROPERLY RATED AND INSTALLED FOR THE INTENDED USE WITHIN THE OVERALL EQUIPMENT OR SYSTEM.

Programmable Products.

Omron Companies shall not be responsible for the user's programming of a programmable Product, or any consequence thereof.

Performance Data.

Data presented in Omron Company websites, catalogs and other materials is provided as a guide for the user in determining suitability and does not constitute a warranty. It may represent the result of Omron's test conditions, and the user must correlate it to actual application requirements. Actual performance is subject to the Omron's Warranty and Limitations of Liability.

Change in Specifications.

Product specifications and accessories may be changed at any time based on improvements and other reasons. It is our practice to change part numbers when published ratings or features are changed, or when significant construction changes are made. However, some specifications of the Product may be changed without any notice. When in doubt, special part numbers may be assigned to fix or establish key specifications for your application. Please consult with your Omron's representative at any time to confirm actual specifications of purchased Product.

Errors and Omissions.

Information presented by Omron Companies has been checked and is believed to be accurate; however, no responsibility is assumed for clerical, typographical or proofreading errors or omissions.