

Machine Automation Controller

NJ-Series

Controller that covers functions and high-speed processing required for machine control and safety, reliability and maintainability



Features

- Implemented OPC UA as standard feature.  OPC UA (NJ501-1□□0)
- Integration of Logic and Motion in one CPU.
- Conforms to IEC 61131-3 (JIS B 3503) standard programming and PLCopen function blocks for Motion Control. Programming with variables allows users to create complex programs efficiently.
- Fast and accurate control by synchronizing all EtherCAT devices, such as vision sensors, servo drives, and field devices, with the PLC and Motion Engines.
- Offers speed without compromising on reliability and robustness expected from PLCs.
- Complete RAS functions: Transmission frame error check, timeout, bus diagnosis, Watchdog (WDT), memory check, and topology check, etc.
- Ideal for small-scale control with up to 8 axes. (NJ301-□□□□)
- Ideal for simple machines. (NJ101-□□□□)
- Linear and circular interpolation.
- Electronic gear and cam synchronization.
- The Controller can be directly connected to a database. No special Unit, software, nor middleware is required. (NJ501-□□20/NJ101-□□20)
- The NJ501 SECS/GEM CPU Unit has built-in the SECS/GEM communications functions which are the standards in the semiconductor industry. (NJ501-1340)
- Control function of parallel link robots, cartesian robots and serial link robots. (NJ501-4□□0)
- Integration of Logic, Motion, OMRON Robot and Kinematics in one CPU. (NJ501-R□□0)
- Realize high-accuracy synchronization motion control (MC) and numerical control (NC) functions by ONE controller. G-Code available. (NJ501-5300)

NJ-Series

System Configuration

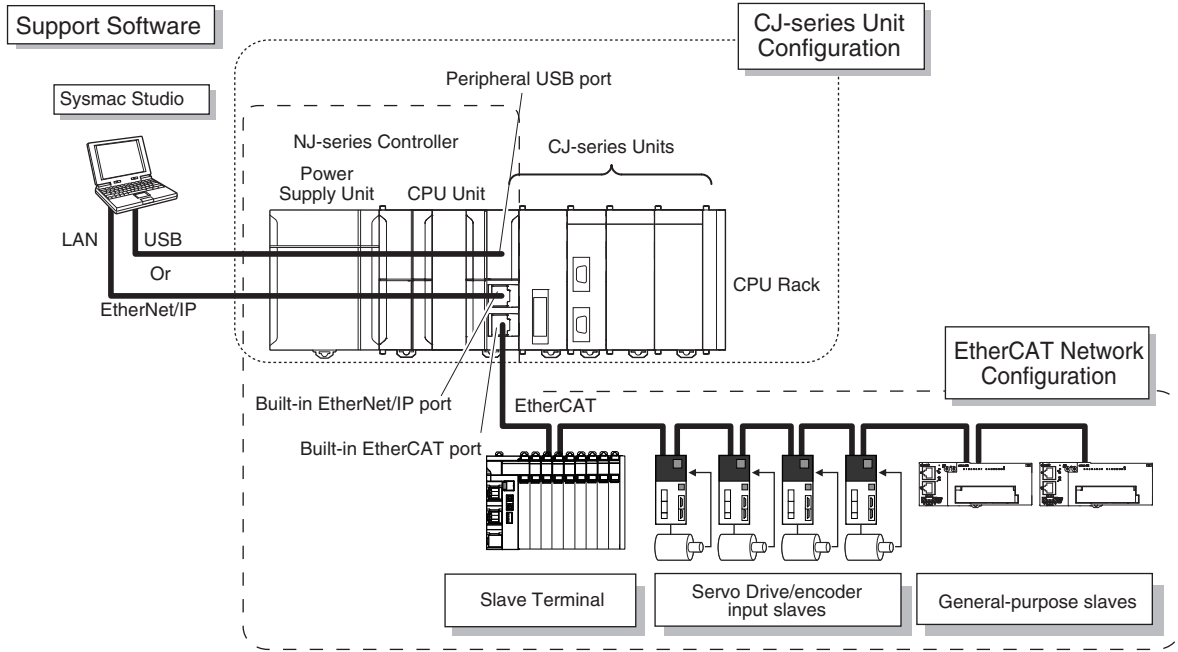

Ordering Information

Applicable standards

Refer to the OMRON website (www.ia.omron.com) or ask your OMRON representative for the most recent applicable standards for each model.

CPU Units

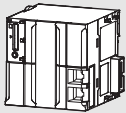
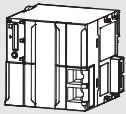
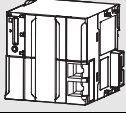
Product name	Specifications				Model
	I/O capacity / maximum number of configuration Units (Expansion Racks)	Program capacity	Memory capacity for variables	Number of motion axes	
NJ501 CPU Units  OPC UA Support	2,560 points / 40 Units (3 Expansion Racks)	20 MB	2 MB: Retained during power interruption 4 MB: Not retained during power interruption	64	NJ501-1500
				32	NJ501-1400
				16	NJ501-1300
NJ301 CPU Units 		5 MB	0.5 MB: Retained during power interruption 2 MB: Not retained during power interruption	8	NJ301-1200
				4	NJ301-1100
NJ101 CPU Units 		3 MB		2	NJ101-1000
	0			NJ101-9000	

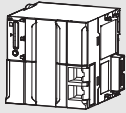
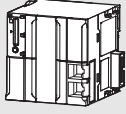
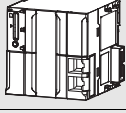
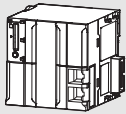
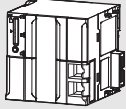
Product name	Specifications									Model									
	I/O capacity / maximum number of configuration Units (Expansion Racks)	Program capacity	Memory capacity for variables	Number of motion axes	Number of CNC axes	Database Connection function	SECS/GEM Communication function	Number of controlled robots	Number of controlled OMRON robots										
Database Connection CPU Units 	2,560 points / 40 Units (3 Expansion Racks)	20 MB	2 MB: Retained during power interruption 4 MB: Not retained during power interruption	64	0	Yes	No	---	---	NJ501-1520									
				32						NJ501-1420									
				16						NJ501-1320									
		3 MB	0.5 MB: Retained during power interruption 2 MB: Not retained during power interruption	2						NJ101-1020									
				0						NJ101-9020									
SECS/GEM CPU Unit  NJ Robotics CPU Units  Robot Integrated CPU Units 	2,560 points / 40 Units (3 Expansion Racks)	20 MB	2 MB: Retained during power interruption 4 MB: Not retained during power interruption	16	0	No	Yes	---	---	NJ501-1340									
				64						8 max. *1	NJ501-4500								
											32	NJ501-4400							
				16						1	NJ501-4300								
											64	8 max. *1	8 max.	NJ501-4310					
				32						NJ501-4320									
										16	NJ501-R500								
				64							NJ501-R520								
				32						NJ501-R400									
				16						NJ501-R420									
				NC Integrated Controller 									16	16 *2 *3	No				NJ501-5300

*1. The number of controlled robots varies according to the number of axes used for the system.
 *2. With a combination of a CPU Unit with CNC version 1.03 or higher and Sysmac Studio version 1.60 or higher, up to 32 axes can be controlled. For a CPU Unit with CNC version 1.02 or lower, the maximum number of motion axes and CNC axes total is 16 axes.
 *3. One CNC Operator License (SYSMAC-RTNC0001L) is attached with the CPU Unit.

NJ-Series

Accessories

The following accessories come with the CPU Unit.

Product name	Model
Battery	CJ1W-BAT01
End Cover	CJ1W-TER01 (must be attached to the right end of the CPU Rack)
End Plate	PFP-M (2 required)
SD Memory Card (Flash Memory)	NJ501-□□20, NJ501-1340, NJ501-R□□□: HMC-SD492 NJ101-□□20: HMC-SD292

Power Supply Units

One Power Supply Unit is required for each Rack.

Product name	Power supply voltage	Output current		Output capacity Total power consumption	Options			Model
		5-VDC output capacity	24-VDC output capacity		24-VDC service power supply	RUN output	Maintenance forecast monitor	
AC Power Supply Unit	100 to 240 VAC	6.0 A	1.0 A	30 W	No	Yes	No	NJ-PA3001
DC Power Supply Unit	24 VDC							NJ-PD3001

Note: Power supply units for the CJ-Series cannot be used as a power supply for a CPU rack of the NJ system or as a power supply for an expansion rack.

Expansion Racks

Select the I/O Control Unit, I/O Interface Unit, Expansion Connecting Cable, and Power Supply Unit.

CJ-Series I/O Control Unit (Mounted on CPU Rack when Connecting Expansion Racks)

Product name	Specifications	Current consumption (A)		Model
		5 V	24 V	
 CJ-Series I/O Control Unit	Mount one I/O Control Unit on the CJ-Series CPU Rack when connecting one NJ-Series Expansion Racks. Connecting Cable: CS1W-CN□□3 Expansion Connecting Cable Connected Unit: CJ1W-II101 I/O Interface Unit Mount to the right of the CPU Unit.	0.02	---	CJ1W-IC101

Note: Mounting the I/O Control Unit in any other location may cause faulty operation.

CJ-Series I/O Interface Unit (Mounted on Expansion Rack)

Product Name	Specifications	Current consumption (A)		Model
		5 V	24 V	
 CJ-Series I/O Interface Unit	One I/O Interface Unit is required on each Expansion Rack. Connecting Cable: CS1W-CN□□3 Expansion Connecting Cable Mount to the right of the Power Supply Unit.	0.13	---	CJ1W-II101

Note: Mounting the I/O Interface Unit in any other location may cause faulty operation.

I/O Connecting Cables

Product name	Specifications	Model
 I/O Connecting Cable	<ul style="list-style-type: none"> Connects an I/O Control Unit on NJ-Series CPU Rack to an I/O Interface Unit on a NJ-Series Expansion Rack. or Connects an I/O Interface Unit on NJ-Series Expansion Rack to an I/O Interface Unit on another NJ-Series Expansion Rack. 	Cable length: 0.3 m
		Cable length: 0.7 m
		Cable length: 2 m
		Cable length: 3 m
		Cable length: 5 m
		Cable length: 10 m
		Cable length: 12 m
		CS1W-CN313
		CS1W-CN713
		CS1W-CN223
		CS1W-CN323
		CS1W-CN523
		CS1W-CN133
		CS1W-CN133-B2

Automation Software Sysmac Studio

The Sysmac Studio is the software that provides an integrated environment for setting, programming, debugging and maintenance of machine automation controllers including the NJ/NX-series CPU Units, NY-series Industrial PC, EtherCAT Slave, and the HMI.

For details, refer to your local OMRON website and Sysmac Studio Catalog (Cat. No. P138).

Collection of software functional components Sysmac Library

Please download it from following URL and install to Sysmac Studio.

https://www.ia.omron.com/sysmac_library/

Typical Models

Product	Features	Model
Vibration Suppression Library	The Vibration Suppression Library is used to suppress residual vibration caused by the operation of machines.	SYSMAC-XR006
Device Operation Monitor Library	The Device Operation Monitor Library is used to monitor the operation of devices such as air cylinders, sensors, motors, and other devices.	SYSMAC-XR008
Dimension Measurement Library	The Dimension Measurement Library is used to dimension measurement with ZW-8000/7000/5000 Confocal Fiber Displacement Sensor, or E9NC-TA0 Contact-Type Smart Sensor.	SYSMAC-XR014

SECS/GEM Configurator (For NJ-series SECS/GEM CPU Unit NJ501-1340)

Please purchase the required number of SECS/GEM Configurator licenses and a Sysmac Studio Standard Edition DVD the first time you purchase the SECS/GEM Configurator.

The Sysmac Studio Standard Edition DVD includes the SECS/GEM Configurator. The license does not include the DVD.

Product Name	Specifications	Specifications		Model
		Number of licenses	Media	
SECS/GEM Configurator Ver.1.□□	The SECS/GEM Configurator is the software to make HSMS, SECSII and GEM settings for NJ501 SECS/GEM CPU Units. The software is included in the Sysmac Studio Standard Edition DVD.	1 license	---	WS02-GCTL1

Operation Software CNC Operator (For NJ-series NC Integrated Controller NJ501-5300)

Please purchase a DVD or download it from following URL.

<http://www.ia.omron.com/cnc-operator/>

One CNC Operator License (SYSMAC-RTNC0001L) is attached with the CPU Unit.

Product Name	Specifications	Specifications		Model
		Number of licenses	Media	
CNC Operator	The CNC Operator is the software that provides a operation interface for NC programming, debugging and maintenance of CNC machine.	--- (Installer only)	--- (Download)	SYSMAC-RTNC0000
		--- (Media only)	DVD	SYSMAC-RTNC0000D
CNC Operator License	The one license key (hardware key, USB dongle). The CNC Operator needs license key.	1 license	---	SYSMAC-RTNC0001L
CNC Operator Software Development Kit	The CNC Operator Software Development Kit provides a environment for customization of CNC Operator. Supported execution environment: NET Framework (4.6.1) Development environment: Visual Studio 2013/2015 Development languages: C#	---	DVD	SYSMAC-RTNC0101D

Recommended EtherCAT and EtherNet/IP Communications Cables





Use a straight STP (shielded twisted-pair) cable of category 5 or higher with double shielding (aluminum tape and braiding) for EtherCAT.

For EtherNet/IP, required specification for the communications cables varies depending on the baud rate.

For 100BASE-TX/10BASE-T, use a straight or cross STP (shielded twisted-pair) cable of category 5 or higher.

For 1000BASE-T, use a straight or cross STP cable of category 5e or higher with double shielding (aluminum tape and braiding).

Cable with Connectors

Item		Recommended manufacturer	Cable length (m)	Model
Wire Gauge and Number of Pairs: AWG26, 4-pair Cable Cable Sheath material: PUR	Cable with Connectors on Both Ends (RJ45/RJ45) Standard RJ45 plug type *1 Cable color: Yellow *2 EtherCAT/ EtherNet/IP (10BASE/100BASE/1000BASE *4) 	OMRON	0.3	XS6W-6PUR8SS30CM-YF
			0.5	XS6W-6PUR8SS50CM-YF
			1	XS6W-6PUR8SS100CM-YF
			2	XS6W-6PUR8SS200CM-YF
			3	XS6W-6PUR8SS300CM-YF
			5	XS6W-6PUR8SS500CM-YF
Wire Gauge and Number of Pairs: AWG22, 2-pair cable	Cable with Connectors on Both Ends (RJ45/RJ45) Rugged RJ45 plug type *1 Cable color: Light blue EtherCAT/ EtherNet/IP (10BASE/100BASE) 	OMRON	0.3	XS5W-T421-AMD-K
			0.5	XS5W-T421-BMD-K
			1	XS5W-T421-CMD-K
			2	XS5W-T421-DMD-K
			5	XS5W-T421-GMD-K
	Cable with Connectors on Both Ends (M12 Straight/M12 Straight) Shield Strengthening Connector cable *3 M12/Smartclick Connectors Cable color: Black EtherCAT/ EtherNet/IP (10BASE/100BASE) 	OMRON	0.5	XS5W-T421-BM2-SS
			1	XS5W-T421-CM2-SS
			2	XS5W-T421-DM2-SS
			3	XS5W-T421-EM2-SS
			5	XS5W-T421-GM2-SS
	Cable with Connectors on Both Ends (M12 Straight/RJ45) Shield Strengthening Connector cable *3 M12/Smartclick Connectors Rugged RJ45 plug type Cable color: Black EtherCAT/ EtherNet/IP (10BASE/100BASE) 	OMRON	0.5	XS5W-T421-BMC-SS
			1	XS5W-T421-CMC-SS
2			XS5W-T421-DMC-SS	
3			XS5W-T421-EMC-SS	
5			XS5W-T421-GMC-SS	
		OMRON	10	XS5W-T421-JMD-K
			10	XS5W-T421-JM2-SS
			10	XS5W-T421-JMC-SS
			10	XS5W-T421-JMC-SS
			10	XS5W-T421-JMC-SS

*1. Cables with standard RJ45 plugs are available in the following lengths: 0.2 m, 0.3 m, 0.5 m, 1 m, 1.5 m, 2 m, 3 m, 5 m, 7.5 m, 10 m, 15 m, 20 m. Cables with rugged RJ45 plugs are available in the following lengths: 0.3 m, 0.5 m, 1 m, 2 m, 3 m, 5 m, 10 m, 15 m.

For details, refer to the *Industrial Ethernet Connectors Catalog* (Cat. No. G019).

*2. Cable colors are available in yellow, green, and blue.

*3. For details, contact your OMRON representative.

*4. The products can be used only with the NX701/NX502.

Cables / Connectors

Item		Recommended manufacturer	Model
Products for EtherCAT or EtherNet/IP (1000BASE-T*2/100BASE-TX)	Wire Gauge and Number of Pairs: AWG24, 4-pair Cable	Cables	Kuramo Electric Co. KETH-SB *1
		RJ45 Connectors	Panduit Corporation MPS588-C *1
Products for EtherCAT or EtherNet/IP (100BASE-TX/10BASE-T)	Wire Gauge and Number of Pairs: AWG22, 2-pair Cable	Cables	Kuramo Electric Co. KETH-PSB-OMR *3
			JMACS Japan Co., Ltd. PNET/B *3
		RJ45 Assembly Connector	OMRON  XS6G-T421-1 *3

*1. We recommend you to use the above Cable and RJ45 Connector together.



*2. The products can be used only with the NX701/NX502.

*3. We recommend you to use the above Cable and RJ45 Assembly Connector together.



Optional Products and Maintenance Products

Product name	Specifications	Model
Memory Cards *1	SD memory card, 2GB	HMC-SD292
	SDHC memory card, 4GB	HMC-SD492
	SDHC memory card, 16GB	HMC-SD1A2



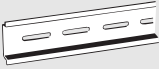

*1. There are restrictions on the combination of CPU Unit version and memory card. Refer to NJ/NX-series CPU Unit Software User's Manual (W501) 8-5-2 *Specifications of Supported SD Memory Cards, Folders, and Files* for details.

Product name	Specifications	Model
Battery Set 	Battery for NX701-□□□□/NJ501-□□□□/ NJ301-□□□□/NJ101-□□□□ NJ/NX-Series CPU Unit maintenance	CJ1W-BAT01 Note: 1. The battery is included as a standard accessory with the CPU Unit. 2. The battery service life is 5 years at 25°C. (The service life depends on the ambient operating temperature and the power conditions.) 3. Use batteries within two years of manufacture.
End Cover 	Mounted to the right-hand side of NJ-Series CPU Racks or Expansion Racks.	One End Cover is provided as a standard accessory with each CPU Unit and I/O Interface Unit. CJ1W-TER01

DIN Track Accessories

Product name	Specifications	Model
DIN Track 	Length: 0.5 m; Height: 7.3 mm	PFP-50N
	Length: 1 m; Height: 7.3 mm	PFP-100N
	Length: 1 m; Height: 16 mm	PFP-100N2
End Plate 	There are 2 stoppers provided with CPU Units and I/O Interface Units as standard accessories to secure the Units on the DIN Track.	PFP-M

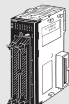



Basic I/O Units
Input Units

Unit classification	Product name	Specifications				Number of bits allocated	Response time *1		Current consumption (A)		Model
		I/O points	Input voltage and current	Commons	External connection		ON	OFF	5 V	24 V	
CJ1 Basic I/O Units	DC Input Units   	8 inputs	12 to 24 VDC, 10 mA	Independent contacts	Removable terminal block	16	20 μs max.	400 μs max.	0.08	---	CJ1W-ID201
		16 inputs	24 VDC, 7 mA	16 points, 1 common	Removable terminal block	16	20 μs max.	400 μs max.	0.08	---	CJ1W-ID211
		16 inputs <i>High-speed type</i>	24 VDC, 7 mA	16 points, 1 common	Removable terminal block	16	15 μs max.	90 μs max.	0.13	---	CJ1W-ID212
		32 inputs	24 VDC, 4.1 mA	16 points, 1 common	Fujitsu/OTAX connector	32	20 μs max.	400 μs max.	0.09	---	CJ1W-ID231 *2
		32 inputs	24 VDC, 4.1 mA	16 points, 1 common	MIL connector	32	20 μs max.	400 μs max.	0.09	---	CJ1W-ID232 *2
		32 inputs <i>High-speed type</i>	24 VDC, 4.1 mA	16 points, 1 common	MIL connector	32	15 μs max.	90 μs max.	0.20	---	CJ1W-ID233 *2
		64 inputs	24 VDC, 4.1 mA	16 points, 1 common	Fujitsu/OTAX connector	64	120 μs max.	400 μs max.	0.09	---	CJ1W-ID261 *2
	64 inputs	24 VDC, 4.1 mA	16 points, 1 common	MIL connector	64	120 μs max.	400 μs max.	0.09	---	CJ1W-ID262 *2	
	AC Input Units 	8 inputs	200 to 24 VAC, 10 mA (200 V, 50 Hz)	8 points, 1 common	Removable Terminal Block	16	10 μs max.	40 μs max.	0.08	---	CJ1W-IA201
		16 inputs	100 to 120 VAC, 7 mA (100 V, 50 Hz)	16 points, 1 common	Removable Terminal Block	16	10 μs max.	40 μs max.	0.09	---	CJ1W-IA111

*1 This is the input response time when no filter (i.e., 0 ms) is set.

*2 The cable-side connector is not provided with Units equipped with cables. Purchase the 40-pin connector separately (Refer to page 11), or use an OMRON XW2K Series Datasheet (Cat. No. G152) and XW2R Datasheet or a G7□ I/O Relay Terminal.

Output Units

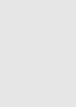
Unit classification	Product name	Specifications					Number of bits allocated	Current consumption (A)		Model
		Output type	I/O points	Maximum switching capacity	Commons	External connection		5 V	24 V	
CJ1 Basic I/O Units	Relay Contact Output Units 	–	8 outputs	250 VAC/24 VDC, 2 A	Independent contacts	Removable terminal block	16	0.09	0.048 max.	CJ1W-OC201
		–	16 outputs	250 VAC/24 VDC, 2 A	16 points, 1 common	Removable terminal block	16	0.11	0.096 max.	CJ1W-OC211
	Triac Output Unit 	–	8 outputs	250 VAC, 0.6 A	8 points, 1 common	Removable terminal block	16	0.22	–	CJ1W-OA201 *1 CJ1W-OA201-1
	Transistor Output Units    	Sinking	8 outputs	12 to 24 VDC, 2 A	4 points, 1 common	Removable terminal block	16	0.09	–	CJ1W-OD201
		Sinking	8 outputs	12 to 24 VDC, 0.5 A	8 points, 1 common	Removable terminal block	16	0.10	–	CJ1W-OD203
		Sinking	16 outputs	12 to 24 VDC, 0.5 A	16 points, 1 common	Removable terminal block	16	0.10	–	CJ1W-OD211 *2
		Sinking	16 outputs <small>High-speed type</small>	24 VDC, 0.5 A	16 points, 1 common	Removable terminal block	16	0.15	–	CJ1W-OD213 *2
		Sinking	32 outputs	12 to 24 VDC, 0.5 A	16 points, 1 common	Fujitsu/OTAX connector	32	0.14	–	CJ1W-OD231 *3
		Sinking	32 outputs	12 to 24 VDC, 0.5 A	16 points, 1 common	MIL connector	32	0.14	–	CJ1W-OD233 *2, *3
		Sinking	32 outputs <small>High-speed type</small>	24 VDC, 0.5 A	16 points, 1 common	MIL connector	32	0.22	–	CJ1W-OD234 *2, *3
		Sinking	64 outputs	12 to 24 VDC, 0.3 A	16 points, 1 common	Fujitsu/OTAX connector	64	0.17	–	CJ1W-OD261 *3
		Sinking	64 outputs	12 to 24 VDC, 0.3 A	16 points, 1 common	MIL connector	64	0.17	–	CJ1W-OD263 *3
		Sourcing	8 outputs	24 VDC, 2 A Short-circuit protection	4 points, 1 common	Removable terminal block	16 *1	0.11	–	CJ1W-OD202
		Sourcing	8 outputs	24 VDC, 0.5 A Short-circuit protection	8 points, 1 common	Removable terminal block	16 *1	0.10	–	CJ1W-OD204
		Sourcing	16 outputs	24 VDC, 0.5 A Short-circuit protection	16 points, 1 common	Removable terminal block	16	0.10	–	CJ1W-OD212
Sourcing		32 outputs	24 VDC, 0.5 A Short-circuit protection	16 points, 1 common	MIL connector	32	0.15	–	CJ1W-OD232 *3	
Sourcing	64 outputs	12 to 24 VDC, 0.3 A	16 points, 1 common	MIL connector	64	0.17	–	CJ1W-OD262 *3		

*1 CJ1W-OA201 is not UC1 cULus (Class I Division 2 hazardous location certification). If cULus (Class I Div 2 hazardous location certification) is required, use CJ1W-OA201-1.

*2 The ON/OFF response time for the CJ1W-OD213/CJ1W-OD234 is shorter than for the CJ1W-OD211/CJ1W-OD233, as shown below.

- ON response time: 0.1 ms improved to 0.015 ms
- OFF response time: 0.8 ms improved to 0.08 ms

*3 Connectors are not provided with these connector models. Either purchase one of the following 40-pin Connectors, or use an OMRON XW2K Series Datasheet (Cat. No. G152) and XW2R Datasheet or a G7□ I/O Relay Terminal.

I/O Units

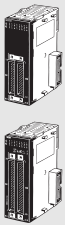
Unit classification	Product name	Specifications					Number of bits allocated	Current consumption (A)		Model
		Output type	I/O points	Input voltage, Input current	Commons	External connection		5 V	24 V	
				Maximum switching capacity						
CJ1 Basic I/O Units	 DC Input/Transistor Output Units	Sinking	16 inputs	24 VDC, 7 mA	16 points, 1 common	Fujitsu/OTAX connector	32	0.13	---	CJ1W-MD231 *2
			16 outputs	250 VAC/24 VDC, 0.5 A	16 points, 1 common					
		Sinking	16 inputs	24 VDC, 7 mA	16 points, 1 common	MIL connector	64	0.13	---	CJ1W-MD233 *2
			16 outputs	12 to 24 VDC, 0.5 A	16 points, 1 common					
		Sinking	32 inputs	24 VDC, 4.1 mA	16 points, 1 common	Fujitsu/OTAX connector	32	0.14	---	CJ1W-MD261 *1
			32 outputs	12 to 24 VDC, 0.3 A	16 points, 1 common					
	Sinking	32 inputs	24 VDC, 4.1 mA	16 points, 1 common	MIL connector	64	0.14	---	CJ1W-MD263 *1	
		32 outputs	12 to 24 VDC, 0.3 A	16 points, 1 common						
	Sourcing	16 inputs	24 VDC, 7 mA	16 points, 1 common	MIL connector	32	0.13	---	CJ1W-MD232 *2	
		16 outputs	24 VDC, 0.5 A Short-circuit protection	16 points, 1 common						
	TTL I/O Units	---	32 inputs	5 VDC, 35 mA	16 points, 1 common	MIL connector	64	0.19	---	CJ1W-MD563 *1
			32 outputs	5 VDC, 35 mA	16 points, 1 common					

*1 Connectors are not provided with these connector models. Either purchase one of the following 40-pin Connectors, or use an OMRON XW2K Series Datasheet (Cat. No. G152) and XW2R Datasheet or a G7□ I/O Relay Terminal.

*2 Connectors are not provided with these connector models. Either purchase one of the following 20-pin or 24-pin Connectors, or use an OMRON XW2K Series Datasheet (Cat. No. G152) and XW2R Datasheet or a G7□ I/O Relay Terminal.

Applicable Connectors

Fujitsu/OTAX Connectors for 32-input, 32-output, 64-input, 64-output, 32-input/32-output, and 16-input/16-output Units

Name	Connection	Remarks	Applicable Units	Model
40-pin Connectors	Soldered	Connector Fujitsu FCN-361J040-AU Connector Cover Fujitsu FCN-360C040-J2 OTAX N360C040J2	Fujitsu/OTAX Connectors: CJ1W-ID231 (32 inputs): 1 per Unit CJ1W-ID261 (64 inputs) 2 per Unit CJ1W-OD231 (32 outputs): 1 per Unit CJ1W-OD261 (64 outputs): 2 per Unit CJ1W-MD261 (32 inputs, 32 outputs): 2 per Unit	C500-CE404
	Crimped	Housing Fujitsu FCN-363J040 OTAX N363J040 Contactor Fujitsu FCN-363J-AU OTAX N363JAU Connector Cover Fujitsu FCN-360C040-J2 OTAX N360C040J2		C500-CE405
	Pressure welded	Fujitsu FCN-367J040-AU/F		C500-CE403
24-pin Connectors	Soldered	Connector Fujitsu FCN-361J024-AU Connector Cover Fujitsu FCN-360C024-J2 OTAX N360C024J2	Fujitsu/OTAX Connectors: CJ1W-MD231 (16 inputs, 16 outputs): 2 per Unit	C500-CE241
	Pressure welded	Fujitsu FCN-367J024-AU/F OTAX N367J024AUF		C500-CE243

MIL Connectors for 32-input, 32-output, 64-input, 64-output, 32-input/32-output, and 16-input/16-output Units

Name	Connection	Remarks	Applicable Units	Model
40-pin Connectors	Pressure welded	FRC5-AO40-3TOS	MIL Connectors: CJ1W-ID232/233 (32 inputs): 1 per Unit CJ1W-OD232/233/234 (32 outputs): 1 per Unit CJ1W-ID262 (64 inputs): 2 per Unit CJ1W-OD262/263 (64 outputs): 2 per Unit CJ1W-MD263/563 (32 inputs, 32 outputs): 2 per Unit	XG4M-4030-T
20-pin Connectors	Pressure welded	FRC5-AO20-3TOS	MIL Connectors: CJ1W-MD232/233 (16 inputs, 16 outputs): 2 per Unit	XG4M-2030-T

Applicable Connector-terminal block conversion unit

Example: With OMRON Connector-terminal block conversion unit

Only main products are shown here.

More detail informations are shown in *XW2K Series Datasheet* (Cat. No. G152) and *XW2R Datasheet*.

32-point Input Unit or Output Unit CJ1W-ID231 32-point

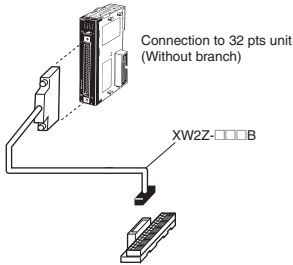

64-point Input Unit or Output Unit CJ1W-ID261 64-point

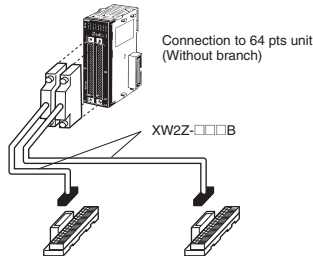

64-point Output Unit CJ1W-MD563 IN 32 Points, OUT 32 Points

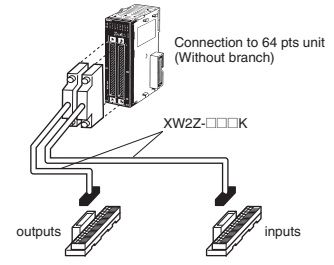

Choose the wiring method.

Choose □□ from a following combination table PLC type.

Wiring method	Model
Models with Push-In Plus	XW2K-40G-032□
Models with Phillips screw	XW2R-J34GD-C□
Models with Slotted screw (rise up)	XW2R-E34GD-C□



Combination table

PLC Type (Connector-terminal block)		PLC			Connecting cables
XW2K	XW2R	I/O	I/O Points	I/O unit model	
O32A	C1	Input	32	CJ1W-ID231	XW2Z-□□□B 32-point Unit: 1 Cable 64-point Unit: 2 Cables
			64	CJ1W-ID261	
		Input/Output	32	CJ1W-MD261 (inputs)	
		Input	32	CJ1W-ID232	XW2Z-□□□K 32-point Unit: 1 Cable 64-point Unit: 2 Cables
CJ1W-ID233					
O32C	C2	Input	64	CJ1W-ID262	
			32	CJ1W-MD263 (inputs)	
		Input/Output	32	CJ1W-MD563 (inputs)	
		Input	32	CJ1W-OD231	XW2Z-□□□B 32-point Unit: 1 Cable 64-point Unit: 2 Cables
64	CJ1W-OD261				
O32B	C3	Input/Output	32	CJ1W-MD261 (outputs)	
			Output	32	CJ1W-OD232
CJ1W-OD233					
O32C	C4	Output	64	CJ1W-OD234	
			32	CJ1W-OD262	
		Input/Output	64	CJ1W-OD263	
			32	CJ1W-MD263 (outputs)	
			32	CJ1W-MD563 (outputs)	

Note: 1. □□□ is replaced by the cable length.

2. There is one common for each 32 points.

Connector-terminal block conversion unit

Product name	Specifications	I/O Points (number of poles)	Model
Connector-Terminal Block Conversion Unit	Push-In Plus 	32 (36)	XW2K-40G-O32A
		32 (36)	XW2K-40G-O32B
		32 (36)	XW2K-40G-O32C
	Phillips screw 	32 (34)	XW2R-J34GD-C1
		32 (34)	XW2R-J34GD-C2
		32 (34)	XW2R-J34GD-C3
		32 (34)	XW2R-J34GD-C4
	Slotted screw (rise up) 	32 (34)	XW2R-E34GD-C1
		32 (34)	XW2R-E34GD-C2
		32 (34)	XW2R-E34GD-C3
		32 (34)	XW2R-E34GD-C4

Connecting cables

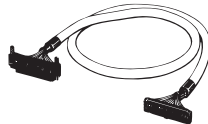
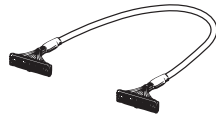
Product name	Appearance	Connectors	Model	Cable length (m)
For I/O Unit Connecting Cable	XW2Z-□□□B 	One 40-pin FCN Connector to One 40-pin MIL Connector	XW2Z-050B	0.5
			XW2Z-100B	1
			XW2Z-150B	1.5
			XW2Z-200B	2
			XW2Z-300B	3
			XW2Z-500B	5
	XW2Z-□□□K 	One 40-pin MIL Connector to One 40-pin MIL Connector	XW2Z-C50K	0.5
			XW2Z-100K	1
			XW2Z-150K	1.5
			XW2Z-200K	2
			XW2Z-300K	3
			XW2Z-500K	5

Quick-response Input Units

Unit classification	Product name	Specifications				Number of bits allocated	Response time		Current consumption (A)		Model
		I/O points	Input voltage, Input current	Commons	External connection		ON	OFF	5 V	24 V	
CJ1 Basic I/O Units	Quick-response Input Unit 	16 inputs	24 VDC, 7 mA	16 points, 1 common	Removable terminal block	16	0.05 ms max.	0.5 ms max.	0.08	---	CJ1W-IDP01

Special I/O Units and CPU Bus Units

Process I/O Units

Isolated-type Units with Universal Inputs

Unit classification	Product name	Input points	Signal range selection	Signal range	Conversion speed (resolution)	Accuracy (at ambient temperature of 25°C)	External connection	No. of unit numbers allocated	Current consumption (A)		Model
									5 V	24 V	
CJ1 Special I/O Units	Process Input Units (Isolated-type Units with Universal Inputs) 	4 inputs	Set separately for each input	Universal inputs: Pt100 (3-wire), JPt100 (3-wire), Pt1000 (3-wire), Pt100 (4-wire), K, J, T, E, L, U, N, R, S, B, WRe5-26, PL II, 4 to 20 mA, 0 to 20 mA, 1 to 5 V, 0 to 1.25 V, 0 to 5 V, 0 to 10 V, ±100 mV selectable range -1.25 to 1.25 V, -5 to 5 V, -10 to 10 V, ±10 V selectable range, potentiometer	Resolution (conversion speed): 1/256,000 (conversion cycle: 60 ms/4 inputs) 1/64,000 (conversion cycle: 10 ms/4 inputs) 1/16,000 (conversion cycle: 5 ms/4 inputs)	Standard accuracy: ±0.05% of F.S.	Removable terminal block	1	0.30	---	CJ1W-PH41U *1
		4 inputs	Set separately for each input	Universal inputs: Pt100, JPt100, Pt1000, K, J, T, L, R, S, B, 4 to 20 mA, 0 to 20 mA, 1 to 5 V, 0 to 5 V, 0 to 10 V	Conversion speed: 250 ms/4 inputs				Accuracy: Platinum resistance thermometer input: (±0.3% of PV or ±0.8°C, whichever is larger) ±1 digit max. Thermocouple input: (±0.3% of PV or ±1.5°C, whichever is larger) ±1 digit max. *2 Voltage or current input: ±0.3% of F.S. ±1 digit max.	0.32	---

*1 Do not connect a Relay Output Unit to the same CPU Rack or to the same Expansion Rack as the CJ1W-PH41U.

*2 L and -100°C or less for K and T are ±2°C±1 digit max., and 200°C or less for R and S is ±3°C±1 digit max. No accuracy is specified for 400°C or less for B.



Isolated-type DC Input Units

Unit classification	Product name	Input points	Signal range selection	Conversion speed (resolution)	Accuracy (at ambient temperature of 25°C)	External connection	No. of unit numbers allocated	Current consumption (A)		Model
								5 V	24 V	
CJ1 Special I/O Units	Isolated-type DC Input Units 	2 inputs	DC voltage: 0 to 1.25 V, -1.25 to 1.25 V, 0 to 5 V, 1 to 5 V, -5 to 5 V, 0 to 10 V, -10 to 10 V, ±10 V selectable range DC current: 0 to 20 mA, 4 to 20 mA	Conversion speed: 10 ms/2 inputs Resolution: 1/64,000	Standard accuracy: ±0.05% of F.S.	Removable terminal block	1	0.18	0.09 *	CJ1W-PDC15

* This is for an external power supply, and not for internal current consumption.

Analog I/O Units

Analog Input Units



Unit classification	Product name	Input points	Signal range selection	Signal range	Resolution	Conversion speed	Accuracy (at ambient temperature of 25°C)	External connection	No. of unit numbers allocated	Current consumption (A)		Model
										5 V	24 V	
CJ1 Special I/O Units	Analog Input Units 	4 inputs	Set separately for each input	1 to 5 V (1/10,000), 0 to 10 V (1/20,000), -5 to 5 V (1/20,000), -10 to 10 V (1/40,000), and 4 to 20 mA (1/10,000)		20 μs/1 point, 25 μs/2 points, 30 μs/3 points, 35 μs/4 points	Voltage: ±0.2% of F.S. Current: ±0.4% of F.S.	Removable terminal block	1	0.52	---	CJ1W-AD042 *1
	Analog Input Units 	8 inputs		1 to 5 V, 0 to 5 V, 0 to 10 V, -10 to 10 V, 4 to 20 mA	1/4000, (Settable to 1/8000) *2	1 ms/point max. (Settable to 250 μs/point) *2	Voltage: ±0.2% of F.S. Current: ±0.4% of F.S. *3			0.42	---	CJ1W-AD081-V1
		4 inputs								0.42	---	CJ1W-AD041-V1

*1 The direct conversion function using the AIDC instruction cannot be used.

*2 The resolution and conversion speed cannot be set independently. If the resolution is set to 1/4,000, then the conversion speed will be 1 ms/point.

*3 At 23 ±2°C

Analog Output Units

Unit classification	Product name	Output points	Signal range selection	Signal range	Resolution	Conversion speed	Accuracy (at ambient temperature of 25°C)	External connection	External power supply	No. of unit numbers allocated	Current consumption (A)		Model
											5 V	24 V	
CJ1 Special I/O Units	Analog Output Units 	4 outputs	Set separately for each input	1 to 5 V (1/10,000), 0 to 10 V (1/20,000), and -10 to 10 V (1/40,000)		20 μs/1 point, 25 μs/2 points, 30 μs/3 points, 35 μs/4 points	±0.3% of F.S.	Removable terminal block	---	1	0.40	---	CJ1W-DA042V *1
	Analog Output Units 	8 outputs		1 to 5 V, 0 to 5 V, 0 to 10 V, -10 to 10 V	1/4,000 (Settable to 1/8,000)	1 ms/point max. (Settable to 250 μs/point)					24 VDC ^{+10%} _{-15%} , 140 mA max.	0.14	0.14 *2
		8 outputs		4 to 20 mA			24 VDC ^{+10%} _{-15%} , 170 mA max.		0.14		0.17 *2	CJ1W-DA08C	
		4 outputs		1 to 5 V, 0 to 5 V, 0 to 10 V, -10 to 10 V, 4 to 20 mA	1/4000	1 ms/point max.	24 VDC ^{+10%} _{-15%} , 200 mA max.		0.12		0.2 *2	CJ1W-DA041	
		2 outputs				24 VDC ^{+10%} _{-15%} , 140 mA max.	0.12	0.14 *2	CJ1W-DA021				

*1 The direct conversion function using the AODC instruction cannot be used.

*2 This is for an external power supply, and not for internal current consumption

Analog I/O Units

Unit classification	Product name	No. of points	Signal range selection	Signal range	Resolution (See note.)	Conversion speed (See note.)	Accuracy (at ambient temperature of 25°C)	External connection	No. of unit numbers allocated	Current consumption (A)		Model
										5 V	24 V	
CJ1 Special I/O Units	Analog I/O Units 	4 inputs	Set separately for each input	1 to 5 V, 0 to 5 V, 0 to 10 V, -10 to 10 V, 4 to 20 mA	1/4,000 (Settable to 1/8,000)	1 ms/point (Settable to 500 μs/point max.)	Voltage input: ±0.2% of F.S. Current input: ±0.2% of F.S.	Removable terminal block	1	0.58	---	CJ1W-MAD42
	2 outputs	Voltage output: ±0.3% of F.S. Current output: ±0.3% of F.S.										

Note: The resolution and conversion speed cannot be set independently. If the resolution is set to 1/4,000, then the conversion speed will be 1 ms/point.

Temperature Control Units

Unit classification	Product name	Specifications			No. of unit numbers allocated	Current consumption (A)		Model
		No. of loops	Temperature sensor inputs	Control outputs		5 V	24 V	
CJ1 Special I/O Units	Temperature Control Units 	2 loops, heater burnout detection function	Thermocouple input (R, S, K, J, T, B, L)	Open collector NPN outputs (pulses)	2	0.25	---	CJ1W-TC003
				Open collector PNP outputs (pulses)		0.25	---	CJ1W-TC004
			Platinum resistance thermometer input (JPt100, Pt100)	Open collector NPN outputs (pulses)		0.25	---	CJ1W-TC103
				Open collector PNP outputs (pulses)		0.25	---	CJ1W-TC104



High-speed Counter Unit

Unit classification	Product name	Specifications			No. of unit numbers allocated	Current consumption (A)		Model
		Countable channels	Encoder A and B inputs, pulse input Z signals	Max. counting rate		5 V	24 V	
CJ1 Special I/O Units	High-speed Counter Unit 	2	Open collector Input voltage: 5 VDC, 12 V, or 24 V (5 V and 12 V are each for one axis only.)	50 kHz	4	0.28	---	CJ1W-CT021
			RS-422 line driver	500 kHz				

Note: The following functions become unavailable when it is used with the NJ-Series CPU unit.

- Counter value capture using allocation area(CIO)
- The capture, Stop/capture/continue, Stop/capture/reset/continue, and Capture/reset functions using External Control Input Function
- Pulse rate range control using Output Control Mode
- The pulse rate measurement function
- Because the NJ-Series has no power OFF interrupt task, operation cannot be restarted from the position at which the power was interrupted.
- Read or write the data using IORD/IOWR instruction
- Starting of External Interrupt Task by Output and External Control Input

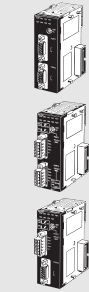
Serial Communications Units

Unit classification	Product name	Specifications		No. of unit numbers allocated	Current consumption (A)		Model
		Communications Interface	Communications functions		5 V	24 V	
CJ1 CPU Bus Units	Serial Communications Units High-speed type 	2 RS-232C ports	The following functions can be selected for each port: Protocol macro *1 Host Link NT Links (1:N mode) Serial Gateway No-protocol *3 Modbus-RTU Slave	1	0.29 *2	---	CJ1W-SCU22
		2 RS-422A/485 ports			0.46	---	CJ1W-SCU32
		1 RS-232C port and 1 RS-422A/485 port			0.38 *2	---	CJ1W-SCU42
RS-422A Converter		Converts RS-232C to RS-422A/RS-485.					CJ1W-CIF11

Note: Simple Backup Function and Interrupt notification function cannot be used.

*1 You can activate protocol macro trace function when the CPU Unit is set to the RUN Mode. (MONITOR Mode is not available with the NJ-Series CPU Units.)

*2 When an NT-AL001 RS-232C/RS-422A Conversion Unit is used, this value increases by 0.15 A/Unit. Add 0.20A/Unit when using NV3W-M□20L Programmable Terminals. Add 0.04A/Unit when using CJ1W-CIF11 RS-422A Adapters.

*3 Supported only by the SerialRcvNoClear Instructions with Serial communication unit version 2.1 or later, CPU Units with unit version 1.03 or later and the Sysmac Studio version 1.04 or higher.

EtherNet/IP Unit

Unit classification	Product name	Specifications			No. of unit numbers allocated	Current consumption (A)		Model
		Communications cable	Communications functions	Max. Units mountable per CPU Unit		5 V	24 V	
CJ1 CPU Bus Unit	 EtherNet/IP Unit	Shielded twisted-pair (STP) cable Categories: 100 Ω at 5, 5e	Tag Data Link Functions, Message Communications Functions, Socket Service Functions	4	1	0.65	---	CJ1W-EIP21S *1
			Tag Data Link Functions, Message Communications Functions			0.41		CJ1W-EIP21 *1, *2

*1 EtherNet/IP Unit with unit version 1.0 or later (Lot number 241001□ or later) is required to connect CJ1W-EIP21S to NJ-series CPU Unit. Use NJ-series CPU Unit with version 1.67 or later and Sysmac Studio with version 1.60 or later.

EtherNet/IP Unit with unit version 2.1 or later is required to connect CJ1W-EIP21 to NJ-series CPU Unit. Use NJ-series CPU Unit with version 1.01 or later and Sysmac Studio with version 1.02 or later.

*2 Product no longer available to order.

EtherCAT Slave Unit

Unit classification	Product name	Specifications	Communications type	No. of unit numbers allocated	Current consumption (A)		Model
					5 V	24 V	
CJ1 CPU Bus Units	 EtherCAT Slave Unit	STP (shielded twisted-pair) cable of category 5 or higher with double shielding	Refreshing methods: Free-Run Mode PDO DATA SIZE: TxPDO 400byte or less/RxPDO: 400byte or less	1	0.34	---	CJ1W-ECT21 *

* When using with the Machine Automation Controller NJ /NXSeries, use CPU Units with unit version 1.10 or later and the Sysmac Studio version 1.13 or higher.

DeviceNet Unit

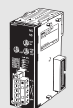
Unit classification	Product name	Specifications	Communications type	No. of unit numbers allocated	Current consumption (A)		Model
					5 V	24 V	
CJ1 CPU Bus Units	 DeviceNet Unit	Functions as master and/or slave; allows control of 32,000 points max. per master.	<ul style="list-style-type: none"> Remote I/O communications master (fixed or user-set allocations) Remote I/O communications slave (fixed or user-set allocations) Message communications 	1	0.29	---	CJ1W-DRM21

Note: 1. Simple backup function cannot be used.
2. DeviceNet configurator cannot be used. Use CX-Integrator.

CompoNet Master Unit

Unit classification	Product name	Specifications		No. of unit numbers allocated	Current consumption (A)		Model
		Communications functions	No. of I/O points per Master Unit		5 V	24 V	
CJ1 Special I/O Units	 CompoNet Master Unit	Remote I/O communications Message communications	Word Slaves: 2,048 max. (1,024 inputs and 1,024 outputs) Bit Slaves: 512 max. (256 inputs and 256 outputs)	1, 2, 4, or 8	0.4	---	CJ1W-CRM21 *

Note: 1. Simple backup function cannot be used.
2. The FINS command to the CompoNet Master Unit cannot be issued.

* Supported only by the CPU Units with unit version 1.01 or later and the Sysmac Studio version 1.02 or higher.

ID Sensor Units

Unit classification	Product name	Specifications			No. of unit numbers allocated	Current consumption (A)		Model
		Connected ID Systems	No. of connected R/W heads	External power supply		5 V	24 V	
CJ1 CPU Bus Units	 ID Sensor Units V680-Series RFID System		1	Not required.	1	0.26	0.13 *	CJ1W-V680C11
			2		2	0.32	0.26	CJ1W-V680C12

Note: The data transfer function using intelligent I/O commands can not be used.

* To use a V680-H01 Antenna, refer to the V680 Series RFID System Catalog (Cat. No. Q151).

Peripheral Devices

EtherCAT junction slaves

Product name	No. of ports	Power supply voltage	Current consumption (A)	Model
 EtherCAT junction slaves	3	20.4 to 28.8 VDC (24 VDC -15 to +20%)	0.08	GX-JC03
	6		0.17	GX-JC06

Note: 1. Please do not connect EtherCAT junction slaves with OMRON position control unit, Model CJ1W-NC□81/□82.

2. EtherCAT junction slaves cannot be used for EtherNet/IP and Ethernet.

Industrial Switching Hubs for EtherNet/IP and Ethernet

Product name	Appearance	Functions	No. of ports	Accessories	Current consumption (A)	Model
 Industrial Switching Hubs		Quality of Service (QoS): EtherNet/IP control data priority 10/100BASE-TX, Auto-Negotiation	5	Power supply connector	0.07	W4S1-05D

Note: Industrial switching hubs cannot be used for EtherCAT.

WE70 FA WIRELESS LAN UNITS (Final order entry date: The end of June, 2020)

Product name	Applicable region	Type	Model
 WE70 FA WIRELESS LAN UNITS	Japan	Access Point (Master)	WE70-AP
		Client (Slave)	WE70-CL
	Europe	Access Point (Master)	WE70-AP-EU
		Client (Slave)	WE70-CL-EU
	U.S	Access Point (Master)	WE70-AP-US *1
		Client (Slave)	WE70-CL-US *1
	Canada	Access Point (Master)	WE70-AP-CA *2
		Client (Slave)	WE70-CL-CA *2
	China	Access Point (Master)	WE70-AP-CN
		Client (Slave)	WE70-CL-CN

Note: 1. A Pencil Antenna, mounting magnet, and screw mounting bracket are included as accessories.

2. Always use a model that is applicable in your region. Refer to the WE70 Catalog (Cat. No. N154).

*1. From December 2015, the WE70-AP-US and WE70-CL-US can be used in Mexico.
The Units will be sold in the USA until the end of May 2016.

*2. From January 2016, the WE70-AP-CA and WE70-CL-CA can be used in Singapore.

General Specifications

Item	Specification		
	NJ501-□□□□	NJ301-□□□□	NJ101-□□□□
Enclosure	Mounted in a panel		
Grounding Method	Ground to less than 100 Ω		
Dimensions (height×depth×width)	90 mm × 90 mm × 90 mm		
Weight	550 g (including the End Cover)		
Current Consumption	5 VDC, 1.90 A (including SD Memory Card and End Cover)		
Operation Environment	Ambient Operating Temperature	0 to 55°C	
	Ambient Operating Humidity	10% to 90% (with no condensation)	
	Atmosphere	Must be free from corrosive gases.	
	Ambient Storage Temperature	-20 to 75°C (excluding battery)	
	Altitude	2,000 m or less	
	Pollution Degree	2 or less: Meets IEC 61010-2-201.	
	Noise Immunity	2 kV on power supply line (Conforms to IEC 61000-4-4.)	
	Overvoltage Category	Category II: Meets IEC 61010-2-201.	
	EMC Immunity Level	Zone B	
	Vibration Resistance	Conforms to IEC 60068-2-6. 5 to 8.4 Hz with 3.5-mm amplitude, 8.4 to 150 Hz Acceleration of 9.8 m/s ² for 100 min in X, Y, and Z directions (10 sweeps of 10 min each = 100 min total)	
Shock Resistance	Conforms to IEC 60068-2-27. 147 m/s ² , 3 times in X, Y, and Z directions (100 m/s ² for Relay Output Units)		
Battery	Life *1	5 years at 25°C	
	Model	CJ1W-BAT01	
Applicable Standards *2	cULus, EU, UKCA, RCM, KC, NK, LR *3		

*1. This is the value when the power ON time rate is 0% (power OFF).

*2. Refer to the OMRON website (<http://www.ia.omron.com/>) or consult your OMRON representative for the most recent applicable standards for each model.

*3. Supported only by the CPU Units with unit version 1.01 or later.

Performance Specifications

Item			NJ501-			NJ301-		NJ101-		
			□5□0	□4□0	□3□0	1200	1100	1□□0	9□□0	
Processing Time	Instruction Execution Times	LD instruction	1.1 ns (1.7 ns or less)			1.6 ns (2.5 ns or less) *2		3.0 ns (4.5 ns or less) *2		
		Math Instructions (for Long Real Data)	24 ns or more *1			35 ns or more *2		63 ns or more *2		
Programming	Program capacity *3	Size	20 MB (400 KS)			5 MB (100 KS)		3 MB (60 KS)		
		Number	POU definition	3,000			750		450	
			POU instance	Using Sysmac Studio Ver. 1.05 or lower : 6,000 Using Sysmac Studio Ver. 1.06 or higher : 9,000			Using Sysmac Studio Ver. 1.04 or lower : 1,500 Using Sysmac Studio Ver. 1.05 or higher : 3,000		1,800	
	Variables capacity	No Retain Attribute *4	Size	4 MB			2 MB			
			Number	180,000 *5			90,000 *6		22,500	
		Retain Attribute *7	Size	2 MB			0.5 MB			
			Number	10,000			Using Sysmac Studio Ver. 1.04 or lower : 2,500 Using Sysmac Studio Ver. 1.05 or higher : 5,000		5,000	
	Data type	Number	2,000			1,000				
	Memory for CJ-Series Units (Can be Specified with AT Specifications for Variables.)	CIO Area	6,144 words (CIO 0 to CIO 6143)							
		Work Area	512 words (W0 to W511)							
Holding Area		1,536 words (H0 to H1535)								
DM Area		32,768 words (D0 to D32767)								
EM Area		32,768 words × 25 banks (E0_00000 to E18_32767) *8			32,768 words × 4 banks (E0_00000 to E3_32767) *8					
Unit Configuration	Maximum Number of Connectable Units	Maximum number of CJ unit per CPU Rack or Expansion Rack	10 Units							
		Maximum number of CJ unit on the system	40 Units							
		Maximum number of NX unit on the system	4,096 (on NX series EtherCAT slave terminal)					400 (on NX series EtherCAT slave terminal)		
	Maximum number of Expansion Racks	3 max.								
	I/O Capacity	Maximum number of I/O Points on CJ-series Units	2,560 points max.							
	Power Supply Unit for CPU Rack and Expansion Racks	Model	NJ-P□3001							
		Power OFF Detection Time	AC Power Supply	30 to 45 ms						
DC Power Supply	22 to 25 ms									
Motion Control	Number of Controlled Axes	Maximum Number of Controlled Axes	Maximum number of axes which can be defined.							
			64 axes	32 axes	16 axes	15 axes *9	15 axes *9	6 axes		
		Motion control axes	Maximum number of motion control axes which can be defined. All motion control function is available.							
			64 axes	32 axes	16 axes	15 axes	15 axes	6 axes		
		Maximum number of used real axes	Maximum number of used real axes. The Number of used real axes includes following servo axes and encoder axes.							
			64 axes	32 axes	16 axes	8 axes	4 axes	2 axes		
		Used motion control servo axes	Maximum number of servo axes which all motion control function is available.							
			64 axes	32 axes	16 axes	8 axes	4 axes	2 axes		
		Maximum number of axes for linear interpolation axis control	4 axes per axes group							
		Number of axes for circular interpolation axis control	2 axes per axes group							
Maximum Number of Axes Groups	32 groups									
Motion Control Period	The same control period as that is used for the process data communications cycle for EtherCAT.									

*1. When the hardware revision for the Unit is A or B.

*2. When the hardware revision for the Unit is A.

*3. This is the capacity for the execution objects and variable tables (including variable names).

*4. Words for CJ-series Units in the Holding, DM, and EM Areas are not included.

*5. The number of variables of the CPU Unit version 1.19 or earlier is 90,000.

*6. The number of variables of the CPU Unit version 1.18 or earlier is 22,500.

*7. Words for CJ-series Units in the CIO and Work Areas are not included.

*8. When the Spool function of the NJ501-□□20 is enabled, the DB Connection Service uses E9_0 to E18_32767 (NJ501-1□□20).

When the Spool function of the NJ101-□□20 is enabled, the DB Connection Service uses E1_0 to E3_32767 (NJ101-□□20).

*9. This number of axes is achieved in a combination of a CPU Unit with unit version 1.06 or later and Sysmac Studio version 1.07 or higher. In other combinations, the maximum number of controlled axes is 8 axes (NJ301-1200) or 4 axes (NJ301-1100).

Item			NJ501-			NJ301-		NJ101	
			□5□0	□4□0	□3□0	1200	1100	1□□0	9□□0
Motion Control	Cams	Number of Cam Data Points	Maximum Points per Cam Table	65,535 points					---
			Maximum Points for All Cam Tables	1,048,560 points		262,140 points			
		Maximum Number of Cam Tables	640 tables		160 tables				
	Position Units	Pulses, millimeters, micrometers, nanometers, degrees or inches							
	Override Factors	0.00% or 0.01% to 500.00%							
Peripheral USB Port	Supported Services		Sysmac Studio connection						
	Physical Layer		USB 2.0-compliant B-type connector						
	Transmission Distance between Hub and Node		5 m max.						
Built-in EtherNet/IP Port	Number of port		1						
	Physical Layer		10Base-T or 100Base-TX						
	Frame length		1514 max.						
	Media Access Method		CSMA/CD						
	Modulation		Baseband						
	Topology		Star						
	Baud Rate		100 Mbps (100Base-TX)						
	Transmission Media		STP (shielded, twisted-pair) cable of Ethernet category 5, 5e or higher						
	Maximum Transmission Distance between Ethernet Switch and Node		100m						
	Maximum Number of Cascade Connections		There are no restrictions if Ethernet switch is used.						
	CIP service: Tag Data Links (Cyclic Communications)	Maximum Number of Connections		32					
		Packet interval *10		1 to 10,000 ms in 1.0-ms increments *11 Can be set for each connection. (Data will be refreshed at the set interval, regardless of the number of nodes.)					
		Permissible Communications Band		3,000 pps *12 *13 (including heartbeat)					
		Maximum Number of Tag Sets		32					
		Tag types		Network variables, CIO, Work, Holding, DM, and EM Areas					
		Number of tags per connection (i.e., per tag set)		8 (7 tags if Controller status is included in the tag set.)					
		Maximum Link Data Size per Node (total size for all tags)		256					
		Maximum number of tag		19,200 bytes					
		Maximum Data Size per Connection		600 bytes					
		Maximum Number of Registrable Tag Sets		32 (1 connection = 1 tag set)					
	Cip Message Service: Explicit Messages	Maximum Tag Set Size		600 bytes (Two bytes are used if Controller status is included in the tag set.)					
		Multi-cast Packet Filter *14		Supported.					
		Class 3 (number of connections)		32 (clients plus server)					
UCMM (non-connection type)		Maximum Number of Clients that Can Communicate at One Time	32						
		Maximum Number of Servers that Can Communicate at One Time	32						
Maximum number of TCP socket service			30 *15					30	

*10.Data is updated on the line in the specified interval regardless of the number of nodes.
 *11.The Packet interval of the CPU Unit version 1.02 or earlier is 10 to 10,000 ms in 1.0-ms increments.
 *12.Means packets per second, i.e., the number of communications packets that can be sent or received in one second.
 *13.The Permissible Communications Band of the CPU Unit version 1.02 or earlier is 1,000 pps.
 *14.An IGMP client is mounted for the EtherNet/IP port. If an ethernet switch that supports IGMP snooping is used, filtering of unnecessary multicast packets is performed.
 *15.The Maximum number of TCP socket service of the CPU Unit version 1.02 or earlier is 16.

Item		NJ501-			NJ301-		NJ101		
		□5□0	□4□0	□3□0	1200	1100	1□□0	9□□0	
Built-in EtherNet/IP Port	OPC UA Server (NJ501-1□00)	Support Profile/Model	Embedded 2017 UA Server Profile PLCopen Information Model 1.00			---		---	
		Default Endpoint/Port	opc.tcp://192.168.250.1:4840/			---		---	
		Maximum number of sessions (Client)	5			---		---	
		Maximum number of Monitored Items per server	2,000			---		---	
		Sampling rate of the Monitored Items (ms)	0, 50, 100, 250, 500, 1000,2000, 5000, 10000 if set to 0 (zero), it is assumed that is set to 50.			---		---	
		Maximum number of Subscriptions per server	100			---		---	
		Maximum number of variables that can be published	10,000			---		---	
		Maximum number of structure definitions that can be published	100			---		---	
		Restrictions on variables unable to be published	<ul style="list-style-type: none"> • Variable which size are over 60 KB • Double and over dimensional array of structures (global variables) • Structures includes double and over dimensional array (global variables) • Structures nested 4 and over Unions • Array which's index number don't start from 0 • Array which's element is over 2048 (global variables) • Structures which's members are over 100. 			---		---	
		SecurityPolicy/Mode	<ul style="list-style-type: none"> • None • Sign - Basic128Rsa15 • Sign - Basic256 • Sign - Basic256Sha256 • Sign - Aes128Sha256RsaOaep • Sign - Aes256Sha256RsaPss • SignAndEncrypt - Basic128Rsa15 • SignAndEncrypt - Basic256 • SignAndEncrypt - Basic256Sha256 • SignAndEncrypt - Aes128Sha256RsaOaep • SignAndEncrypt - Aes256Sha256RsaPss 			---		---	
Application Authentication	Authentication	X.509			---		---		
	Maximum number of certification	Trusted certification: 32 Issuer certification: 32 Rejected certification: 32			---		---		
User Authentication	Authentication	User name / Password / Role *16 Anonymous			---		---		
Built-in EtherCAT Port	Communications Standard		IEC 61158 Type12						
	EtherCAT Master Specifications		Class B (Feature Pack Motion Control compliant)						
	Physical Layer		100BASE-TX						
	Modulation		Baseband						
	Baud Rate		100 Mbps (100Base-TX)						
	Duplex mode		Auto						
	Topology		Line, daisy chain, branching and ring *17						
	Transmission Media		Twisted-pair cable of category 5 or higher (double-shielded straight cable with aluminum tape and braiding)						
	Maximum Transmission Distance between Nodes		100m						
	Maximum Number of Slaves		192				64		
	Range of node address		1-192						
	Maximum Process Data Size		Inputs: 5,736 bytes Outputs: 5,736 bytes *18						
	Maximum Process Data Size per Slave		Inputs: 1,434 bytes Outputs: 1,434 bytes						
	Communications Cycle		500/1,000/2,000/4,000 μs *19				1,000/2,000/4,000 μs		
Sync Jitter		1 μs max.							
Internal Clock *20		At ambient temperature of 55°C: -4.5 to +4.5 min error per month At ambient temperature of 25°C: -3.5 to +3.5 min error per month At ambient temperature of 0°C: -4.5 to +4.5 min error per month							

*16.Roles can be set for the unit versions 1.62 or later of CPU Units.

*17.Ring topology is supported with the project version 1.40 or later.

Slaves on a ring topology should support a ring topology. If Omron slaves, please see the user's manual of slaves.

*18.For project unit version earlier than 1.40, the data must be within four frames.

*19.The Maximum Communications Cycle of the NJ301 CPU Unit version 1.02 or earlier and NJ501-R□□□ are 1,000/2,000/4,000 μs.

The EtherCAT communications cycle of NJ501-4□□□ for robot control is 1 ms or more.

*20.The values shown are values in continuous operation.

Note: For robot control by NJ501-4□□□, use the G5 series/1S series AC Servo Drive with built-in EtherCAT communications, absolute encoder, and brake.

Performance Specifications Supported by NC Integrated Controller

Item			NJ501-	
			5300	
Numerical Control	Task Period	Primary periodic cycle	500/1,000/2,000/4,000 μs	
		CNC Planner Service period	500 μs to 16 ms	
	Number of CNC motors	Maximum number of CNC motors	16	
		CNC Coordinate system	Maximum number of CNC coordinate systems	4
	Maximum number of CNC motor configurations that are included in a CNC coordinate system (excluding spindle axes)		8	
	Number of spindle axes that are included in a CNC coordinate system		1	
	Number of simultaneous interpolation axes		4	
	NC Program	Program buffer size *1	16 MB	
		Maximum number of programs	Upper limit of main registrations	512
			Upper limit of sub registrations	512
	NC program variables	P variable	Double-precision floating point 65536 *2	
		Q variable	Double-precision floating point 8192 *2	
		L variable	Double-precision floating point 256	
	CNC motor compensation table	Maximum number of CNC motor compensation tables	32	
		Maximum size of all compensation tables	1 MB	

- *1. The number of programs and their capacities that can be loaded into the CPU Unit at the same time.
The program capacity is the maximum size available. As fragmentation will occur, the size that is actually available will be smaller than the maximum size.
- *2. Some parts of the area are reserved by the system.

Function Specifications

Item		NJ501-□□□□	NJ301-□□□□	NJ101-□□□□		
Tasks	Function	I/O refreshing and the user program are executed in units that are called tasks. Tasks are used to specify execution conditions and execution priority.				
		Periodically Executed Tasks	Maximum Number of Primary Periodic Tasks	1		
			Maximum Number of Periodic Tasks	3		
		Conditionally executed tasks *1	Maximum number of event tasks	32		
			Execution conditions	When Activate Event Task instruction is executed or when condition expression for variable is met.		
	System Service Tasks (NJ501-R□□□)	Maximum number of V+ Tasks	64	---		
Setup	System Service Monitoring Settings		The execution interval and the percentage of the total user program execution time are monitored for the system services (processes that are executed by the CPU Unit separate from task execution).			
Programming	POU (program organization units)	Programs		POUs that are assigned to tasks.		
		Function Blocks		POUs that are used to create objects with specific conditions.		
		Functions		POUs that are used to create an object that determine unique outputs for the inputs, such as for data processing.		
	Programming Languages	Types		Ladder diagrams *2 Structured text (ST) V+ (NJ501-R□□□)		
	Namespaces *3		A concept that is used to group identifiers for POU definitions.			
	Variables	External Access of Variables	Network Variables		The function which allows access from the HMI, host computers, or other Controllers	
	Data Types	Data Types	Boolean		BOOL	
			Bit Strings		BYTE, WORD, DWORD, LWORD	
			Integers		INT, SINT, DINT,LINT, UINT, USINT, UDINT, ULINT	
			Real Numbers		REAL, LREAL	
			Durations		TIME	
			Dates		DATE	
			Times of Day		TIME_OF_DAY	
			Date and Time		DATE_AND_TIME	
		Text Strings		STRING		
		Derivative Data Types		Structures, unions, enumerations		
		Structures	Function		A derivative data type that groups together data with different variable types.	
			Maximum Number of Members		2048	
			Nesting Maximum Levels		8	
	Member Data Types		Basic data types, structures, unions, enumerations, array variables			
Specifying Member Offsets			You can use member offsets to place structure members at any memory locations.*3			
Unions	Function		A derivative data type that groups together data with different variable types.			
	Maximum Number of Members		4			
	Member Data Types		BOOL, BYTE, WORD, DWORD, LWORD			
Enumerations	Function		A derivative data type that uses text strings called enumerators to express variable values.			
Data Type Attributes	Array Specifications	Function		An array is a group of elements with the same data type. You specify the number (subscript) of the element from the first element to specify the element.		
		Maximum Number of Dimensions		3		
		Maximum Number of Elements		65535		
		Array Specifications for FB Instances		Supported.		
	Range Specifications		You can specify a range for a data type in advance. The data type can take only values that are in the specified range.			
Libraries *3		User libraries				

*1. Supported only by the CPU Units with unit version 1.03 or later.

*2. Inline ST is supported. (Inline ST is ST that is written as an element in a ladder diagram.)

*3. Supported only by the CPU Units with unit version 1.01 or later.

Item		NJ501-□□□□	NJ301-□□□□	NJ101-□□□□		
Motion Control	Single-axis	Control Modes		position control, velocity control, torque control		
		Axis Types		Servo axes, virtual servo axes, encoder axes, and virtual encoder axes		
		Positions that can be managed		Command positions and actual positions		
		Single-axis Position Control	Absolute Positioning	Positioning is performed for a target position that is specified with an absolute value.		
			Relative Positioning	Positioning is performed for a specified travel distance from the command current position.		
			Interrupt Feeding	Positioning is performed for a specified travel distance from the position where an interrupt input was received from an external input.		
		Single-axis Velocity Control	Cyclic synchronous absolute positioning *1	The function which outputs command positions in every control period in the position control mode.		
			Velocity Control	Velocity control is performed in Position Control Mode.		
		Single-axis Torque Control	Cyclic Synchronous Velocity Control	A velocity command is output each control period in Velocity Control Mode.		
			Torque Control	The torque of the motor is controlled.		
		Single-axis Synchronized Control	Starting Cam Operation	A cam motion is performed using the specified cam table.		
			Ending Cam Operation	The cam motion for the axis that is specified with the input parameter is ended.		
			Starting Gear Operation	A gear motion with the specified gear ratio is performed between a master axis and slave axis.		
			Positioning Gear Operation	A gear motion with the specified gear ratio and sync position is performed between a master axis and slave axis.		
			Ending Gear Operation	The specified gear motion or positioning gear motion is ended.		
			Synchronous Positioning	Positioning is performed in sync with a specified master axis.		
			Master Axis Phase Shift	The phase of a master axis in synchronized control is shifted.		
		Single-axis Manual Operation	Combining Axes	The command positions of two axes are added or subtracted and the result is output as the command position.		
			Powering the Servo	The Servo in the Servo Drive is turned ON to enable axis motion.		
		Auxiliary Functions for Single-axis Control	Jogging	An axis is jogged at a specified target velocity.		
			Resetting Axis Errors	Axes errors are cleared.		
			Homing	A motor is operated and the limit signals, home proximity signal, and home signal are used to define home.		
			Homing with parameter *1	Specifying the parameter, a motor is operated and the limit signals, home proximity signal, and home signal are used to define home.		
			High-speed Homing	Positioning is performed for an absolute target position of 0 to return to home.		
			Stopping	An axis is decelerated to a stop at the specified rate.		
			Immediately Stopping	An axis is stopped immediately.		
			Setting Override Factors	The target velocity of an axis can be changed.		
			Changing the Current Position	The command current position or actual current position of an axis can be changed to any position.		
Enabling External Latches	The position of an axis is recorded when a trigger occurs.					
Disabling External Latches	The current latch is disabled.					
Zone Monitoring	You can monitor the command position or actual position of an axis to see when it is within a specified range (zone).					
Enabling digital cam switches *4	You can turn a digital output ON and OFF according to the position of an axis.					
Monitoring Axis Following Error	You can monitor whether the difference between the command positions or actual positions of two specified axes exceeds a threshold value.					
Resetting the Following Error	The error between the command current position and actual current position is set to 0.					
Torque Limit	The torque control function of the Servo Drive can be enabled or disabled and the torque limits can be set to control the output torque.					
Slave Axis Position Compensation *5	This function compensates the position of the slave axis currently in synchronized control.					
Cam monitor (NJ□01-□□00)	Outputs the specified offset position for the slave axis in synchronous control.					
Start velocity *6	You can set the initial velocity when axis motion starts.					

*1. Supported only by the CPU Units with unit version 1.03 or later.

*4. Supported only by the CPU Units with unit version 1.06 or later.

*5. Supported only by the CPU Units with unit version 1.10 or later.

*6. Supported only by the CPU Units with unit version 1.05 or later.

Item			NJ501-□□□□	NJ301-□□□□	NJ101-□□□□
Motion Control	Axes Groups	Multi-axes Co-ordinated Control	Absolute Linear Interpolation	Linear interpolation is performed to a specified absolute position.	
			Relative Linear Interpolation	Linear interpolation is performed to a specified relative position.	
			Circular 2D Interpolation	Circular interpolation is performed for two axes.	
		Axes Group Cyclic Synchronous Absolute Positioning	A positioning command is output each control period in Position Control Mode.*3		
		Auxiliary Functions for Multi-axes Coordinated Control	Resetting Axes Group Errors	Axes group errors and axis errors are cleared.	
			Enabling Axes Groups	Motion of an axes group is enabled.	
			Disabling Axes Groups	Motion of an axes group is disabled.	
			Stopping Axes Groups	All axes in interpolated motion are decelerated to a stop.	
			Immediately Stopping Axes Groups	All axes in interpolated motion are stopped immediately.	
			Setting Axes Group Override Factors	The blended target velocity is changed during interpolated motion.	
		Reading Axes Group Positions	The command current positions and actual current positions of an axes group can be read.*3		
		Changing the Axes in an Axes Group	The Composition Axes parameter in the axes group parameters can be overwritten temporarily.*3		
		Common Items	Cams	Setting Cam Table Properties	The end point index of the cam table that is specified in the input parameter is changed.
	Saving Cam Tables			The cam table that is specified with the input parameter is saved in non-volatile memory in the CPU Unit.	
	Generating cam tables *7			The cam table that is specified with the input parameter is generated from the cam property and cam node.	
	Parameters		Writing MC Settings	Some of the axis parameters or axes group parameters are overwritten temporarily.	
			Changing axis parameters *7	You can access and change the axis parameters from the user program.	
	Auxiliary Functions	Count Modes		You can select either Linear Mode (finite length) or Rotary Mode (infinite length).	
		Unit Conversions		You can set the display unit for each axis according to the machine.	
		Acceleration/Deceleration Control	Automatic Acceleration/Deceleration Control	Jerk is set for the acceleration/deceleration curve for an axis motion or axes group motion.	
			Changing the Acceleration and Deceleration Rates	You can change the acceleration or deceleration rate even during acceleration or deceleration.	
		In-position Check		You can set an in-position range and in-position check time to confirm when positioning is completed.	
		Stop Method		You can set the stop method to the immediate stop input signal or limit input signal.	
		Re-execution of Motion Control Instructions		You can change the input variables for a motion control instruction during execution and execute the instruction again to change the target values during operation.	
		Multi-execution of Motion Control Instructions (Buffer Mode)		You can specify when to start execution and how to connect the velocities between operations when another motion control instruction is executed during operation.	
		Continuous Axes Group Motions (Transition Mode)		You can specify the Transition Mode for multi-execution of instructions for axes group operation.	
		Monitoring Functions	Software Limits		Software limits are set for each axis.
Following Error			The error between the command current value and the actual current value is monitored for an axis.		
Velocity, Acceleration Rate, Deceleration Rate, Torque, Interpolation Velocity, Interpolation Acceleration Rate, And Interpolation Deceleration Rate			You can set and monitor warning values for each axis and each axes group.		
Absolute Encoder Support		You can use an OMRON G5-Series or 1S-Series Servomotor with an Absolute Encoder to eliminate the need to perform homing at startup.			
Input signal logic inversion *6		You can inverse the logic of immediate stop input signal, positive limit input signal, negative limit input signal, or home proximity input signal.			
External Interface Signals			The Servo Drive input signals listed on the right are used. Home signal, home proximity signal, positive limit signal, negative limit signal, immediate stop signal, and interrupt input signal		

*3. Supported only by the CPU Units with unit version 1.01 or later.

*6. Supported only by the CPU Units with unit version 1.05 or later.

*7. Supported only by the CPU Units with unit version 1.08 or later.

		Item	NJ501-□□□□	NJ301-□□□□	NJ101-□□□□		
Unit (I/O) Management	EtherCAT Slaves	Maximum Number of Slaves	192		64		
	CJ-Series Units	Maximum number of Units	40				
		Basic I/O Units	Load Short-circuit Protection and I/O Disconnection Detection	Alarm information for Basic I/O Units is read.			
Communications	Peripheral USB Port		A port for communications with various kinds of Support Software running on a personal computer.				
	Secure Communications		Function for secure communication with support software				
	Built-in EtherNet/IP port Internal Port	Communications protocol		TCP/IP, UDP/IP			
		CIP Communications Service	Tag Data Links	Programless cyclic data exchange is performed with the devices on the EtherNet/IP network.			
			Message Communications	CIP commands are sent to or received from the devices on the EtherNet/IP network.			
		TCP/IP functions	CIDR	The function which performs IP address allocations without using a class (class A to C) of IP address.			
		TCP/IP Applications	Socket Services		Data is sent to and received from any node on Ethernet using the UDP or TCP protocol. Socket communications instructions are used.		
			FTP client *7		File can be read from or written to computers at other Ethernet nodes from the CPU Unit. FTP client communications instructions are used.		
			FTP Server		Files can be read from or written to the SD Memory Card in the CPU Unit from computers at other Ethernet nodes.		
			Automatic Clock Adjustment		Clock information is read from the NTP server at the specified time or at a specified interval after the power supply to the CPU Unit is turned ON. The internal clock time in the CPU Unit is updated with the read time.		
		SNMP Agent		Built-in EtherNet/IP port internal status information is provided to network management software that uses an SNMP manager.			
		OPC UA (NJ501-1□□00)	Server Function		---	---	
	EtherCAT Port	Supported Services	Process Data Communications	Control information is exchanged in cyclic communications between the EtherCAT master and slaves.			
			SDO Communications	A communications method to exchange control information in noncyclic event communications between EtherCAT master and slaves. This communications method is defined by CoE.			
		Network Scanning		Information is read from connected slave devices and the slave configuration is automatically generated.			
		DC (Distributed Clock)		Time is synchronized by sharing the EtherCAT system time among all EtherCAT devices (including the master).			
		Enable/disable Settings for Slaves		The slaves can be enabled or disabled as communications targets.			
Disconnecting/Connecting Slaves		Temporarily disconnects a slave from the EtherCAT network for maintenance, such as for replacement of the slave, and then connects the slave again.					
Supported Application Protocol	CoE	SDO messages of the CAN application can be sent to slaves via EtherCAT.					
		Communications Instructions					
		The following instructions are supported. CIP communications instructions, socket communications instructions, SDO message instructions, no-protocol communications instructions, protocol macro instructions, and FTP client instructions *7, and Modbus RTU protocol instructions *8					
Operation Management	RUN Output Contacts		The output on the Power Supply Unit turns ON in RUN mode.				
System Management	Event Logs	Function		Events are recorded in the logs.			
		Maximum number of events	System event log	1,024	512		
			Access event log	1,024	512		
			User-defined event log	1,024	512		

*6. Supported only by the CPU Units with unit version 1.05 or later.

*7. Supported only by the CPU Units with unit version 1.08 or later.

*8. Supported only by the CPU Units with unit version 1.11 or later.

Item			NJ501-□□□□	NJ301-□□□□	NJ101-□□□□	
Debugging	Online Editing	Single	Programs, function blocks, functions, and global variables can be changed online. Different operators can change different POU's across a network.			
	Forced Refreshing			The user can force specific variables to TRUE or FALSE.		
		Maximum Number of Forced Variables	Device Variables for Ether-CAT Slaves	64		
	Device Variables for CJ-series Units and Variables with AT Specifications		64			
	MC Test Run *9		Motor operation and wiring can be checked from the Sysmac Studio.			
	Synchronizing		The project file in the Sysmac Studio and the data in the CPU Unit can be made the same when online.			
	Differentiation monitoring *1		Rising/falling edge of contacts can be monitored.			
			Maximum number of contacts *1	8		
	Data Tracing	Types	Single Triggered Trace	When the trigger condition is met, the specified number of samples are taken and then tracing stops automatically.		
			Continuous Trace	Data tracing is executed continuously and the trace data is collected by the Sysmac Studio.		
		Maximum Number of Simultaneous Data Trace		4 *10	2	
		Maximum Number of Records		10,000		
		Sampling	Maximum Number of Sampled Variables	192 variables	48 variables	
		Timing of Sampling		Sampling is performed for the specified task period, at the specified time, or when a sampling instruction is executed.		
Triggered Traces		Trigger conditions are set to record data before and after an event.				
		Trigger Conditions	When BOOL variable changes to TRUE or FALSE Comparison of non-BOOL variable with a constant Comparison Method: Equals (=), Greater than (>), Greater than or equals (≥), Less Than (<), Less than or equals (≤), Not equal (≠)			
		Delay	Trigger position setting: A slider is used to set the percentage of sampling before and after the trigger condition is met.			
Simulation		The operation of the CPU Unit is emulated in the Sysmac Studio.				
Reliability Functions	Self-diagnosis	Controller Errors	Levels	Major fault, partial fault, minor fault, observation, and information		
		User-defined errors		User-defined errors are registered in advance and then records are created by executing instructions.		
		Levels		8 levels		
Security	Protecting Software Assets and Preventing Operating Mistakes	CPU Unit Names and Serial IDs		When going online to a CPU Unit from the Sysmac Studio, the CPU Unit name in the project is compared to the name of the CPU Unit being connected to.		
		Protection	User Program Transfer with No Restoration Information	You can prevent reading data in the CPU Unit from the Sysmac Studio.		
			CPU Unit Write Protection	You can prevent writing data to the CPU Unit from the Sysmac Studio or SD Memory Card.		
			Overall Project File Protection	You can use passwords to protect .smc files from unauthorized opening on the Sysmac Studio.		
			Data Protection	You can use passwords to protect POU's on the Sysmac Studio.*3		
		Verification of Operation Authority		Online operations can be restricted by operation rights to prevent damage to equipment or injuries that may be caused by operating mistakes.		
				Number of Groups	5 *11	5
Verification of User Program Execution ID		The user program cannot be executed without entering a user program execution ID from the Sysmac Studio for the specific hardware (CPU Unit).				
SD Memory Card Functions	Storage Type		SD Memory Card, SDHC Memory Card			
	Application	Automatic transfer from SD Memory Card *1		The data in the autoloader folder on an SD Memory Card is automatically loaded when the power supply to the Controller is turned ON.		
		Transfer program from SD Memory Card *8		The user program on an SD Memory Card is loaded when the user changes system-defined variable to TRUE.		
		SD Memory Card Operation Instructions		You can access SD Memory Cards from instructions in the user program.		
		File Operations from the Sysmac Studio		You can perform file operations for Controller files in the SD Memory Card and read/write standard document files on the computer.		
SD Memory Card Life Expiration Detection		Notification of the expiration of the life of the SD Memory Card is provided in a system-defined variable and event log.				

*1. Supported only by the CPU Units with unit version 1.03 or later.

*3. Supported only by the CPU Units with unit version 1.01 or later.

*8. Supported only by the CPU Units with unit version 1.11 or later.

*9. Cannot be used with the NJ101-9000.

*10. Maximum Number of Simultaneous Data Trace of the NJ501-□□20 CPU Unit with unit version 1.08 or later is 2.

*11. When the NJ501 CPU Units with unit version 1.00 is used, this value becomes two.

Item			NJ501-□□□□	NJ301-□□□□	NJ101-□□□□
Backup functions *1	SD Memory Card backup functions	Operation	Using front switch	You can use front switch to backup, compare, or restore data.	
			Using system-defined variables	You can use system-defined variables to backup, compare, or restore data. *12	
			Memory Card Operations Dialog Box on Sysmac Studio	Backup and verification operations can be performed from the SD Memory Card Operations Dialog Box on the Sysmac Studio.	
		Using instruction *7	Backup operation can be performed by using instruction.		
	Protection	Prohibiting backing up data to the SD Memory Card	Prohibit SD Memory Card backup functions.		
Sysmac Studio Controller backup functions			Backup, restore, and verification operations for Units can be performed from the Sysmac Studio.		

*1. Supported only by the CPU Units with unit version 1.03 or later.

*7. Supported only by the CPU Units with unit version 1.08 or later.

*12. Restore is supported with unit version 1.14 or later.

Function Specifications of Database Connection CPU Units

Besides functions of the NJ501-□□□□/NJ101-□□□□, functions supported by the NJ501-□□20/NJ101-□020 are as follows.

Item	Description			
	NJ501-1□20	NJ101-□020		
Supported port	Built-in EtherNet/IP port			
Supported DB *1*2	Microsoft Corporation: SQL Server 2012/2014/2016/2017/2019/2022 Oracle Corporation: Oracle Database 11g /12c/18c/19c/21c/23ai (23c) MySQL Community Edition 5.6/5.7/8.0 *3 International Business Machines Corporation (IBM): DB2 for Linux, UNIX and Windows 9.7/10.1/10.5/11.1 *4 Firebird Foundation Incorporated: Firebird 2.5 *4 The PostgreSQL Global Development Group: PostgreSQL 9.4/9.5/9.6/10/11/12/13/14/15/16 *4			
Number of DB Connections (Number of databases that can be connected at the same time)	3 connections max. *5	1		
Instruction	Supported operations	The following operations can be performed by executing DB Connection Instructions in the NJ/NX-series CPU Units. Inserting records (INSERT), Updating records (UPDATE), Retrieving records (SELECT), Deleting records (DELETE), Execute Stored Procedure *6, and Execute Batch Insert *6		
	Max. number of instructions for simultaneous execution	32		
	Max. number of columns in an INSERT operation	SQL Server: 1,024 Oracle: 1,000 DB2: 1,000 MySQL: 1,000 Firebird: 1,000 PostgreSQL: 1,000		
	Max. number of columns in an UPDATE operation	SQL Server: 1,024 Oracle: 1,000 DB2: 1,000 MySQL: 1,000 Firebird: 1,000 PostgreSQL: 1,000		
	Max. number of columns in a SELECT operation	SQL Server: 1,024 Oracle: 1,000 DB2: 1,000 MySQL: 1,000 Firebird: 1,000 PostgreSQL: 1,000		
	Max. number of records in the output of a SELECT operation	65,535 elements, 4 MB	65,535 elements, 2 MB	
	Stored procedure call *6	Supported databases	<ul style="list-style-type: none"> • SQL Server • Oracle Database • MySQL Community Edition • PostgreSQL *7 	
		Argument (Sum of IN, OUT and INOUT)	Up to 256 variables *8	
		Return value	One variable	
		Result set	Supported	
Spool function		Not supported		
Batch insert execution *6	Supported databases	<ul style="list-style-type: none"> • SQL Server • Oracle Database • MySQL Community Edition • PostgreSQL *7 		
	Supported data size	Less than 1,000 columns and upper limit of structure variable size or less *9		
	Spool function	Not supported		
Max. number of DB Map Variables for which a mapping can be connected *10	SQL Server: 60 Oracle: 30 DB2: 30 *4 MySQL: 30 Firebird: 15 *4 PostgreSQL: 30 *4	SQL Server: 15 Oracle: 15 DB2: 15 MySQL: 15 Firebird: 15 PostgreSQL: 15		
Run mode of the DB Connection Service	Operation Mode or Test Mode <ul style="list-style-type: none"> • Operation Mode: When each instruction is executed, the service actually accesses the DB. • Test Mode: When each instruction is executed, the service ends the instruction normally without accessing the DB actually. 			
Spool function	Used to store SQL statements when an error occurred and resend the statements when the communications are recovered from the error.			
Spool capacity	1 MB *11	192 KB *11		
Operation Log function	The following three types of logs can be recorded. <ul style="list-style-type: none"> • Execution Log: Log for tracing the executions of the DB Connection Service. • Debug Log: Detailed log for SQL statement executions of the DB Connection Service. • SQL Execution Failure Log: Log for execution failures of SQL statements in the DB. 			
DB Connection Service shutdown function	Used to shut down the DB Connection Service after automatically saving the Operation Log files into the SD Memory Card.			
Encrypted Communication	Supported databases	<ul style="list-style-type: none"> • SQL Server • Oracle Database • MySQL Community Edition • PostgreSQL *7 		
	TLS Ver.	TLS 1.2		

- *1. SQL Server 2014, Oracle Database 12c and PostgreSQL 9.4 are supported by the DB Connection Service Version 1.02 or higher.
SQL Server 2016, My SQL 5.7, DB2 11.1 and Postgre SQL 9.5/9.6 are supported by the DB Connection Service Version 1.03 or higher.
SQL Server 2017 is supported by the DB Connection Service Version 1.04 or higher.
Oracle Database 18c, MySQL Community Edition 8.0 and PostgreSQL 10 are supported by the DB Connection Service Version 2.00 or higher.
You cannot use Oracle 10g with the DB Connection Service version 2.00 or higher.
SQL Server 2019, Oracle Database 19c and PostgreSQL 11/12/13 are supported by the DB Connection Service Version 2.01 or higher.
SQL Server 2022, Oracle Database 21c/23ai (23c) and PostgreSQL 14/15/16 are supported by the DB Connection Service Version 2.04 or higher.
- *2. Connection to the DB on the cloud is not supported.
- *3. The supported storage engines of the DB are InnoDB and MyISAM.
- *4. NJ501-4320 is not supported.
- *5. When two or more DB Connections are established, the operation cannot be guaranteed if you set different database types for the connections.
- *6. The function is available for the DB Connection Service Version 2.00 or higher.
- *7. The NJ501-4320 does not support PostgreSQL.
- *8. Depends on members of a structure.
- *9. Constrained by the memory capacity for variables. See the specifications for the memory capacity for variables.
- *10. Even if the number of DB Map Variables has not reached the upper limit, the total number of members of structures used as data type of DB Map Variables is 10,000 members max.
- *11. Refer to "NJ/NX-series Database Connection CPU Units User's Manual(W527)" for the information.

Note: The extended support for databases has ended for the following DB versions.
Please consider replacing the current database with a new version.

Item	Discription
Microsoft Corporation: SQL Server	2008/2008R2
Oracle Corporation: Oracle Database	10g
Oracle Corporation: MySQL Community Edition	5.1/5.5
International Business Machines Corporation (IBM): DB2 for Linux, UNIX and Windows	9.5
Firebird Foundation Incorporated: Firebird	2.1
The PostgreSQL Global Development Group: PostgreSQL	9.2/9.3

NJ-Series

Function Specifications of SECS/GEM CPU Units

Besides functions of the NJ501-1300, functions supported by the NJ501-1340 are as follows.

Item	Description
Supported port	Built-in EtherNet/IP port
Supported standard *1	The Unit conforms to the following SEMI standards: E37-0303, E37.1-0702, E5-0707, and E30-0307
Fundamental GEM requirement	State Model, Equipment Processing State, Host-initiated S1, F13/F14 Scenario, Event Notification, On-Line Identification, Error Message, Control (Operator Initiated), Documentation
Additional GEM capability	Establish Communications, Dynamic Event Report Configuration, Variable Data Collection, Trace Data Collection, Status Data Collection, Alarm Management, Remote Control, Equipment Constant, Process Recipe Management *1, Material Movement, Equipment Terminal Service, Clock, Limit Monitoring, Spooling *2, Control (Host Initiated)
User-defined message	You can create non-GEM compliant communications messages and have host communications.
GEM specific instruction	The Unit supports 29 instructions to perform the following: <ul style="list-style-type: none"> • Changing the GEM Service status. • Setting HSMS communications. • Reporting events and reporting alarms. • Acknowledging host commands and enhanced remote commands. • Changing equipment constants. • Uploading and downloading process programs. • Sending and acknowledging equipment terminal messages. • Requesting to change time. • Sending user-defined messages. • Getting SECS communications log.
GEM Service log *2	Can record the following information. <ul style="list-style-type: none"> • HSMS communications log: Keeps log of HSMS communications operations. • SECS message log: Keeps log of SECS-II communications messages. • Execution log: Keeps log of executions of GEM instructions.
Shutting down the GEM Service	Saves the pool data and GEM Service log records into an SD Memory Card and ends the GEM Service.

*1. E42 recipes, large process programs, and E139 recipes are not supported.

*2. The capability is not available when no SD Memory Card is mounted.

Conformance to Fundamental GEM Requirements and Additional Capabilities

Fundamental GEM requirements	GEM-compliant	Additional capabilities	GEM-compliant
State Model	Yes	Establish Communications	Yes
Equipment Processing State		Dynamic Event Report Configuration	
Host-initiated S1, F13/F14 Scenario		Variable Data Collection	
Event Notification		Trace Data Collection	
On-Line Identification		Status Data Collection	
Error Message		Alarm Management	
Control (Operator Initiated)		Remote Control	
Documentation		Equipment Constant	
		Process Recipe Management	Process program: Yes E42 recipes: No E139 recipes: No
		Material Movement	Yes
		Equipment Terminal Service	
		Clock	
		Limit Monitoring	
		Spooling	
		Control (Host Initiated)	

Function Specifications of NJ Robotics CPU Units

Besides functions of the NJ501-1□00, functions supported by the NJ501-4□□□ are as follows.

Item				NJ501-				
				4500	4400	4300	4310	4320
Robot control functions	Axes groups	Multi-axes coordinated control	Conveyer tracking	The robot is moved in synchronization with the conveyor during the conveyor tracking operation.				
		Auxiliary functions for multi-axes coordinated control	Kinematics Setting	Set parameters for robot operation, such as arm length of Delta3 robot.				
	Auxiliary functions	Monitoring functions	Work space function	Set the coordinate values for workspace check and check the workspace during operation.				

Function Specifications of NC Integrated Controller

Besides functions of the NJ501-1□00, functions supported by the NJ501-5300 are as follows.

Item		NJ501-					
		5300					
Numerical Control	CNC coordinate system	Axes types		Positioning axis, Spindle axis			
		Control modes	Positioning axis	Position control			
			Spindle axis	Velocity control			
		Positions that can be managed		Absolute position (command), absolute position (actual), program position, remaining travel distance			
		NC program execution	Execute		Executes the NC program.		
			Reset		Interrupt NC program		
			Single step execution		Executes the NC program by block.		
			Back trace		Executes back trace of interpolation pass.		
			Feed hold / Feed hold reset		Temporarily stops the NC program, and restarts it.		
			Optional stop		Stops the NC program with optional signal.		
			Optional block stop		Skips one block of the NC program with optional signal.		
			Dry run		Runs operation from the NC program.		
			Machine lock		Locks each axis operation during execution of the NC program.		
			Auxiliary lock		Locks M code output.		
			Override		Overrides the feed rate and spindle velocity.		
		G Code	Position control	Rapid Positioning	Rapid feed of each CNC motor according to the motor setting.		
				Linear interpolation	Interpolates linearly.		
				Circular interpolation	Interpolates circularly, helically, spirally, or conically.		
				Skip function	Rapid feed until an external signal is input.		
			Return to reference point		Returns to a specified position on the machine.		
			Canned cycle	Rigid tap	Performs tapping machining.		
			Feed function	Exact stop		Temporarily prevents blending of positioning operations before and after an exact stop direction.	
				Exact stop mode		Mode in which anteroposterior positioning operations are not blended.	
				Continuous-path mode		Mode in which anteroposterior positioning operations are blended.	
				Dwell		Waits for the specified period of time.	
			Coordinate system selection	Machine Coordinate System		The coordinate system uses the machine home position as the home of the system.	
				Work Coordinate System		The coordinate system has work offset for the Machine Coordinate System.	
				Local Coordinate System		The coordinate system has additional offset for the Work Coordinate System.	
			Auxiliary for coordinate system	Absolute/relative selection		Specifies manipulated variable absolutely, or switches to the relative setting.	
				Metric/inch selection		Selects metric or inch as the orthogonal axes unit system.	
				Scaling		Scales the current coordinates of the orthogonal axes.	
				Mirroring		Mirrors the current coordinates for the specified orthogonal axes.	
			Tool functions	Rotation		Rotate the current coordinates around the coordinates of the specified axis.	
				Cutter compensation	Compensation of the tool edge path according to the tool radius.		
			M code	Tool length compensation		Compensation of tool center point path according to the tool length.	
				M code/M code reset			Outputs M codes, and interlocks with sequence control program using reset.
				Spindle axis	CW/CCW/Stop		Outputs/stops velocity commands in velocity loop control mode.
			Orientation		Stops spindle axis to the specified phase by setting up feed back loop.		
		Subroutine call			Calls a subroutine of the NC program.		
		NC programming	Arithmetic operation			Performs a calculation in the NC program.	
Branch control			Branches on condition in the NC program.				
User variables			Memory area in the NC program used for processing such as data calculation.				
P variable			System global memory area common to CNC coordinate systems				
Q variable			Global system area unique to each CNC coordinate system				
Auxiliary control functions	L variable			Memory area that can be used as the primary area during execution of the NC program			
	Error reset			Function that resets errors or CNC coordinate system and CNC motor.			
	Immediate stop			Function that stops all the CNC motors of the CNC coordinate system.			

Item		NJ501-				
		5300				
Numerical Control	CNC motor	Positions that can be managed		Commanded positions and actual positions.		
		Position control	Absolute positioning		Positioning is performed for a target position that is specified using an absolute value.	
			Relative positioning		Positioning is performed for a specified travel distance from the command current position.	
			Cyclic positioning		A commanded position is output at each control period in Position Control Mode.	
		Spindle control	CW/CCW/Stop		Outputs/stops velocity commands in velocity loop control mode.	
		Manual operation	Powering the Servo		The Servo in the servo driver is turned ON to enable CNC motor operation.	
			Jogging		A CNC motor is jogged at a specified target velocity.	
		Auxiliary control functions	Homing		A CNC motor is operated, and the limit signals, home proximity signal, and home signal are used to define home.	
			Immediate stop		A CNC motor is stopped immediately.	
		CNC motor compensation table	Ball screw compensation		Pitch error compensation for one-dimensional ball screw.	
			Cross-axis compensation		Compensation of one-dimensional cross-axis.	
			Editing the CNC motor compensation table		Edit using sequence control program. (Read/write)	
		Auxiliary functions	In-position check		You can set an in-position range and in-position check time to confirm when positioning is completed.	
			Stop method		You can set the stop method to the immediate stop input signal or limit input signal.	
			Monitoring functions	Software limits		Monitors the movement range of a CNC motor.
				Following error		Monitors the error between the command current value and the actual current value for a CNC motor.
			Absolute encoder support		You can use an OMRON 1S-series Servomotor or G5-series Servomotor with an Absolute Encoder to eliminate the need to perform homing at startup.	
			Input signal logic inversion		You can inverse the logic of immediate stop input signal, positive limit input signal, negative limit input signal, or home proximity input signal.	
		External interface signals		The Servo Drive input signals listed on the right are used. Home signal, home proximity signal, positive limit signal, negative limit signal, immediate stop signal, and interrupt input signal.		
	Common items	Parameters	Changing CNC coordinate system and CNC motor parameters	You can access and change the CNC coordinate system and CNC motor parameters from the user program.		

Function Specifications of Robot integrated CPU Units

Besides functions of the NJ501-1□□0, functions supported by the NJ501-R□□0 are as follows.

Item		Description	
		NJ501-R□□0	
Robot Control	Number of robots	Maximum number of robots	8 robots
	Motion Operation	Basic operation	Joint interpolation operation, Linear motion, Arc motion, Jog motion
		Coordinate system of Tool	Descent (APPRO), Rising (DEPART), Tool alignment (ALIGN)
		Joint motion	Each joint operation (DRIVE)
		Application	Pick or Place
		Continous-path motion	ON, OFF
		Deceleration Stop	Braking current motion
		Home position	Move to home position (READY)
	Motion Modifiers	Speed of the robot	Velocity profile, Velocity, Acceleration, Deceleration, Minimum operation time
		Unit of speed	Ratio for maximum velocity, [mm/s], [inch/s]
		Arm configuration	ABOVE/BELOW, LEFTY/RIGHTY, FLIP/NOFLIP
		Hardware servo	High accuracy/Low accuracy
		Axis of rotation	Rotation Range, Rotation Range Over Error
		Position Deviation	Pending position deviation cancellation
	Latching	Robot position	You can read the robot position in the V+ program when a latch signal occurred.
		Local encoder	You can read the counter value of encoder that is connected to the encoder input port of OMRON robot in the V+ program when a latch signal occurred.
	Other functions	Coordinate system	World coordinate system, Tool coordinate system, Conversion from/to NJ Robotics function coordinate system
		Position variable	Conversion, Relative conversion, High accuracy position
		Robot tool	Tool offset setting
		End effector operation	Open/Close/Loosen Gripper
		Conveyor tracking	Belt variable, Nominal transformation, Encoder scaling factor, Encoder offset, Belt window, Belt relative motion
Stop		Specified time stop (DELAY)	

NJ-Series

Version Information

Unit Versions and Programming Devices (NJ-series CPU Units)

Refer to *NJ-series CPU Unit Hardware User's Manual (W500)*.

Unit Versions, DBCon Versions and Programming Devices (Database Connection CPU Units)

Refer to *NJ/NX-series Database Connection CPU Units User's Manual (W527)*.

Unit Versions, Robot Versions and Programming Devices (NJ Robotics CPU Units)

Refer to *NJ-series Robotics CPU Units User's Manual (W539)*.

Unit Versions and Programming Devices (NC Integrated Controller)

Refer to *NJ/NY-series NC Integrated Controller User's Manual (O030)*.

Unit Versions, Robot Control Versions and Programming Devices (Robot Integrated CPU Units)

Refer to *NJ-series Robot Integrated CPU Unit User's Manual (O037)*.

Relationship between Hardware Revisions of CPU Units and Sysmac Studio Versions

Refer to *NJ-series CPU Unit Hardware User's Manual (W500)*.

Functions That Were Added or Changed for Each Unit Version and Sysmac Studio version

Refer to *NJ-series CPU Unit Hardware User's Manual (W500)*.

Performance Improvements for Unit Version Upgrades

Refer to *NJ-series CPU Unit Hardware User's Manual (W500)*.

Components and Functions

CPU Unit

NJ□01-□□□□

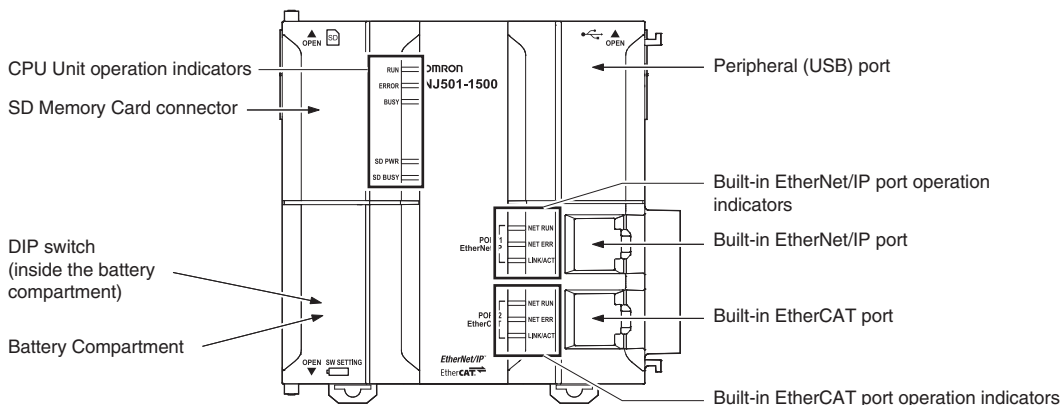

Power Supply Unit

NJ-PA3001

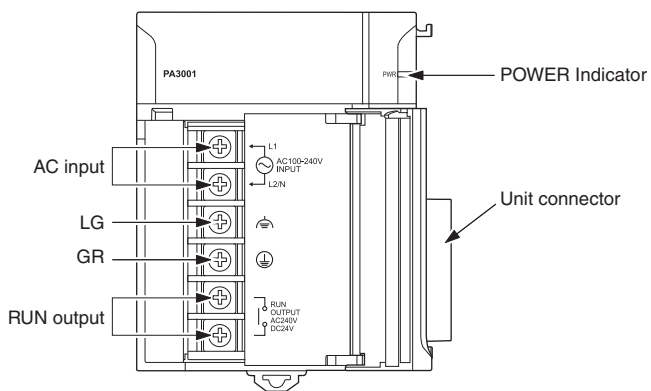

NJ-PD3001

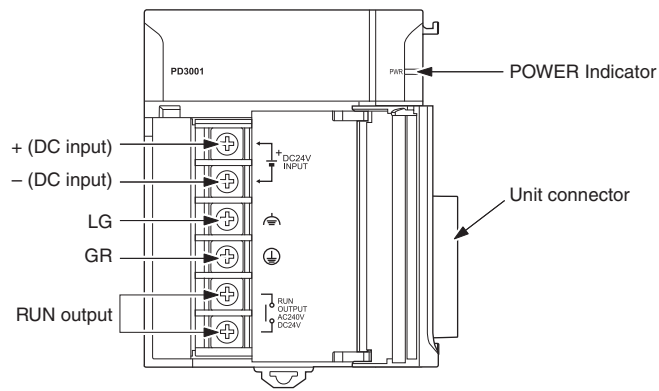

NJ-Series

Unit Configuration

NJ-Series CPU Racks

A NJ-Series CPU Rack consists of a CPU Unit, Power Supply Unit, Configuration Units (Basic I/O Units, Special I/O Units, and CPU Bus Units), and an End Cover.

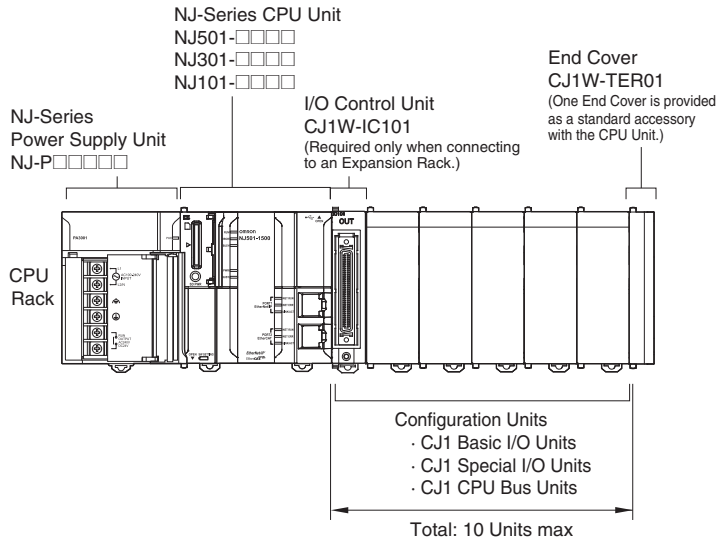

Even though the NJ-Series Controllers do not have Backplanes, the term “slot” still used to refer to the location of Units. Slot numbers are assigned in order to Units from left to right on the CPU Rack (slot 0, slot 1, slot 2, etc.).

Required Units

Rack	Unit name	Required number of Units
CPU Rack	NJ-Series Power Supply Unit	1
	NJ-Series CPU Unit	1
	I/O Control Unit	Required only for mounting to an Expansion Rack. Mount the I/O Control Unit immediately to the right of the CPU Unit.
	Number of Configuration Units	10 max. (Same for all models of CPU Unit.) (The number of Basic I/O Units, Special I/O Units, and CPU Bus Units can be varied. The number does not include the I/O Control Unit.)
	End Cover	1 (Included with CPU Unit.)
	NJ-Series SD Memory Card	Install as required.

Types of Configuration Units

In the NJ-Series, Configuration Units are classified into the following three types. The number of Racks differs depending on the type.

Type	Appearance (example)	Description	Unit recognition method	Max. Units mountable per CPU Unit
Basic I/O Units		Units with contact inputs and contact outputs.	Recognized by the CPU Unit according to the position of the Rack and slot.	A maximum of 40 Units can be mounted.
Special I/O Units		Special I/O Units provide more advanced functions than do Basic I/O Units, including I/O other than contact inputs and contact outputs. Examples of Special I/O Units are Analog I/O Units and High-speed Counter Units. They differ from CPU Bus Units (including Network Communications Units) in having a smaller area for exchanging data with the CPU Unit.	Recognized by the CPU Unit according to the unit number (0 to 95) set with the rotary switches on the front panel.	A maximum of 40 Units can be connected. (Multiple unit numbers are allocated per Unit, depending on the model and settings.)
CPU Bus Units		CPU Bus Units exchange data with the CPU Unit via the CPU Bus. Examples of CPU Bus Units are Network Communications Units and Serial Communications Units. They differ from Special I/O Units in having a larger area for exchanging data with the CPU Unit.	Recognized by the CPU Unit according to the unit number (0 to F) set with the rotary switch on the front panel.	A maximum of 16 Units can be mounted.

NJ-Series Expansion Racks

A NJ-Series Expansion Rack consists of a Power Supply Unit, an I/O Interface Unit, Configuration Units (Basic I/O Units, Special I/O Units, and CPU Bus Units), and an End Cover.

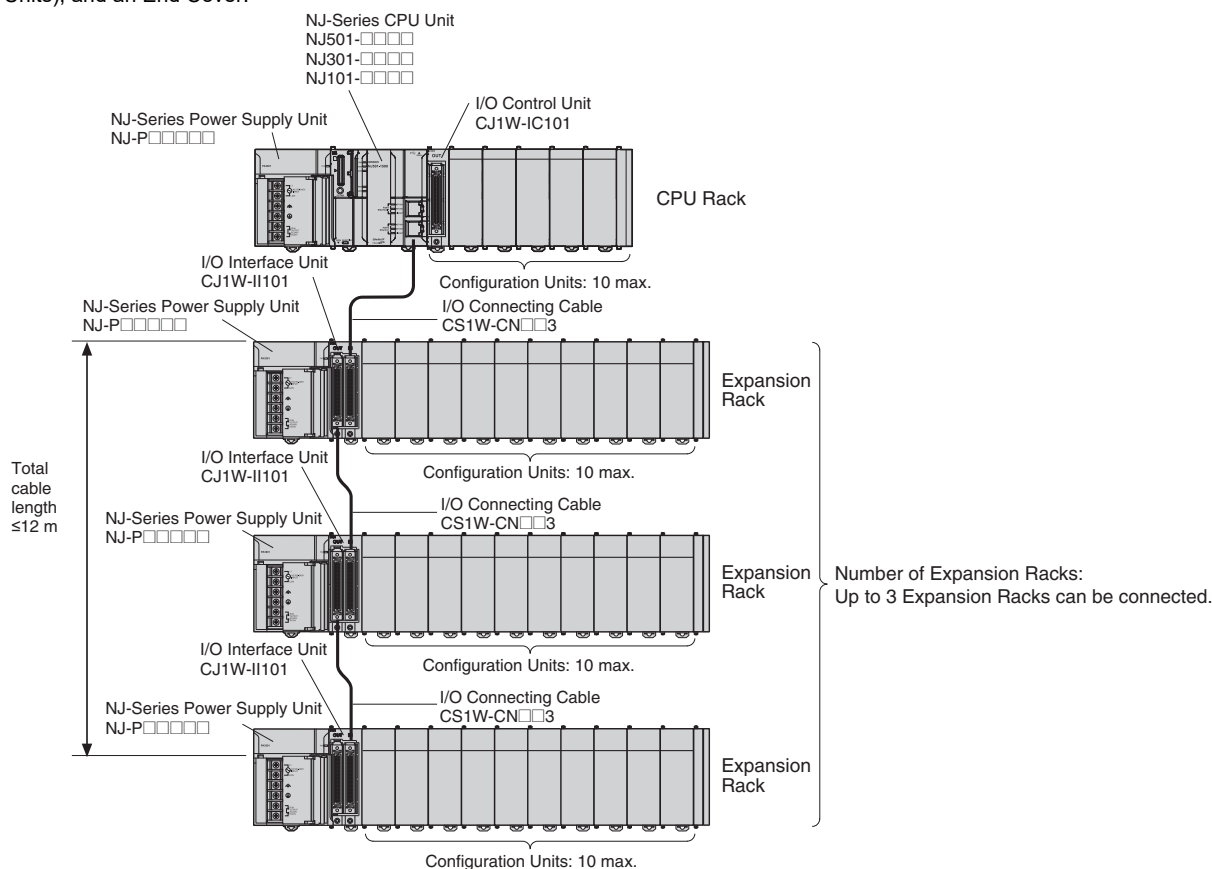

Required Units

Rack	Unit name	Required number of Units
CPU Rack	I/O Control Unit	One Unit. Required only when an Expansion Rack is used. Mount the I/O Control Unit immediately to the right of the CPU Unit. *1
Expansion Rack	Power Supply Unit	One Unit
	I/O Interface Unit	One Unit. Mount the I/O Interface Unit immediately to the right of the Power Supply Unit. *2
	Number of Configuration Units	Ten Units max. (The number of Basic I/O Units, Special I/O Units, and CPU Bus Units can be varied. This number does not include the I/O Interface Unit.)
	End Cover	One (Included with the I/O Interface Unit.)

*1 Mounting the I/O Control Unit in any other location may cause faulty operation.

*2. Mounting the I/O Interface Unit in any other location may cause faulty operation.

Configuration Units

Maximum Number of Configuration Units That Can Be Mounted

CPU Unit	Model	Total Units	No. of Units on CPU Rack	No. of Expansion Racks
NJ-Series CPU Unit	NJ501-□□□□	40	10 per Rack	3 Racks x 10 Units
	NJ301-□□□□			
	NJ101-□□□□			

Note: It may not be possible to mount the maximum number of configuration Units depending on the specific Units that are mounted. Refer to the next page for details.

Number of mountable units per Configuration Unit

Basic I/O Units, Special I/O Units, and CPU Bus Units of the CJ-Series are used as Configuration Units of the NJ-Series. All Basic I/O Units are useable. Not all Special I/O Units and CPU Bus Units can be used. Units that can be used are shown in the list. In addition, note that the number of units that can be connected to one CPU vary depending on the units.

NJ-Series

Dimensions

(Unit: mm)

CPU Units NJ□01-□□□□

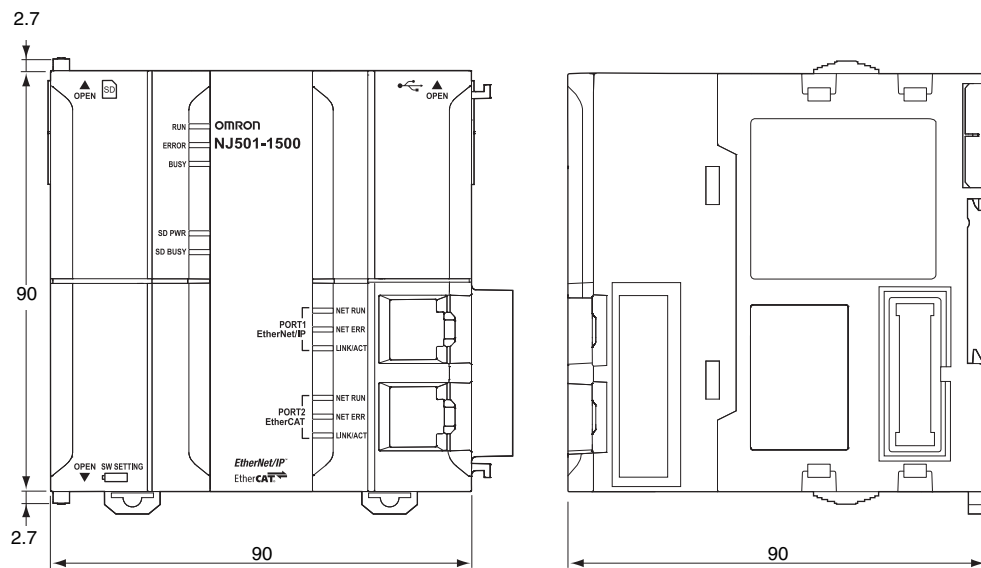

Power Supply Units NJ-PA3001 NJ-PD3001

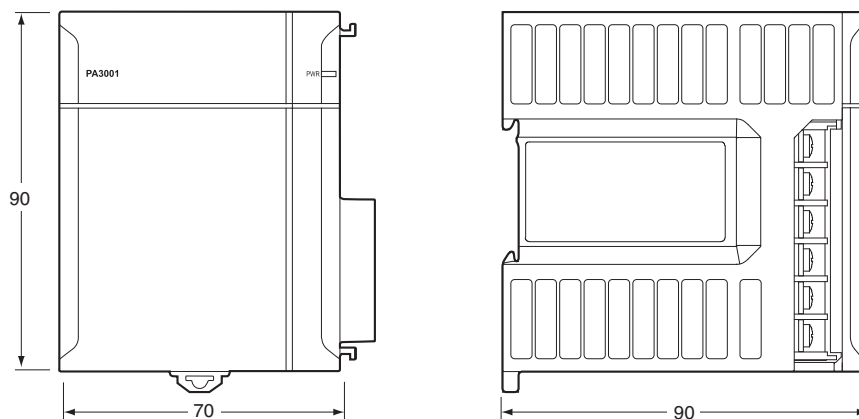

End Cover (included with CPU Units) CJ1W-TER01

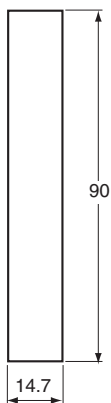

Related Manuals

Cat. No.	Model number	Manual	Application	Description
W513	NJ501-□□□□ NJ301-□□□□ NJ101-□□□□	NJ Series Startup Guide (CPU Unit)	Using the NJ-series CPU Unit for the first time	The startup procedures for using an NJ-series CPU Unit and the basic operating instructions for the Sysmac Studio are described with a simple sequence control example.
W514	NX701-□□□□ NX1P2-□□□□ NJ501-□□□□ NJ301-□□□□ NJ101-□□□□	NJ/NX-series Startup Guide (Motion Control)	Using the motion control function module of the NJ/NX-series for the first time	The startup procedures for setting axis parameters and performing simple one-axis positioning and two-axis linear interpolation with an NJ/NX-series CPU Unit and the operating instructions for the Sysmac Studio are described.
W500	NJ501-□□□□ NJ301-□□□□ NJ101-□□□□	NJ-series CPU Unit Hardware User's Manual	Learning the basic specifications of the NJ-series CPU Units, including introductory information, designing, installation, and maintenance. Mainly hardware information is provided.	An introduction to the entire NJ-series system is provided along with the following information on a Controller built with a CPU Unit. <ul style="list-style-type: none"> • Features and system configuration • Introduction • Part names and functions • General specifications • Installation and wiring • Maintenance and inspection
W501	NX701-□□□□ NX502-□□□□ NX102-□□□□ NX1P2-□□□□ NJ501-□□□□ NJ301-□□□□ NJ101-□□□□	NJ/NX-series CPU Unit Software User's Manual	Learning how to program and set up an NJ/NX-series CPU Unit. Mainly software information is provided.	The following information is provided on a Controller built with an NJ/NX-series CPU Unit. <ul style="list-style-type: none"> • CPU Unit operation • CPU Unit features • Initial settings • Programming language specifications and programming with the IEC 61131-3 standard.
W507	NX701-□□□□ NX502-□□□□ NX102-□□□□ NX1P2-□□□□ NJ501-□□□□ NJ301-□□□□ NJ101-□□□□	NJ/NX-series CPU Unit Motion Control User's Manual	Learning about motion control settings and programming concepts	The settings and operation of the CPU Unit and programming concepts for motion control are described.
W505	NX701-□□□□ NX502-□□□□ NX102-□□□□ NX1P2-□□□□ NJ501-□□□□ NJ301-□□□□ NJ101-□□□□	NJ/NX-series CPU Unit Built-in EtherCAT Port User's Manual	Using the built-in EtherCAT port on an NJ/NX-series CPU Unit	Information on the built-in EtherCAT port is provided. This manual provides an introduction and provides information on the configuration, features, and setup.
W539	NJ501-4□□□ NJ501-R□□□	NJ-series NJ Robotics CPU Unit User's Manual	Controlling robots with NJ-series CPU Units.	Describes the functionality to control robots.
O037	NJ501-R□□□	NJ-series Robot Integrated CPU Unit User's Manual	Using the NJ-series Robot Integrated CPU Unit.	Describes the settings and operation of the CPU Unit and programming concepts for OMRON robot control.
W527	NX701-□□20 NX502-1□00 NX102-□□20 NJ501-□□20 NJ101-□□20	NJ/NX-series Database Connection CPU Units User's Manual	Learning about the functions and application procedures of the NJ/NX-series DB Connection function.	Describes the functions and application procedures of the NJ/NX-series DB Connection function.
W528	NJ501-1340	NJ-series SECS/GEM CPU Unit User's Manual	Learning about the SECS/GEM CPU Unit and how to use it.	Functional outline, GEM instructions, settings with the GEM Configurator and so on are provided.
O030	NJ501-5300 NY532-5400	NJ/NY-Series NC Integrated Controller User's Manual	For numerical control with NJ/NY-series	Describes the numerical control function.
W506	NX701-□□□□ NX502-□□□□ NX102-□□□□ NX1P2-□□□□ NJ501-□□□□ NJ301-□□□□ NJ101-□□□□	NJ/NX-series CPU Unit Built-in EtherNet/IP Port User's Manual	Using the built-in EtherNet/IP port on an NJ/NX-series CPU Unit	Information on the built-in EtherNet/IP port is provided. Information is provided on the basic setup, tag data links, FINS communications (non-disclosure), and other features.
W588	NX102-□□□□ NX701-1□□□ NX502-1□00 NJ501-1□00	NJ/NX-series CPU Unit OPC UA User's Manual	Using the OPC UA.	Describes the OPC UA.
W502	NX701-□□□□ NX502-□□□□ NX102-□□□□ NX1P2-□□□□ NJ501-□□□□ NJ301-□□□□ NJ101-□□□□	NJ/NX-series Instructions Reference Manual	Learning about the specifications of the instruction set that is provided by OMRON	The instructions in the instruction set (IEC 61131-3 specifications) are described.
W508	NX701-□□□□ NX502-□□□□ NX102-□□□□ NX1P2-□□□□ NJ501-□□□□ NJ301-□□□□ NJ101-□□□□	NJ/NX-series Motion Control Instructions Reference Manual	Learning about the specifications of the motion control instructions that are provided by OMRON	The motion control instructions are described.
W503	NX701-□□□□ NX502-□□□□ NX102-□□□□ NX1P2-□□□□ NJ501-□□□□ NJ301-□□□□ NJ101-□□□□	NJ/NX-series Troubleshooting Manual	Learning about the errors that may be detected in an NJ/NX-series Controller.	Concepts on managing errors that may be detected in an NJ/NX-series Controller and information on individual errors are described.

NJ-Series

Cat. No.	Model number	Manual	Application	Description
W504	SYSMAC-SE2□□□□	Sysmac Studio Version 1 Operation Manual	Learning about the operating procedures and functions of the Sysmac Studio.	Describes the operating procedures of the Sysmac Studio.
O031	NJ501-5300 NY532-5400	NJ/NY-series G code Instruction Reference Manual	Learning about detailed specifications of the G code/M code instructions.	This section describes G code/M code instructions in detail.
W589	SYSMACSE2□□□□ SYSMAC-TA4□□□□	Sysmac Studio Project Version Control Function Operation Manual	Learning the overview of the Sysmac Studio project version control function and how to use it.	The manual outlines the Sysmac Studio project version control function, and describes how to install, basic operation, and how to operate its major functions.
O032	SYSMAC-RTNC0□□□□D	CNC Operator Operation Manual	Learning the overview of CNC Operator and how to use it.	Describes the CNC Operator, installation procedure, basic operation, connection operation, and operating procedures for main functions.
W595	SYSMAC-SE2□□□□ SYSMAC-SE200D-64	Sysmac Studio Robot Integrated System Building Function with Robot Integrated CPU Unit Operation Manual	Learning about the operating procedures and functions of the Sysmac Studio to configure Robot Integrated System using Robot Integrated CPU Unit.	Describes the operating procedures of the Sysmac Studio for Robot Integrated CPU Unit.
W621	SYSMAC-SE2□□□□ SYSMAC-SE200D-64	Sysmac Studio Robot Integrated System Building Function with IPC Application Controller Operation Manual	Learning about the operating procedures and functions of the Sysmac Studio to configure Robot Integrated System using IPC Application Controller.	Describes the operating procedures of the Sysmac Studio for IPC Application Controller.
W490 W498 W491 Z317 W492 W494 W497 W495 W493	CJ1W-□□□□□	CJ-series Special Unit Manuals for NJ-series CPU Unit	Learning how to connect CJ-series Units	The methods and precautions for using CJ-series Units with an NJ-series CPU Unit are described, including access methods and programming interfaces. Manuals are available for the following Units. Analog I/O Units, Insulated-type Analog I/O Units, Temperature Control Units, ID Sensor Units, High-speed Counter Units, and DeviceNet Units, EtherNet/IP Units, CompoNet Master Units
Y128		Vision & Robot Integrated Simulation Startup Guide	Learning about the operating procedures of Vision & Robot integrated simulation.	Describes the operating procedures of Vision & Robot integrated simulation.
Y213		Vision & Robot Integrated Simulation Technology Introduction Guide (Calibration Parameter)	Learning about the calibration parameters created using the 3D Equipment Model Creation Wizard for the Vision & Robot integrated simulation.	Describes calibration parameters created using the 3D Equipment Model Creation Wizard for the Vision & Robot integrated simulation.
Z368	SYSMAC-SE20□□□ SYSMAC-RA401L	Vision Sensor FH Series Conveyor Tracking Application Programming Guide	Learning about the setup procedure of the wizard style calibration for cameras, robots, or conveyors.	Describes how to configure and operate Conveyor Tracking Calibration Wizard on Sysmac Studio on FH Sensor Controllers.
Z369	NJ501-4□□□□ R88D-KN□-ECT FH-1□□□□ FH-3□□□□	Vision Sensor FH Series Operation Manual Sysmac Studio Calibration Plate Print Tool	Learning about the setup procedure for printing the Pattern on a Calibration Plate used for calibration for cameras and robots on Sysmac Studio.	Describes how to configure and operate Calibration Plate Print Tool on Sysmac Studio on FH Sensor Controllers.
Z370		Vision Sensor FH Series Operation Manual Sysmac Studio Conveyor Tracking Calibration Wizard Tool	Learning about the setting procedure of sample macros for conveyor tracking.	Describes the setting procedure of sample macros used for applications of conveyor tracking on FH Sensor Controllers.
Z371		Vision Sensor FH Series Operation Manual Sysmac Studio Conveyor Panorama Display Tool	Learning about the setup procedure of panorama display for image capture of targets on conveyors.	Describes how to configure and operate the Conveyor Panorama Display tool on Sysmac Studio on FH Sensor Controllers.

Applicable Models for Cable Redundancy Function

For more information on applicable models of Cable Redundancy function, refer to the Applicable Models of Cable Redundancy Function (Cat. No. R200).

Sysmac is a trademark or registered trademark of OMRON Corporation in Japan and other countries for OMRON factory automation products.

Microsoft, Windows, Windows Vista and SQL Server are registered trademarks of Microsoft Corporation in the United States and other countries.

Oracle, Oracle Database and MySQL are trademarks or registered trademarks of Oracle Corporation and/or its affiliates in the United States and other countries.

IBM and DB2 are trademarks or registered trademarks of International Business Machines Corp., registered in the United States and other countries.

SEMI® is a trademark or registered trademark of Semiconductor Equipment and Materials International in the United States and other countries.

EtherCAT® is a registered trademark of Beckhoff Automation GmbH for their patented technology.

EtherNet/IP™ and DeviceNet™ are trademarks of ODVA.

OPC UA is trademark of the OPC Foundation.

This product includes software developed by the OpenSSL Project for use in the OpenSSL Toolkit. (<http://www.openssl.org/>)

This product includes cryptographic software written by Eric Young (eay@cryptsoft.com).

Other company names and product names in this document are the trademarks or registered trademarks of their respective companies.

Terms and Conditions Agreement

Read and understand this catalog.

Please read and understand this catalog before purchasing the products. Please consult your OMRON representative if you have any questions or comments.

Warranties.

- (a) Exclusive Warranty. Omron's exclusive warranty is that the Products will be free from defects in materials and workmanship for a period of twelve months from the date of sale by Omron (or such other period expressed in writing by Omron). Omron disclaims all other warranties, express or implied.
- (b) Limitations. OMRON MAKES NO WARRANTY OR REPRESENTATION, EXPRESS OR IMPLIED, ABOUT NON-INFRINGEMENT, MERCHANTABILITY OR FITNESS FOR A PARTICULAR PURPOSE OF THE PRODUCTS. BUYER ACKNOWLEDGES THAT IT ALONE HAS DETERMINED THAT THE PRODUCTS WILL SUITABLY MEET THE REQUIREMENTS OF THEIR INTENDED USE.

Omron further disclaims all warranties and responsibility of any type for claims or expenses based on infringement by the Products or otherwise of any intellectual property right. (c) Buyer Remedy. Omron's sole obligation hereunder shall be, at Omron's election, to (i) replace (in the form originally shipped with Buyer responsible for labor charges for removal or replacement thereof) the non-complying Product, (ii) repair the non-complying Product, or (iii) repay or credit Buyer an amount equal to the purchase price of the non-complying Product; provided that in no event shall Omron be responsible for warranty, repair, indemnity or any other claims or expenses regarding the Products unless Omron's analysis confirms that the Products were properly handled, stored, installed and maintained and not subject to contamination, abuse, misuse or inappropriate modification. Return of any Products by Buyer must be approved in writing by Omron before shipment. Omron Companies shall not be liable for the suitability or unsuitability or the results from the use of Products in combination with any electrical or electronic components, circuits, system assemblies or any other materials or substances or environments. Any advice, recommendations or information given orally or in writing, are not to be construed as an amendment or addition to the above warranty.

See <http://www.omron.com/global/> or contact your Omron representative for published information.

Limitation on Liability: Etc.

OMRON COMPANIES SHALL NOT BE LIABLE FOR SPECIAL, INDIRECT, INCIDENTAL, OR CONSEQUENTIAL DAMAGES, LOSS OF PROFITS OR PRODUCTION OR COMMERCIAL LOSS IN ANY WAY CONNECTED WITH THE PRODUCTS, WHETHER SUCH CLAIM IS BASED IN CONTRACT, WARRANTY, NEGLIGENCE OR STRICT LIABILITY.

Further, in no event shall liability of Omron Companies exceed the individual price of the Product on which liability is asserted.

Suitability of Use.

Omron Companies shall not be responsible for conformity with any standards, codes or regulations which apply to the combination of the Product in the Buyer's application or use of the Product. At Buyer's request, Omron will provide applicable third party certification documents identifying ratings and limitations of use which apply to the Product. This information by itself is not sufficient for a complete determination of the suitability of the Product in combination with the end product, machine, system, or other application or use. Buyer shall be solely responsible for determining appropriateness of the particular Product with respect to Buyer's application, product or system. Buyer shall take application responsibility in all cases.

NEVER USE THE PRODUCT FOR AN APPLICATION INVOLVING SERIOUS RISK TO LIFE OR PROPERTY OR IN LARGE QUANTITIES WITHOUT ENSURING THAT THE SYSTEM AS A WHOLE HAS BEEN DESIGNED TO ADDRESS THE RISKS, AND THAT THE OMRON PRODUCT(S) IS PROPERLY RATED AND INSTALLED FOR THE INTENDED USE WITHIN THE OVERALL EQUIPMENT OR SYSTEM.

Programmable Products.

Omron Companies shall not be responsible for the user's programming of a programmable Product, or any consequence thereof.

Performance Data.

Data presented in Omron Company websites, catalogs and other materials is provided as a guide for the user in determining suitability and does not constitute a warranty. It may represent the result of Omron's test conditions, and the user must correlate it to actual application requirements. Actual performance is subject to the Omron's Warranty and Limitations of Liability.

Change in Specifications.

Product specifications and accessories may be changed at any time based on improvements and other reasons. It is our practice to change part numbers when published ratings or features are changed, or when significant construction changes are made. However, some specifications of the Product may be changed without any notice. When in doubt, special part numbers may be assigned to fix or establish key specifications for your application. Please consult with your Omron's representative at any time to confirm actual specifications of purchased Product.

Errors and Omissions.

Information presented by Omron Companies has been checked and is believed to be accurate; however, no responsibility is assumed for clerical, typographical or proofreading errors or omissions.

Note: Do not use this document to operate the Unit.

OMRON Corporation Industrial Automation Company

Kyoto, JAPAN

Contact : www.ia.omron.com

Regional Headquarters

OMRON EUROPE B.V.

Wegalaan 67-69, 2132 JD Hoofddorp
The Netherlands
Tel: (31) 2356-81-300 Fax: (31) 2356-81-388

OMRON ELECTRONICS LLC

2895 Greenspoint Parkway, Suite 200
Hoffman Estates, IL 60169 U.S.A.
Tel: (1) 847-843-7900 Fax: (1) 847-843-7787

OMRON ASIA PACIFIC PTE. LTD.

438B Alexandra Road, #08-01/02 Alexandra
Technopark, Singapore 119968
Tel: (65) 6835-3011 Fax: (65) 6835-3011

OMRON (CHINA) CO., LTD.

Room 2211, Bank of China Tower,
200 Yin Cheng Zhong Road,
PuDong New Area, Shanghai, 200120, China
Tel: (86) 21-6023-0333 Fax: (86) 21-5037-2388

Authorized Distributor:

©OMRON Corporation 2018-2025 All Rights Reserved.
In the interest of product improvement,
specifications are subject to change without notice.

CSM_6_13

Cat. No. P140-E1-26 0825 (1218)