

# XW2Z-L

**Connect I/O Terminal Blocks (XW2□) to I/O Units of Programmable Controllers. Fast and Faultless.**



## Ratings and Specifications

<b>Rated current</b>	1 A
<b>Rated voltage</b>	125 VAC 30 VDC
<b>Contact resistance</b>	20 mΩ max. (at 20 mV, 100 mA max.) *1
<b>Insulation resistance</b>	100 MΩ min. (at 500 VDC)
<b>Dielectric strength</b>	500 VAC for 1 min (leakage current: 1 mA max.) *2
<b>Ambient operating temperature</b>	-20 to +75°C (with no condensation or icing) *3

Note: This cable is for fixed parts. Do not use it for moving parts.

\*1. Contact resistance for the Connector.

\*2. Dielectric strength for the Connector.

\*3. However, when bending the cable to perform wiring, maintenance, and other work, do so within the temperature range of 0 to 75°C in consideration of severing of the cable.

## Ordering Information

### XW2Z-□□□□AD-L

FCN 24-pin - MIL 20-pin, Straight Wiring

Appearance	Models	Cable length L (m)		Sheath outer diameter (mm)/ Minimum bending radius (mm)
		L1	L2	
	XW2Z-0050AD-L	0.5		6.7 dia./R54
	XW2Z-0100AD-L	1		
	XW2Z-0200AD-L	2		
	XW2Z-0300AD-L	3		

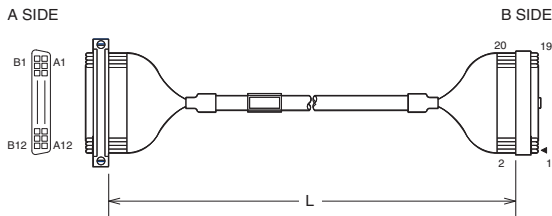

### Wiring Diagram

Connector No.	Wire pair No.	Color of insulator	Color of dot	Connector No.
A S I D E	A1	White	—	B S I D E
	B1	White	Black	
	A2	Black	—	
	B2	Black	White	
	A3	Yellow	—	
	B3	Yellow	Gray	
	A4	Red	—	
	B4	Red	White	
	A5	Purple	—	
	B5	Purple	White	
	A6	Pink	—	
	B6	Pink	White	
	A7	Orange	—	
	B7	Orange	White	
	A8	Brown	—	
	B8	Brown	White	
	A9	Green	—	
	B9	Green	White	
	A10	Light Green	—	
	B10	Light Green	White	
	A11	NC	—	
	B11	NC	—	
	A12	NC	—	
	B12	NC	—	

### XW2Z-□□□□BH-L01

FCN 40-pin - MIL 20-pin, MIL 20-pin

Appearance	Models	Cable length L (m)		Sheath outer diameter (mm)/ Minimum bending radius (mm)
		L1	L2	
	XW2Z-0100BH-L01	1	0.75	8.2 dia./R66
	XW2Z-0150BH-L01	1.5	1.25	
	XW2Z-0200BH-L01	2	1.75	
	XW2Z-0300BH-L01	3	2.75	
	XW2Z-0400BH-L01	4	3.75	
	XW2Z-0500BH-L01	5	4.75	

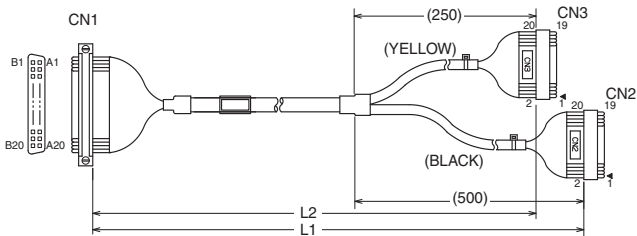

### Wiring Diagram

CN 1 : Fujitsu FCN-367J040-AU/FW

Color of insulator	Color of dot	Connector No.
White	Black	B1
Black	White	B2
Yellow	Gray	B3
Red	White	B4
Purple	White	B5
Pink	White	B6
Orange	White	B7
Brown	White	B8
Green	White	B9
Light Green	White	B10
Gray	White	B11
Blue	White	B12
Light Blue	White	B13
White	Red	B14
Black	Orange	B15
Yellow	Red	B16
Red	Yellow	B17
Purple	Yellow	B18
NC		B19
NC		B20

CN 3 : XG4M-2030-T

Connector No.	Color of insulator	Color of dot
▶ 1	White	Black
2	Light Green	White
3	Black	White
4	Gray	White
5	Yellow	Gray
6	Blue	White
7	Red	White
8	Light Blue	White
9	Purple	White
10	White	Red
11	Pink	White
12	Black	Orange
13	Orange	White
14	Yellow	Red
15	Brown	White
16	Red	Yellow
17	Green	White
18	Purple	Yellow
19	NC	
20	NC	

CN 2 : XG4M-2030-T

Color of insulator	Color of dot	Connector No.
White	—	A1
Black	—	A2
Yellow	—	A3
Red	—	A4
Purple	—	A5
Pink	—	A6
Orange	—	A7
Brown	—	A8
Green	—	A9
Light Green	—	A10
Gray	—	A11
Blue	—	A12
Light Blue	—	A13
White	Yellow	A14
Black	Yellow	A15
Yellow	Black	A16
Red	Black	A17
Purple	Black	A18
NC		A19
NC		A20

Connector No.	Color of insulator	Color of dot
▶ 1	White	—
2	Light Green	—
3	Black	—
4	Gray	—
5	Yellow	—
6	Blue	—
7	Red	—
8	Light Blue	—
9	Purple	—
10	White	Yellow
11	Pink	—
12	Black	Yellow
13	Orange	—
14	Yellow	Black
15	Brown	—
16	Red	Black
17	Green	—
18	Purple	Black
19	NC	
20	NC	

## XW2Z-□□□□BH-L02

FCN 40-pin - MIL 20-pin, MIL 20-pin

Appearance	Models	Cable length L (m)		Sheath outer diameter (mm)/ Minimum bending radius (mm)
		L1	L2	
	XW2Z-0100BH-L02	1	0.75	8.2 dia/R66
	XW2Z-0150BH-L02	1.5	1.25	
	XW2Z-0200BH-L02	2	1.75	
	XW2Z-0300BH-L02	3	2.75	
	XW2Z-0400BH-L02	4	3.75	
	XW2Z-0500BH-L02	5	4.75	

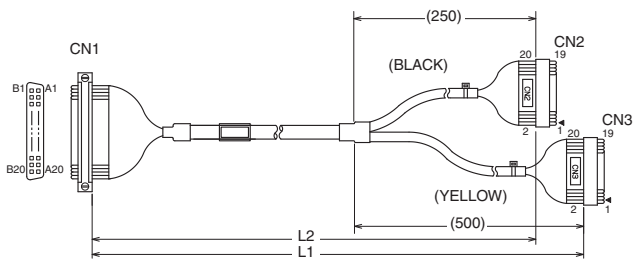

### Wiring Diagram

CN 1 : Fujitsu FCN-367J040-AU/FW

Color of insulator	Color of dot	Connector No.
White	Black	B1
Black	White	B2
Yellow	Gray	B3
Red	White	B4
Purple	White	B5
Pink	White	B6
Orange	White	B7
Brown	White	B8
Green	White	B9
Light Green	White	B10
Gray	White	B11
Blue	White	B12
Light Blue	White	B13
White	Red	B14
Black	Orange	B15
Yellow	Red	B16
Red	Yellow	B17
Purple	Yellow	B18
Pink	Yellow	B19
Orange	Yellow	B20

CN 3 : XG4M-2030-T

Connector No.	Color of insulator	Color of dot
20	White	Black
19	Gray	White
18	Black	White
17	Blue	White
16	Yellow	Gray
15	Light Blue	White
14	Red	White
13	White	Red
12	Purple	White
11	Black	Orange
10	Pink	White
9	Yellow	Red
8	Orange	White
7	Red	Yellow
6	Brown	White
5	Purple	Yellow
4	Green	White
3	Pink	Yellow
2	Light Green	White
▶ 1	Orange	Yellow

Color of insulator	Color of dot	Connector No.
White	-	A1
Black	-	A2
Yellow	-	A3
Red	-	A4
Purple	-	A5
Pink	-	A6
Orange	-	A7
Brown	-	A8
Green	-	A9
Light Green	-	A10
Gray	-	A11
Blue	-	A12
Light Blue	-	A13
White	Yellow	A14
Black	Yellow	A15
Yellow	Black	A16
Red	Black	A17
Purple	Black	A18
Pink	Black	A19
Orange	Black	A20

CN 2 : XG4M-2030-T

Connector No.	Color of insulator	Color of dot
20	White	-
19	Gray	-
18	Black	-
17	Blue	-
16	Yellow	-
15	Light Blue	-
14	Red	-
13	White	Yellow
12	Purple	-
11	Black	Yellow
10	Pink	-
9	Yellow	Black
8	Orange	-
7	Red	Black
6	Brown	-
5	Purple	Black
4	Green	-
3	Pink	Black
2	Light Green	-
▶ 1	Orange	Black

## XW2Z-□□□□BF-L

FCN 40-pin - MIL 40-pin, Straight Wiring

Appearance	Models	Cable length L (m)	Sheath outer diameter (mm)/ Minimum bending radius (mm)
	XW2Z-0050BF-L	0.5	8.2 dia/R66
	XW2Z-0100BF-L	1	
	XW2Z-0150BF-L	1.5	
	XW2Z-0200BF-L	2	
	XW2Z-0300BF-L	3	
	XW2Z-0500BF-L	5	
	XW2Z-0700BF-L	7	
	XW2Z-1000BF-L	10	

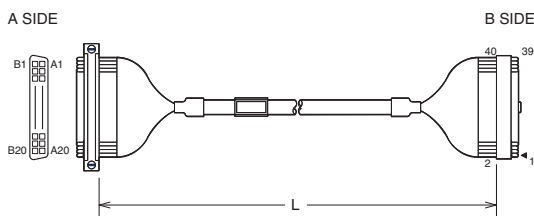

### Wiring Diagram

Connector No.	Wire pair No.	Color of insulator	Color of dot	Connector No.
A1	1	White	-	▶ 1
B1		White	Black	2
A2	2	Black	-	3
B2		Black	White	4
A3	3	Yellow	-	5
B3		Yellow	Gray	6
A4	4	Red	-	7
B4		Red	White	8
A5	5	Purple	-	9
B5		Purple	White	10
A6	6	Pink	-	11
B6		Pink	White	12
A7	7	Orange	-	13
B7		Orange	White	14
A8	8	Brown	-	15
B8		Brown	White	16
A9	9	Green	-	17
B9		Green	White	18
A10	10	Light Green	-	19
B10		Light Green	White	20
A11	11	Gray	-	21
B11		Gray	White	22
A12	12	Blue	-	23
B12		Blue	White	24
A13	13	Light Blue	-	25
B13		Light Blue	White	26
A14	14	White	Yellow	27
B14		White	Red	28
A15	15	Black	Yellow	29
B15		Black	Orange	30
A16	16	Yellow	Black	31
B16		Yellow	Red	32
A17	17	Red	Black	33
B17		Red	Yellow	34
A18	18	Purple	Black	35
B18		Purple	Yellow	36
A19	19	Pink	Black	37
B19		Pink	Yellow	38
A20	20	Orange	Black	39
B20		Orange	Yellow	40

XW2Z-□□□□CJ-L01

FCN 56-pin - MIL 20-pin, MIL 20-pin, MIL 20-pin

Appearance	Models	Cable length L (m)		Sheath outer diameter (mm)/ Minimum bending radius (mm)
		L1	L2	
	XW2Z-0150CJ-L01	1.5	1.25	10.0 dia/R80
	XW2Z-0200CJ-L01	2	1.75	
	XW2Z-0300CJ-L01	3	2.75	

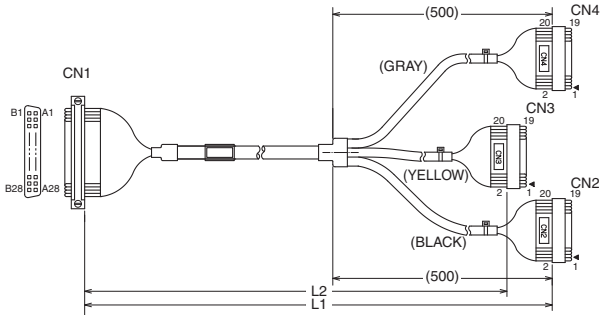

Wiring Diagram

CN 1 : Fujitsu FCN-367J056-AU/FW

Color of insulator	Color of dot	Connector No.
White	Black	B1
Black	White	B2
Yellow	Gray	B3
Red	White	B4
Purple	White	B5
Pink	White	B6
Orange	White	B7
Brown	White	B8
Green	White	B9
Light Green	White	B10
Gray	White	B11
Blue	White	B12
Light Blue	White	B13
White	Red	B14
Black	Orange	B15
Yellow	Red	B16
Red	Yellow	B17
Purple	Yellow	B18
Pink	Yellow	B19
Orange	Yellow	B20
Brown	Yellow	B21
Green	Orange	B22
Light Green	Yellow	B23
Gray	Yellow	B24
Blue	Yellow	B25
Light Blue	Yellow	B26
White	Pink	B27
NC		B28

Color of insulator	Color of dot	Connector No.
White	-	A1
Black	-	A2
Yellow	-	A3
Red	-	A4
Purple	-	A5
Pink	-	A6
Orange	-	A7
Brown	-	A8
Green	-	A9
Light Green	-	A10
Gray	-	A11
Blue	-	A12
Light Blue	-	A13
White	Yellow	A14
Black	Yellow	A15
Yellow	Black	A16
Red	Black	A17
Purple	Black	A18
Pink	Black	A19
Orange	Black	A20
Brown	Black	A21
Green	Black	A22
Light Green	Black	A23
Gray	Black	A24
Blue	Black	A25
Light Blue	Black	A26
White	Purple	A27
NC		A28

CN4 : XG4M-2030-T

Connector No.	Color of insulator	Color of dot
▶ 1	Pink	Black
2	Pink	Yellow
3	Orange	Black
4	Orange	Yellow
5	Brown	Black
6	Brown	Yellow
7	Green	Black
8	Green	Orange
9	Light Green	Black
10	Light Green	Yellow
11	Gray	Black
12	Gray	Yellow
13	Blue	Black
14	Blue	Yellow
15	Light Blue	Black
16	Light Blue	Yellow
17	White	Purple
18	White	Pink
19		NC
20		NC

CN 3 : XG4M-2030-T

Connector No.	Color of insulator	Color of dot
▶ 1	Light Green	-
2	Light Green	White
3	Gray	-
4	Gray	White
5	Blue	-
6	Blue	White
7	Light Blue	-
8	Light Blue	White
9	White	Yellow
10	White	Red
11	Black	Yellow
12	Black	Orange
13	Yellow	Black
14	Yellow	Red
15	Red	Black
16	Red	Yellow
17	Purple	Black
18	Purple	Yellow
19		NC
20		NC

CN 2 : XG4M-2030-T

Connector No.	Color of insulator	Color of dot
▶ 1	White	-
2	White	Black
3	Black	-
4	Black	White
5	Yellow	-
6	Yellow	Gray
7	Red	-
8	Red	White
9	Purple	-
10	Purple	White
11	Pink	-
12	Pink	White
13	Orange	-
14	Orange	White
15	Brown	-
16	Brown	White
17	Green	-
18	Green	White
19		NC
20		NC

## XW2Z-□□□□CJ-L02

FCN 56-pin - MIL 20-pin, MIL 20-pin, MIL 20-pin

Appearance	Models	Cable length L (m)			Sheath outer diameter (mm)/ Minimum bending radius (mm)
		L1	L2	L3	
	XW2Z-0150CJ-L02	1.5	1.25	1	10.0 dia/R80
	XW2Z-0200CJ-L02	2	1.75	1.5	
	XW2Z-0300CJ-L02	3	2.75	2.5	

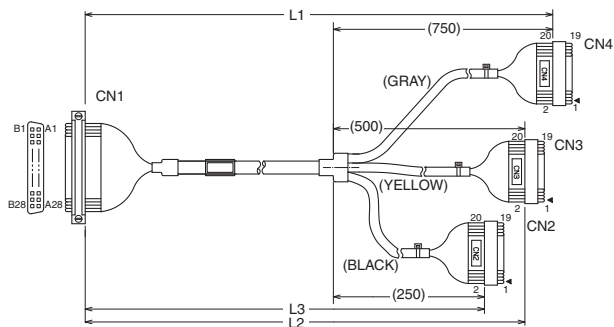

### Wiring Diagram

CN 1 : Fujitsu FCN-367J056-AU/FW

Color of insulator	Color of dot	Connector No.
White	Black	B1
Black	White	B2
Yellow	Gray	B3
Red	White	B4
Purple	White	B5
Pink	White	B6
Orange	White	B7
Brown	White	B8
Green	White	B9
Light Green	White	B10
Gray	White	B11
Blue	White	B12
Light Blue	White	B13
White	Red	B14
Black	Orange	B15
Yellow	Red	B16
Red	Yellow	B17
Purple	Yellow	B18
Pink	Yellow	B19
Orange	Yellow	B20
Brown	Yellow	B21
Green	Orange	B22
Light Green	Yellow	B23
Gray	Yellow	B24
Blue	Yellow	B25
Light Blue	Yellow	B26
White	Pink	B27
NC		B28

Color of insulator	Color of dot	Connector No.
White	-	A1
Black	-	A2
Yellow	-	A3
Red	-	A4
Purple	-	A5
Pink	-	A6
Orange	-	A7
Brown	-	A8
Green	-	A9
Light Green	-	A10
Gray	-	A11
Blue	-	A12
Light Blue	-	A13
White	Yellow	A14
Black	Yellow	A15
Yellow	Black	A16
Red	Black	A17
Purple	Black	A18
Pink	Black	A19
Orange	Black	A20
Brown	Black	A21
Green	Black	A22
Light Green	Black	A23
Gray	Black	A24
Blue	Black	A25
Light Blue	Black	A26
White	Purple	A27
NC		A28

CN4 : XG4M-2030-T

Connector No.	Color of insulator	Color of dot
20	Pink	Black
19	Pink	Yellow
18	Orange	Black
17	Orange	Yellow
16	Brown	Black
15	Brown	Yellow
14	Green	Black
13	Green	Orange
12	Light Green	Black
11	Light Green	Yellow
10	Gray	Black
9	Gray	Yellow
8	Blue	Black
7	Blue	Yellow
6	Light Blue	Black
5	Light Blue	Yellow
4	White	Purple
3		NC
2		NC
▶ 1	White	Pink

CN 3 : XG4M-2030-T

Connector No.	Color of insulator	Color of dot
20	Light Green	-
19	Light Green	White
18	Gray	-
17	Gray	White
16	Blue	White
15	Blue	White
14	Light Blue	-
13	Light Blue	White
12	White	Yellow
11	White	Red
10	Black	Yellow
9	Black	Orange
8	Yellow	Black
7	Yellow	Red
6	Red	Black
5	Red	Yellow
4	Purple	Black
3		NC
2		NC
▶ 1	Purple	Yellow

CN 2 : XG4M-2030-T

Connector No.	Color of insulator	Color of dot
20	White	-
19	White	Black
18	Black	-
17	Black	White
16	Yellow	-
15	Yellow	Gray
14	Red	-
13	Red	White
12	Purple	-
11	Purple	White
10	Pink	-
9	Pink	White
8	Orange	-
7	Orange	White
6	Brown	-
5	Brown	White
4	Green	-
3		NC
2		NC
▶ 1	Green	White

XW2Z-□□□□CK-L0□

FCN 56-pin - MIL 40-pin, MIL 20-pin

Appearance	Models	Cable length L (m)		Sheath outer diameter (mm)/ Minimum bending radius (mm)
		L1	L2	
	XW2Z-0150CK-L01	1.5	1.25	10.0 dia/R80
	XW2Z-0150CK-L02	1.5	1.25	
	XW2Z-0200CK-L01	2	1.75	
	XW2Z-0200CK-L02	2	1.75	

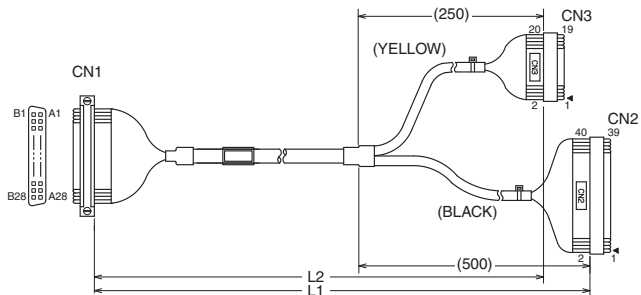

Wiring Diagram

XW2Z-0150CK-L01, XW2Z-0200CK-L01

CN 1 : Fujitsu FCN-367J056-AU/FW

Color of insulator	Color of dot	Connector No.
White	Black	B1
Black	White	B2
Yellow	Gray	B3
Red	White	B4
Purple	White	B5
Pink	White	B6
Orange	White	B7
Brown	White	B8
Green	White	B9
Light Green	White	B10
Gray	White	B11
Blue	White	B12
Light Blue	White	B13
White	Red	B14
Black	Orange	B15
Yellow	Red	B16
Red	Yellow	B17
Purple	Yellow	B18
Pink	Yellow	B19
Orange	Yellow	B20
Brown	Yellow	B21
Green	Orange	B22
Light Green	Yellow	B23
Gray	Yellow	B24
Blue	Yellow	B25
Light Blue	Yellow	B26
White	Pink	B27
NC		B28

CN3 : XG4M-2030-T

Connector No.	Color of insulator	Color of dot
▶ 1	Pink	Black
2	Pink	Yellow
3	Orange	Black
4	Orange	Yellow
5	Brown	Black
6	Brown	Yellow
7	Green	Black
8	Green	Orange
9	Light Green	Black
10	Light Green	Yellow
11	Gray	Black
12	Gray	Yellow
13	Blue	Black
14	Blue	Yellow
15	Light Blue	Black
16	Light Blue	Yellow
17	White	Purple
18	White	Pink
19		NC
20		NC

CN2 : XG4M-4030-T

Connector No.	Color of insulator	Color of dot
▶ 1	White	-
2	White	Black
3	Black	-
4	Black	White
5	Yellow	-
6	Yellow	Gray
7	Red	-
8	Red	White
9	Purple	-
10	Purple	White
11	Pink	-
12	Pink	White
13	Orange	-
14	Orange	White
15	Brown	-
16	Brown	White
17	Green	-
18	Green	White
19		NC
20		NC
21	Light Green	-
22	Light Green	White
23	Gray	-
24	Gray	White
25	Blue	-
26	Blue	White
27	Light Blue	-
28	Light Blue	White
29	White	Yellow
30	White	Red
31	Black	Yellow
32	Black	Orange
33	Yellow	Black
34	Yellow	Red
35	Red	Black
36	Red	Yellow
37	Purple	Black
38	Purple	Yellow
39		NC
40		NC

Color of insulator	Color of dot	Connector No.
White	-	A1
Black	-	A2
Yellow	-	A3
Red	-	A4
Purple	-	A5
Pink	-	A6
Orange	-	A7
Brown	-	A8
Green	-	A9
Light Green	-	A10
Gray	-	A11
Blue	-	A12
Light Blue	-	A13
White	Yellow	A14
Black	Yellow	A15
Yellow	Black	A16
Red	Black	A17
Purple	Black	A18
Pink	Black	A19
Orange	Black	A20
Brown	Black	A21
Green	Black	A22
Light Green	Black	A23
Gray	Black	A24
Blue	Black	A25
Light Blue	Black	A26
White	Purple	A27
NC		A28

Wiring Diagram

XW2Z-0150CK-L02, XW2Z-0200CK-L02

CN 1 : Fujitsu FCN-367J056-AU/FW

Color of insulator	Color of dot	Connector No.
White	Black	B1
Black	White	B2
Yellow	Gray	B3
Red	White	B4
Purple	White	B5
Pink	White	B6
Orange	White	B7
Brown	White	B8
Green	White	B9
Light Green	White	B10
Gray	White	B11
Blue	White	B12
Light Blue	White	B13
White	Red	B14
Black	Orange	B15
Yellow	Red	B16
Red	Yellow	B17
Purple	Yellow	B18
Pink	Yellow	B19
Orange	Yellow	B20
Brown	Yellow	B21
Green	Orange	B22
Light Green	Yellow	B23
Gray	Yellow	B24
Blue	Yellow	B25
Light Blue	Yellow	B26
White	Pink	B27
NC		B28

CN3 : XG4M-2030-T

Connector No.	Color of insulator	Color of dot
▶ 1	White	Pink
2		NC
3		NC
4	White	Purple
5	Light Blue	Yellow
6	Light Blue	Black
7	Blue	Yellow
8	Blue	Black
9	Gray	Yellow
10	Gray	Black
11	Light Green	Yellow
12	Light Green	Black
13	Green	Orange
14	Green	Black
15	Brown	Yellow
16	Brown	Black
17	Orange	Yellow
18	Orange	Black
19	Pink	Yellow
20	Pink	Black

CN2 : XG4M-4030-T

Connector No.	Color of insulator	Color of dot
▶ 1	Green	White
2		NC
3		NC
4	Green	-
5	Brown	White
6	Brown	-
7	Orange	White
8	Orange	-
9	Pink	White
10	Pink	-
11	Purple	White
12	Purple	-
13	Red	White
14	Red	-
15	Yellow	Gray
16	Yellow	-
17	Black	White
18	Black	-
19	White	Black
20	White	-
21	Purple	Yellow
22		NC
23		NC
24	Purple	Black
25	Red	Yellow
26	Red	Black
27	Yellow	Red
28	Yellow	Black
29	Black	Orange
30	Black	Yellow
31	White	Red
32	White	Yellow
33	Light Blue	White
34	Light Blue	-
35	Blue	White
36	Blue	-
37	Gray	White
38	Gray	-
39	Light Green	White
40	Light Green	-

Color of insulator	Color of dot	Connector No.
White	-	A1
Black	-	A2
Yellow	-	A3
Red	-	A4
Purple	-	A5
Pink	-	A6
Orange	-	A7
Brown	-	A8
Green	-	A9
Light Green	-	A10
Gray	-	A11
Blue	-	A12
Light Blue	-	A13
White	Yellow	A14
Black	Yellow	A15
Yellow	Black	A16
Red	Black	A17
Purple	Black	A18
Pink	Black	A19
Orange	Black	A20
Brown	Black	A21
Green	Black	A22
Light Green	Black	A23
Gray	Black	A24
Blue	Black	A25
Light Blue	Black	A26
White	Purple	A27
NC		A28

XW2Z-□□□□CG-L

FCN 56-pin - MIL 60-pin, Straight Wiring

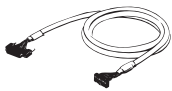
Appearance	Models	Cable length L (m)	Sheath outer diameter (mm)/ Minimum bending radius (mm)
	XW2Z-0100CG-L	1	10.0 dia/R80
	XW2Z-0200CG-L	2	
	XW2Z-0300CG-L	3	

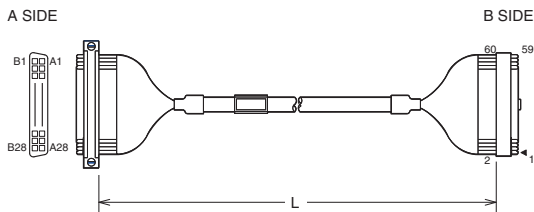

Wiring Diagram

Connector No.	Cable core No.	Color of insulator	Color of dot	Connector No.
A1	1	White	—	▶ 1
B1		White	Black	2
A2	2	Black	—	3
B2		Black	White	4
A3	3	Yellow	—	5
B3		Yellow	Gray	6
A4	4	Red	—	7
B4		Red	White	8
A5	5	Purple	—	9
B5		Purple	White	10
A6	6	Pink	—	11
B6		Pink	White	12
A7	7	Orange	—	13
B7		Orange	White	14
A8	8	Brown	—	15
B8		Brown	White	16
A9	9	Green	—	17
B9		Green	White	18
A10	10	Light Green	—	19
B10		Light Green	White	20
A11	11	Gray	—	21
B11		Gray	White	22
A12	12	Blue	—	23
B12		Blue	White	24
A13	13	Light Blue	—	25
B13		Light Blue	White	26
A14	14	White	Yellow	27
B14		White	Red	28
A15	15	Black	Yellow	29
B15		Black	Orange	30
A16	16	Yellow	Black	31
B16		Yellow	Red	32
A17	17	Red	Black	33
B17		Red	Yellow	34
A18	18	Purple	Black	35
B18		Purple	Yellow	36
A19	19	Pink	Black	37
B19		Pink	Yellow	38
A20	20	Orange	Black	39
B20		Orange	Yellow	40
A21	21	Brown	Black	41
B21		Brown	Yellow	42
A22	22	Green	Black	43
B22		Green	Orange	44
A23	23	Light Green	Black	45
B23		Light Green	Yellow	46
A24	24	Gray	Black	47
B24		Gray	Yellow	48
A25	25	Blue	Black	49
B25		Blue	Yellow	50
A26	26	Light Blue	Black	51
B26		Light Blue	Yellow	52
A27	27	White	Purple	53
B27		White	Pink	54
A28	28	NC	—	55
B28		NC	—	56
—	29	NC	—	57
—		NC	—	58
—	30	NC	—	59
—		NC	—	60

XW2Z-□□□□DD-L

MIL 20-pin - MIL 20-pin, Straight Wiring

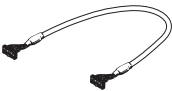
Appearance	Models	Cable length L (m)	Sheath outer diameter (mm)/ Minimum bending radius (mm)
	XW2Z-0050DD-L	0.5	6.7 dia/R54
	XW2Z-0100DD-L	1	
	XW2Z-0200DD-L	2	

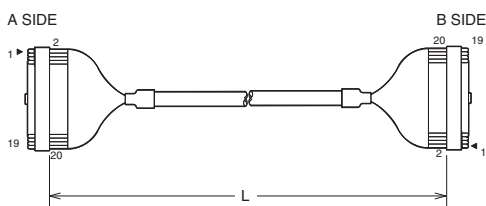

Wiring Diagram

Connector No.	Wire pair No.	Color of insulator	Color of dot	Connector No.
▶ 1	1	White	—	▶ 1
2		White	Black	2
3	2	Black	—	3
4		Black	White	4
5	3	Yellow	—	5
6		Yellow	Gray	6
7	4	Red	—	7
8		Red	White	8
9	5	Purple	—	9
10		Purple	White	10
11	6	Pink	—	11
12		Pink	White	12
13	7	Orange	—	13
14		Orange	White	14
15	8	Brown	—	15
16		Brown	White	16
17	9	Green	—	17
18		Green	White	18
19	10	Light Green	—	19
20		Light Green	White	20



XW2Z-□□□□EE-L

MIL 34-pin - MIL 34-pin, Straight Wiring

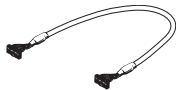
Appearance	Model	Cable length L (m)	Sheath outer diameter (mm)/ Minimum bending radius (mm)
	XW2Z-0050EE-L	0.5	8.2 dia/R66
	XW2Z-0100EE-L	1	
	XW2Z-0150EE-L	1.5	
	XW2Z-0200EE-L	2	
	XW2Z-0300EE-L	3	
	XW2Z-0500EE-L	5	
	XW2Z-1000EE-L	10	

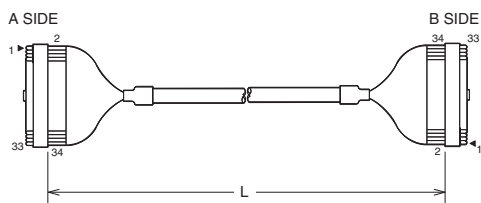

Wiring Diagram

Connector No.	Wire pair No.	Color of insulator	Color of dot	Connector No.
▶ 1	1	White	—	▶ 1
2		White	Black	2
3	2	Black	—	3
4		Black	White	4
5	3	Yellow	—	5
6		Yellow	Gray	6
7	4	Red	—	7
8		Red	White	8
9	5	Purple	—	9
10		Purple	White	10
11	6	Pink	—	11
12		Pink	White	12
13	7	Orange	—	13
14		Orange	White	14
15	8	Brown	—	15
16		Brown	White	16
17	9	Green	—	17
18		Green	White	18
19	10	Light Green	—	19
20		Light Green	White	20
21	11	Gray	—	21
22		Gray	White	22
23	12	Blue	—	23
14		Blue	White	24
25	13	Light Blue	—	25
26		Light Blue	White	26
27	14	White	Yellow	27
28		White	Red	28
29	15	Black	Yellow	29
30		Black	Orange	30
31	16	Yellow	Black	31
32		Yellow	Red	32
33	17	Red	Black	33
34		Red	Yellow	34

XW2Z-□□□□FH-L01

FCN 40-pin - MIL 20-pin, MIL 20-pin

Appearance	Models	Cable length L (m)		Sheath outer diameter (mm)/ Minimum bending radius (mm)
		L1	L2	
	XW2Z-0075FH-L01	0.75	0.5	8.2 dia/R66
	XW2Z-0100FH-L01	1	0.75	
	XW2Z-0200FH-L01	2	1.75	
	XW2Z-0300FH-L01	3	2.75	
	XW2Z-0500FH-L01	5	4.75	

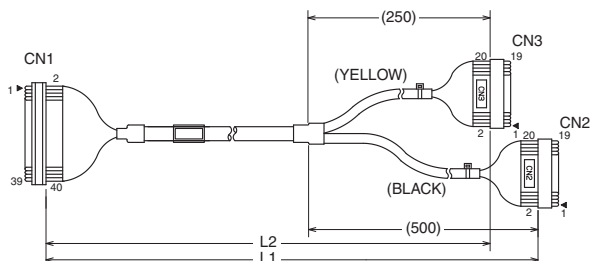

Wiring Diagram

CN 1 : XG4M-4030-T

Color of insulator	Color of dot	Connector No.
Orange	Yellow	40
Orange	Black	39
Pink	Yellow	38
Pink	Black	37
Purple	Yellow	36
Purple	Black	35
Red	Yellow	34
Red	Black	33
Yellow	Red	32
Yellow	Black	31
Black	Orange	30
Black	Yellow	29
White	Red	28
White	Yellow	27
Light Blue	White	26
Light Blue	—	25
Blue	White	24
Blue	—	23
Gray	White	22
Gray	—	21

CN2 : XG4M-2030-T

Connector No.	Color of insulator	Color of dot
▶ 1	Orange	Yellow
2	Orange	Black
3	Pink	Yellow
4	Pink	Black
5	Purple	Yellow
6	Purple	Black
7	Red	Yellow
8	Red	Black
9	Yellow	Red
10	Yellow	Black
11	Black	Orange
12	Black	Yellow
13	White	Red
14	White	Yellow
15	Light Blue	White
16	Light Blue	—
17	Blue	White
18	Blue	—
19	Gray	White
20	Gray	—

CN 3 : XG4M-2030-T

Color of insulator	Color of dot	Connector No.	Connector No.	Color of insulator	Color of dot
Light Green	White	20	▶ 1	Light Green	White
Light Green	—	19	2	Light Green	—
Green	White	18	3	Green	White
Green	—	17	4	Green	—
Brown	White	16	5	Brown	White
Brown	—	15	6	Brown	—
Orange	White	14	7	Orange	White
Orange	—	13	8	Orange	—
Pink	White	12	9	Pink	White
Pink	—	11	10	Pink	—
Purple	White	10	11	Purple	White
Purple	—	9	12	Purple	—
Red	White	8	13	Red	White
Red	—	7	14	Red	—
Yellow	Gray	6	15	Yellow	Gray
Yellow	—	5	16	Yellow	—
Black	White	4	17	Black	White
Black	—	3	18	Black	—
White	Black	2	19	White	Black
White	—	▶ 1	20	White	—



## XW2Z-□□□□FH-L02

FCN 40-pin - MIL 20-pin, MIL 20-pin

Appearance	Models	Cable length L (m)		Sheath outer diameter (mm)/ Minimum bending radius (mm)
		L1	L2	
	XW2Z-0075FH-L02	0.75	0.5	8.2 dia/R66
	XW2Z-0100FH-L02	1	0.75	
	XW2Z-0200FH-L02	2	1.75	
	XW2Z-0300FH-L02	3	2.75	
	XW2Z-0500FH-L02	5	4.75	

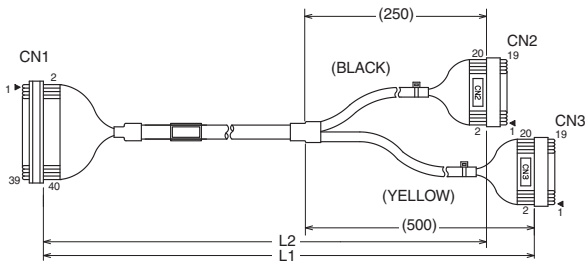

### Wiring Diagram

CN 1 : XG4M-4030-T

Color of insulator	Color of dot	Connector No.
Orange	Yellow	40
Orange	Black	39
Pink	Yellow	38
Pink	Black	37
Purple	Yellow	36
Purple	Black	35
Red	Yellow	34
Red	Black	33
Yellow	Red	32
Yellow	Black	31
Black	Orange	30
Black	Yellow	29
White	Red	28
White	Yellow	27
Light Blue	White	26
Light Blue	-	25
Blue	White	24
Blue	-	23
Gray	White	22
Gray	-	21

CN2 : XG4M-2030-T

Connector No.	Color of insulator	Color of dot
20	Orange	Yellow
19	Orange	Black
18	Pink	Yellow
17	Pink	Black
16	Purple	Yellow
15	Purple	Black
14	Red	Yellow
13	Red	Black
12	Yellow	Red
11	Yellow	Black
10	Black	Orange
9	Black	Yellow
8	White	Red
7	White	Yellow
6	Light Blue	White
5	Light Blue	-
4	Blue	White
3	Blue	-
2	Gray	White
▶ 1	Gray	-

CN 3 : XG4M-2030-T

Color of insulator	Color of dot	Connector No.
Light Green	White	20
Light Green	-	19
Green	White	18
Green	-	17
Brown	White	16
Brown	-	15
Orange	White	14
Orange	-	13
Pink	White	12
Pink	-	11
Purple	White	10
Purple	-	9
Red	White	8
Red	-	7
Yellow	Gray	6
Yellow	-	5
Black	White	4
Black	-	3
White	Black	2
White	-	▶ 1

Connector No.	Color of insulator	Color of dot
20	Light Green	White
19	Light Green	-
18	Green	White
17	Green	-
16	Brown	White
15	Brown	-
14	Orange	White
13	Orange	-
12	Pink	White
11	Pink	-
10	Purple	White
9	Purple	-
8	Red	White
7	Red	-
6	Yellow	Gray
5	Yellow	-
4	Black	White
3	Black	-
2	White	Black
▶ 1	White	-

## XW2Z-□□□□FF-L

MIL 40-pin - MIL 40-pin, Straight Wiring

Appearance	Models	Cable length L (m)	Sheath outer diameter (mm)/ Minimum bending radius (mm)
	XW2Z-0030FF-L	0.3	8.2 dia/R66
	XW2Z-0050FF-L	0.5	
	XW2Z-0100FF-L	1	
	XW2Z-0150FF-L	1.5	
	XW2Z-0200FF-L	2	
	XW2Z-0300FF-L	3	
	XW2Z-0500FF-L	5	
	XW2Z-1000FF-L	10	

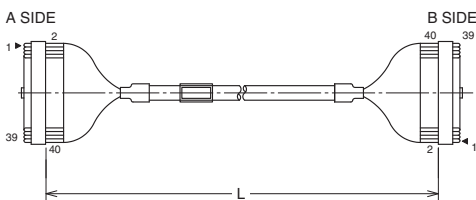

### Wiring Diagram

Connector No.	Wire pair No.	Color of insulator	Color of dot	Connector No.
▶ 1		White	-	▶ 1
2	1	White	Black	2
3		Black	-	3
4	2	Black	White	4
5		Yellow	-	5
6	3	Yellow	Gray	6
7		Red	-	7
8	4	Red	White	8
9		Purple	-	9
10	5	Purple	White	10
11		Pink	-	11
12	6	Pink	White	12
13		Orange	-	13
14	7	Orange	White	14
15		Brown	-	15
16	8	Brown	White	16
17		Green	-	17
18	9	Green	White	18
19		Light Green	-	19
20	10	Light Green	White	20
21		Gray	-	21
22	11	Gray	White	22
23		Blue	-	23
24	12	Blue	White	24
25		Light Blue	-	25
26	13	Light Blue	White	26
27		White	Yellow	27
28	14	White	Red	28
29		Black	Yellow	29
30	15	Black	Orange	30
31		Yellow	Black	31
32	16	Yellow	Red	32
33		Red	Black	33
34	17	Red	Yellow	34
35		Purple	Black	35
36	18	Purple	Yellow	36
37		Pink	Black	37
38	19	Pink	Yellow	38
39		Orange	Black	39
40	20	Orange	Yellow	40

# Terms and Conditions Agreement

## **Read and understand this catalog.**

Please read and understand this catalog before purchasing the products. Please consult your OMRON representative if you have any questions or comments.

## **Warranties.**

(a) Exclusive Warranty. Omron's exclusive warranty is that the Products will be free from defects in materials and workmanship for a period of twelve months from the date of sale by Omron (or such other period expressed in writing by Omron). Omron disclaims all other warranties, express or implied.

(b) Limitations. OMRON MAKES NO WARRANTY OR REPRESENTATION, EXPRESS OR IMPLIED, ABOUT NON-INFRINGEMENT, MERCHANTABILITY OR FITNESS FOR A PARTICULAR PURPOSE OF THE PRODUCTS. BUYER ACKNOWLEDGES THAT IT ALONE HAS DETERMINED THAT THE PRODUCTS WILL SUITABLY MEET THE REQUIREMENTS OF THEIR INTENDED USE.

Omron further disclaims all warranties and responsibility of any type for claims or expenses based on infringement by the Products or otherwise of any intellectual property right. (c) Buyer Remedy. Omron's sole obligation hereunder shall be, at Omron's election, to (i) replace (in the form originally shipped with Buyer responsible for labor charges for removal or replacement thereof) the non-complying Product, (ii) repair the non-complying Product, or (iii) repay or credit Buyer an amount equal to the purchase price of the non-complying Product; provided that in no event shall Omron be responsible for warranty, repair, indemnity or any other claims or expenses regarding the Products unless Omron's analysis confirms that the Products were properly handled, stored, installed and maintained and not subject to contamination, abuse, misuse or inappropriate modification. Return of any Products by Buyer must be approved in writing by Omron before shipment. Omron Companies shall not be liable for the suitability or unsuitability or the results from the use of Products in combination with any electrical or electronic components, circuits, system assemblies or any other materials or substances or environments. Any advice, recommendations or information given orally or in writing, are not to be construed as an amendment or addition to the above warranty.

See <http://www.omron.com/global/> or contact your Omron representative for published information.

## **Limitation on Liability: Etc.**

OMRON COMPANIES SHALL NOT BE LIABLE FOR SPECIAL, INDIRECT, INCIDENTAL, OR CONSEQUENTIAL DAMAGES, LOSS OF PROFITS OR PRODUCTION OR COMMERCIAL LOSS IN ANY WAY CONNECTED WITH THE PRODUCTS, WHETHER SUCH CLAIM IS BASED IN CONTRACT, WARRANTY, NEGLIGENCE OR STRICT LIABILITY.

Further, in no event shall liability of Omron Companies exceed the individual price of the Product on which liability is asserted.

## **Suitability of Use.**

Omron Companies shall not be responsible for conformity with any standards, codes or regulations which apply to the combination of the Product in the Buyer's application or use of the Product. At Buyer's request, Omron will provide applicable third party certification documents identifying ratings and limitations of use which apply to the Product. This information by itself is not sufficient for a complete determination of the suitability of the Product in combination with the end product, machine, system, or other application or use. Buyer shall be solely responsible for determining appropriateness of the particular Product with respect to Buyer's application, product or system. Buyer shall take application responsibility in all cases.

NEVER USE THE PRODUCT FOR AN APPLICATION INVOLVING SERIOUS RISK TO LIFE OR PROPERTY OR IN LARGE QUANTITIES WITHOUT ENSURING THAT THE SYSTEM AS A WHOLE HAS BEEN DESIGNED TO ADDRESS THE RISKS, AND THAT THE OMRON PRODUCT(S) IS PROPERLY RATED AND INSTALLED FOR THE INTENDED USE WITHIN THE OVERALL EQUIPMENT OR SYSTEM.

## **Programmable Products.**

Omron Companies shall not be responsible for the user's programming of a programmable Product, or any consequence thereof.

## **Performance Data.**

Data presented in Omron Company websites, catalogs and other materials is provided as a guide for the user in determining suitability and does not constitute a warranty. It may represent the result of Omron's test conditions, and the user must correlate it to actual application requirements. Actual performance is subject to the Omron's Warranty and Limitations of Liability.

## **Change in Specifications.**

Product specifications and accessories may be changed at any time based on improvements and other reasons. It is our practice to change part numbers when published ratings or features are changed, or when significant construction changes are made. However, some specifications of the Product may be changed without any notice. When in doubt, special part numbers may be assigned to fix or establish key specifications for your application. Please consult with your Omron's representative at any time to confirm actual specifications of purchased Product.

## **Errors and Omissions.**

Information presented by Omron Companies has been checked and is believed to be accurate; however, no responsibility is assumed for clerical, typographical or proofreading errors or omissions.

**Note: Do not use this document to operate the Unit.**

**OMRON Corporation Industrial Automation Company**

**Kyoto, JAPAN**

**Contact : [www.ia.omron.com](http://www.ia.omron.com)**

**Regional Headquarters**

**OMRON EUROPE B.V.**

Wegalaan 67-69, 2132 JD Hoofddorp  
The Netherlands  
Tel: (31) 2356-81-300 Fax: (31) 2356-81-388

**OMRON ELECTRONICS LLC**

2895 Greenspoint Parkway, Suite 200  
Hoffman Estates, IL 60169 U.S.A.  
Tel: (1) 847-843-7900 Fax: (1) 847-843-7787

**OMRON ASIA PACIFIC PTE. LTD.**

438B Alexandra Road, #08-01/02 Alexandra  
Technopark, Singapore 119968  
Tel: (65) 6835-3011 Fax: (65) 6835-3011

**OMRON (CHINA) CO., LTD.**

Room 2211, Bank of China Tower,  
200 Yin Cheng Zhong Road,  
PuDong New Area, Shanghai, 200120, China  
Tel: (86) 21-6023-0333 Fax: (86) 21-5037-2388

**Authorized Distributor:**

©OMRON Corporation 2009-2023 All Rights Reserved.  
In the interest of product improvement,  
specifications are subject to change without notice.

**CSM\_2\_3**

**Cat. No. G083-E1-04 0723 (1013)**