

R61S SMART

Code (white)	Nominal/lm	Real/lm	System/W	CCT		Driver MADE IN ITALY	mA
R61S/3K/20/W/1	4600	3788	40	3000K	20°	ON-OFF	1050
R61S/4K/20/W/1	4850	3994	40	4000K	20°	ON-OFF	1050
R61S/3K/20/W/3	4600	3788	40	3000K	20°	DALI	1050
R61S/4K/20/W/3	4850	3994	40	4000K	20°	DALI	1050
R61S/3K/30/W/1	4600	3952	40	3000K	30°	ON-OFF	1050
R61S/4K/30/W/1	4850	4166	40	4000K	30°	ON-OFF	1050
R61S/3K/30/W/3	4600	3952	40	3000K	30°	DALI	1050
R61S/4K/30/W/3	4850	4166	40	4000K	30°	DALI	1050
R61S/3K/48/W/1	4600	3918	40	3000K	48°	ON-OFF	1050
R61S/4K/48/W/1	4850	4131	40	4000K	48°	ON-OFF	1050
R61S/3K/48/W/3	4600	3918	40	3000K	48°	DALI	1050
R61S/4K/48/W/3	4850	4131	40	4000K	48°	DALI	1050
R61S/3K/65/W/1	4600	3199	40	3000K	65°	ON-OFF	1050
R61S/4K/65/W/1	4850	3373	40	4000K	65°	ON-OFF	1050
R61S/3K/65/W/3	4600	3199	40	3000K	65°	DALI	1050
R61S/4K/65/W/3	4850	3373	40	4000K	65°	DALI	1050



Mind in Italy

Proiettore LED multipotenza orientabile per installazione su binario eurostandard.

Multipower adjustable LED projector for eurostandard track installation.

Projecteur LED multi puissance pour installation sur rails eurostandard.

Multipower verstellbarer LED-Projektor für Eurostandard Spur- Installation.

LED COB SAMSUNG LC026D G3 CRI>90 McAdam Step3

SAMSUNG COB LED LC026D G3 CRI>90 McAdam Step3

LED COB SAMSUNG LC026D G3 CRI>90 McAdam Step3

SAMSUNG COB LED LC026D G3 CRI>90 McAdam Step3

Lifetime 50.000h (L80B10).

Lifetime 50.000h (L80B10).

Durée de vie 50.000h (L80B10).

Lebensdauer 50.000 Std. (L80B10).

Corpo in alluminio verniciato a polvere goffrato, bianco o nero.

White matt or black matt powder-coated aluminium body.

Corps en aluminium peint par poudrage blanc ou noir mat.

Matt, weisser oder schwarzer Pulverlack-Aluminium-Körper.

Ottiche 20°-30°-48°-65° in PMMA ad alta efficienza.

20°-30°-48°-65° optics in high efficiency PMMA.

Lentilles 20°-30°-48°-65° en PMMA à haut rendement.

20°-30°-48°-65° Abstrahlwinkel, aus qualitativ hochwertigem PMMA.

Alimentatore multipotenza dip-switch 220-240V 50/60Hz incluso.

Multi-power dip-switch 220-240V 50/60Hz power supply included.

Dip-switch multi-puissance 220-240V 50/60Hz alimentation inclus.

Multi-Power-Dip-Schalter 220-240V 50/60Hz Netzteil enthalten.

Garanzia prodotto: driver Made in Italy 5 anni

Product guarantee: 5 years with Made in Italy driver.

Garantie produit: 5 ans avec alimentation Made in Italy.

Produktgarantie: 5 Jahre with Made in Italy Treiber.

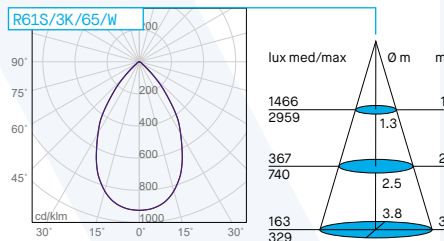
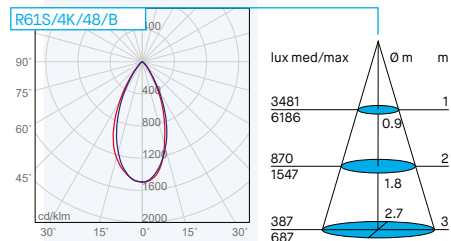
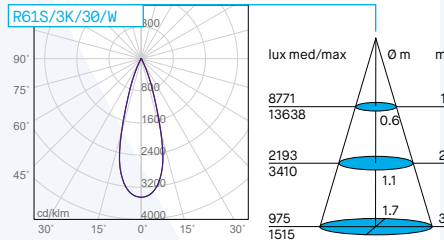
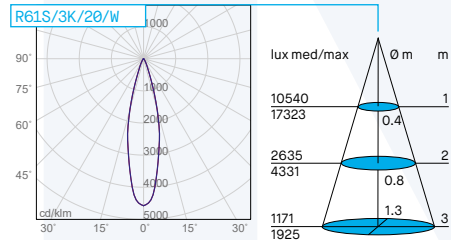

5 ANNI DI GARANZIA - YEARS OF GUARANTEE

Gestione della luce / Light management, see [cat.42](#)

DALI	Bluetooth BLL	Bluetooth CASAMBI
✓	✓	✓

Correnti di pilotaggio con driver ON-OFF e DALI — Driving currents with ON-OFF and DALI drivers - Courants d'alimentation avec alimentation ON-OFF et DALI - Stromzufuhr mit ON-OFF- und DALI-Treiber

Driver ON-OFF mA	Nominal/lm 3K-4K	Real/lm 3K-4K - 48°	System/W
850	3800-4000	3236-3407	32
900	4000-4250	3407-3620	34
950	4200-4450	3577-3790	36
1000	4400-4650	3748-3961	38
1050	4600-4850	3918-4131	40

Driver DALI mA	Nominal/lm 3K-4K	Real/lm 3K-4K - 48°	System/W
850	3800-4000	3236-3407	32
900	4000-4250	3407-3620	34
950	4200-4450	3577-3790	36
1000	4400-4650	3748-3961	38
1050	4600-4850	3918-4131	40

E' possibile selezionare la potenza desiderata tramite il selettore sul driver / Possibility to select the desired power via the selector on the driver

Possibilité de selectionner la puissance souhaitée sur le switch de l'alimentation / Möglichkeit mit dem Treiber Stromstärke auszuwählen.

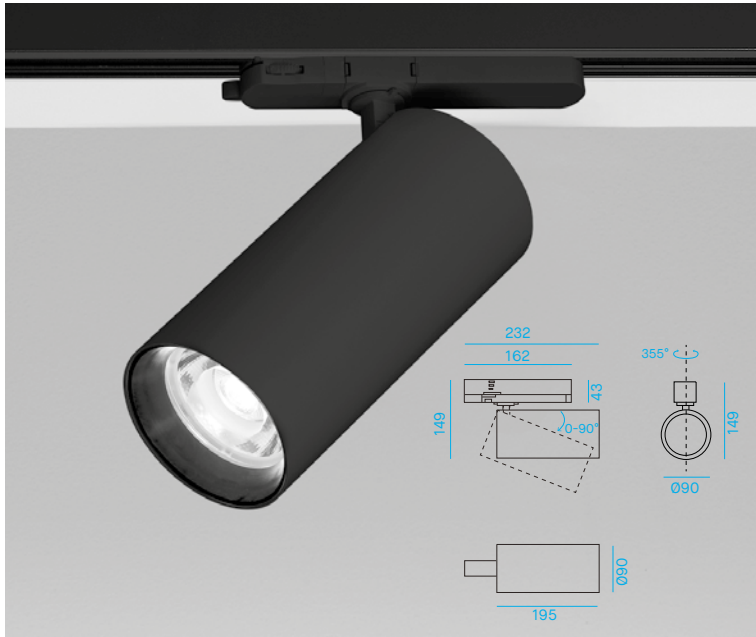

R61S SMART

Code (black)	Nominal/lm	Real/lm	System/W	CCT		Driver MADE IN ITALY	mA
R61S/3K/20/B/1	4600	3788	40	3000K	20°	ON-OFF	1050
R61S/4K/20/B/1	4850	3994	40	4000K	20°	ON-OFF	1050
R61S/3K/20/B/3	4600	3788	40	3000K	20°	DALI	1050
R61S/4K/20/B/3	4850	3994	40	4000K	20°	DALI	1050
R61S/3K/30/B/1	4600	3952	40	3000K	30°	ON-OFF	1050
R61S/4K/30/B/1	4850	4166	40	4000K	30°	ON-OFF	1050
R61S/3K/30/B/3	4600	3952	40	3000K	30°	DALI	1050
R61S/4K/30/B/3	4850	4166	40	4000K	30°	DALI	1050
R61S/3K/48/B/1	4600	3918	40	3000K	48°	ON-OFF	1050
R61S/4K/48/B/1	4850	4131	40	4000K	48°	ON-OFF	1050
R61S/3K/48/B/3	4600	3918	40	3000K	48°	DALI	1050
R61S/4K/48/B/3	4850	4131	40	4000K	48°	DALI	1050
R61S/3K/65/B/1	4600	3199	40	3000K	65°	ON-OFF	1050
R61S/4K/65/B/1	4850	3373	40	4000K	65°	ON-OFF	1050
R61S/3K/65/B/3	4600	3199	40	3000K	65°	DALI	1050
R61S/4K/65/B/3	4850	3373	40	4000K	65°	DALI	1050



Mind in Italy

Proiettore LED multipotenza orientabile per installazione su binario eurostandard.

LED COB SAMSUNG LC026D G3 CRI>90
McAdam Step3

Lifetime 50.000h (L80B10).

Corpo in alluminio verniciato a polvere goffrato, bianco o nero.

Ottiche 20°-30°-48°-65° in PMMA ad alta efficienza.

Alimentatore multipotenza dip-switch 220-240V 50/60Hz incluso.

Garanzia prodotto:
driver Made in Italy 5 anni

Multipower adjustable LED projector for eurostandard track installation.

SAMSUNG COB LED LC026D G3 CRI>90
McAdam Step3

Lifetime 50.000h (L80B10).

White matt or black matt powder-coated aluminium body.

20°-30°-48°-65° optics in high efficiency PMMA.

Multi-power dip-switch 220-240V 50/60Hz power supply included.

Product guarantee:
5 years with Made in Italy driver.

Projecteur LED multi puissance pour installation sur rails eurostandard.

LED COB SAMSUNG LC026D G3 CRI>90
McAdam Step3

Durée de vie 50.000h (L80B10).

Corps en aluminium peint par poudrage blanc ou noir mat.

Lentilles 20°-30°-48°-65° en PMMA à haut rendement.

Dip-switch multi-puissance 220-240V 50/60Hz alimentation inclus.

Garantie produit: 5 ans avec alimentation Made in Italy.

Multipower verstellbarer LED-Projektor für Eurostandard Spur- Installation.

SAMSUNG COB LED LC026D G3 CRI>90
McAdam Step3

Lebensdauer 50.000 Std. (L80B10).

Matt, weisser oder schwarzer Pulverlack-Aluminium-Körper.

20°-30°-48°-65° Abstrahlwinkel, aus qualitativ hochwertigem PMMA.

Multi-Power-Dip-Schalter 220-240V 50/60Hz Netzteil enthalten.

Produktgarantie:
5 Jahre with Made in Italy Treiber.

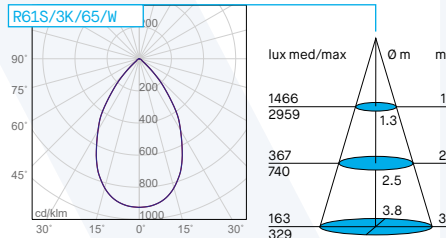
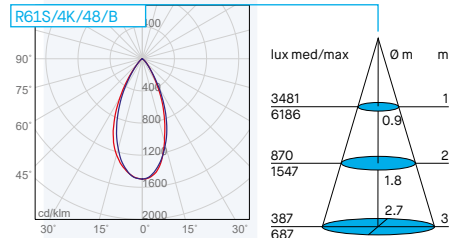
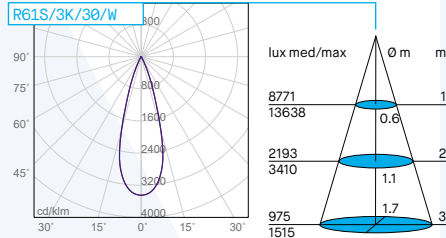
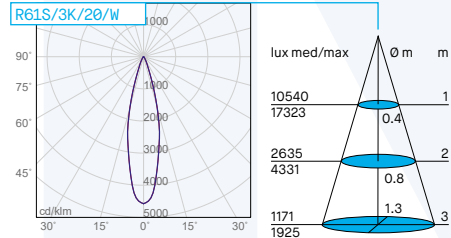

Gestione della luce / Light management, see [cat.42](#)

DALI	Bluetooth BLL	Bluetooth CASAMBI
✓	✓	✓

Correnti di pilotaggio con driver ON-OFF e DALI — Driving currents with ON-OFF and DALI drivers — Courants d'alimentation avec alimentation ON-OFF et DALI - Stromzufuhr mit ON-OFF- und DALI-Treiber

Driver ON-OFF mA	Nominal/lm 3K-4K	Real/lm 3K-4K - 48°	System/W
850	3800-4000	3236-3407	32
900	4000-4250	3407-3620	34
950	4200-4450	3577-3790	36
1000	4400-4650	3748-3961	38
1050	4600-4850	3918-4131	40

Driver DALI mA	Nominal/lm 3K-4K	Real/lm 3K-4K - 48°	System/W
850	3800-4000	3236-3407	32
900	4000-4250	3407-3620	34
950	4200-4450	3577-3790	36
1000	4400-4650	3748-3961	38
1050	4600-4850	3918-4131	40

E' possibile selezionare la potenza desiderata tramite il selettore sul driver / Possibility to select the desired power via the selector on the driver

Possibilité de selectionner la puissance souhaitée sur le switch de l'alimentation / Möglichkeit mit dem Treiber Stromstärke auszuwählen.

Accessori su richiesta — Accessories upon request - Accessoires sur demande - Zubehör auf Anfrage



HONEYCOMB/R60S

Griglia antiabbagliamento per R60S e R61S. Griglia antiabbagliamento a nido d'ape per riduzione del 30% del flusso e del fattore di abbagliamento.

Antiglare honeycomb for R60S and R61S. Honeycomb anti-dazzle screen to reduce the glare and the flux of 30%.

Grille en nid d'abeilles anti-éblouissement pour R60S et R61S. Grille en nid d'abeilles anti-éblouissement pour réduire le flux lumineux et l'éblouissement du 30%.

Wabenförmige Antiblendgitter für R60S und R61S. Wabenförmige Antiblendgitter reduzieren den Lichtfluss um 30%.



FLAP/R60S/B

Alette rompiflusso per R60S e R61S. Alette direzionali in acciaio di colore nero goffrato.

Barn doors for R60S and R61S. Barn doors in black embossed steel.

Volets directionnels pour R60S et R61S. Volets directionnels en acier noir mat.

Blendklappen für R60S und R61S. Blendklappen in schwarz geprägtem Stahl.



CONE45/R60S/_

Cono 45° bianco o nero asimmetrico per R60S e R61S.

Asymmetric white or black cone 45° for R60S and R61S.

Cône blanc o noir 45° asymétrique pour R60S et R61S.

Weisser oder Schwarzer Konus 45°, asymmetrisch für R60S und R61S.

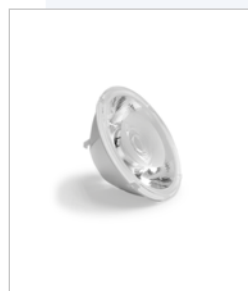

LENS/R60S/_

Lente intercambiabile in PMMA. Aperture 20° - 30° - 48° - 65°. Idonee per R60S e R61S.

PMMA interchangeable lens. 20° - 30° - 48° - 65° beams. Suitable for R60S and R61S.

Lentille interchangeable 20° - 30° - 48° - 65°. Compatible pour R60S et R61S.

Austauschbare Linsen in PMMA 20° - 30° - 48° - 65° Strahler. Passend für R60S und R61S.

Code	Descrizione	Description	Description	Beschreibung
LENS/R60S/20	Lente intercambiabile 20° per R60S e R61S	Interchangeable 20° lens for R60S and R61S	Lentille interchangeable 20° pour R60S et R61S	Austauschbare Linsen 20° Strahler für R60S und R61S
LENS/R60S/30	Lente intercambiabile 30° per R60S e R61S	Interchangeable 30° lens for R60S and R61S	Lentille interchangeable 30° pour R60S et R61S	Austauschbare Linsen 30° Strahler für R60S und R61S
LENS/R60S/48	Lente intercambiabile 48° per R60S e R61S	Interchangeable 48° lens for R60S and R61S	Lentille interchangeable 48° pour R60S et R61S	Austauschbare Linsen 48° Strahler für R60S und R61S
LENS/R60S/65	Lente intercambiabile 65° per R60S e R61S	Interchangeable 65° lens for R60S and R61S	Lentille interchangeable 65° pour R60S et R61S	Austauschbare Linsen 65° Strahler für R60S und R61S
HONEYCOMB/R60S	Griglia antiabbagliamento per R60S e R61S	Antiglare honeycomb for R60S and R61S	Grille en nid d'abeilles anti-éblouissement	Wabenförmige Antiblendgitter für R60S und R61S
FLAP/R60S/B	Alette rompiflusso per R60S e R61S	Barn doors for R60S and R61S	Volets directionnels pour R60S et R61S	Blendklappen für R60S und R61S
CONE45/R60S/W	Cono 45° bianco asimmetrico per R60S e R61S	White cone 45° asymmetric for R60S and R61S	Cône blanc 45° asymétrique pour R60S et R61S	Weisser Konus 45°, asymmetrisch für R60S und R61S
CONE45/R60S/B	Cono 45° nero asimmetrico per R60S e R61S	Black cone 45° asymmetric for R60S and R61S	Cône noir 45° asymétrique pour R60S et R61S	Schwarzer Konus, 45° asymmetrisch für R60S und R61S