

R59S SMART

Code (white)	Nominal/lm	Real/lm	System/W	CCT	Beam	Driver MADE IN ITALY	mA
R59S/3K/25/W/1	2250	1358	21	3000K	25°	ON-OFF	500
R59S/4K/25/W/1	2300	1388	21	4000K	25°	ON-OFF	500
R59S/3K/25/W/3	2250	1358	21	3000K	25°	DALI	500
R59S/4K/25/W/3	2300	1388	21	4000K	25°	DALI	500
R59S/3K/40/W/1	2250	1765	21	3000K	40°	ON-OFF	500
R59S/4K/40/W/1	2300	1804	21	4000K	40°	ON-OFF	500
R59S/3K/40/W/3	2250	1765	21	3000K	40°	DALI	500
R59S/4K/40/W/3	2300	1804	21	4000K	40°	DALI	500
R59S/3K/60/W/1	2250	1134	21	3000K	60°	ON-OFF	500
R59S/4K/60/W/1	2300	1159	21	4000K	60°	ON-OFF	500
R59S/3K/60/W/3	2250	1134	21	3000K	60°	DALI	500
R59S/4K/60/W/3	2300	1159	21	4000K	60°	DALI	500

R59S/_/_/_/W/10	21	BLUETOOTH BLL	500
R59S/_/_/_/W10P	21	BLUETOOTH BLL PIR	500
R59S/_/_/_/W/11	21	BLUETOOTH CASAMBI	500

Utilizzabile tramite APP BLL PLUS o CASAMBI (per sistemi IOS e Android)
 It can be controlled via APP BLL PLUS or CASAMBI (for IOS and Android systems)
 Possibilité de contrôle remote via APP BLL PLUS ou CASAMBI (pour systèmes Apple et Android)
 Steuerbar mit APP BLL PLUS oder CASAMBI (für Apple- und Android-Systeme).

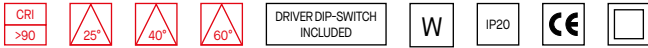

Mind in Italy

Proiettore LED multipotenza orientabile per installazione su binario eurostandard.

Multipower adjustable LED projector for eurostandard track installation.

Projecteur LED multi puissance pour installation sur rails eurostandard.

Multipower verstellbarer LED-Projektor für Eurostandard Spur- Installation.

LED COB SAMSUNG LC026D G3 CRI>90 McAdam Step3

SAMSUNG COB LED LC026D G3 CRI>90 McAdam Step3

LED COB SAMSUNG LC026D G3 CRI>90 McAdam Step3

SAMSUNG COB LED LC026D G3 CRI>90 McAdam Step3

Lifetime 50.000h (L80B10).

Lifetime 50.000h (L80B10).

Durée de vie 50.000h (L80B10).

Lebensdauer 50.000 Std. (L80B10).

Corpo in alluminio verniciato a polvere goffrato, bianco o nero.

White matt or black matt powder-coated aluminium body.

Corps en aluminium peint par poudrage blanc ou noir mat.

Matt, weisser oder schwarzer Pulverlack-Aluminium-Körper.

Ottiche 25°-40°-60° in PMMA ad alta efficienza.

25°-40°-60° optics in high efficiency PMMA.

Lentilles 25°-40°-60° en PMMA à haut rendement.

25°-40°-60° Abstrahlwinkel, aus qualitativ hochwertigem PMMA.

BLUETOOTH BLL PIR: Apparechio dotato di sensore di movimento. Distanza di rilevamento: 5 metri

BLUETOOTH BLL PIR: Luminaire with motion sensor. Detection distance: 5m

BLUETOOTH BLL PIR: Appareil avec détecteur de présence. Distance détection: 5m

BLUETOOTH BLL PIR: Leuchte mit Bewegungsmelder. Distanz: 5m

Alimentatore multipotenza dip-switch 220-240V 50/60Hz incluso.

Multi-power dip-switch 220-240V 50/60Hz power supply included.

Dip-switch multi-puissance 220-240V 50/60Hz alimentation inclus.

Multi-Power-Dip-Schalter 220-240V 50/60Hz Netzteil enthalten.

Garanzia prodotto: driver Made in Italy 5 anni

Product guarantee: 5 years with Made in Italy driver.

Garantie produit: 5 ans avec alimentation Made in Italy.

Produktgarantie: 5 Jahre with Made in Italy Treiber.

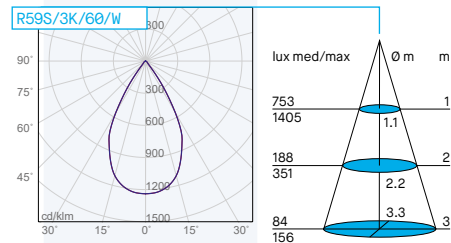
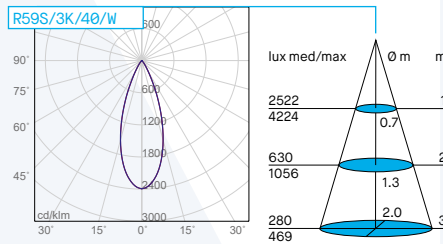
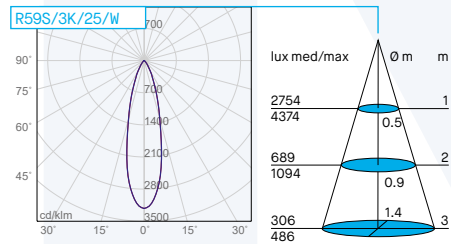

Gestione della luce / Light management, see [cat.42](#)

	Bluetooth BLL	Bluetooth CASAMBI
DALI	✓	✓

Correnti di pilotaggio con driver ON-OFF e DALI — Driving currents with ON-OFF and DALI drivers — Courants d'alimentation avec alimentation ON-OFF et DALI — Stromzufuhr mit ON-OFF- und DALI-Treiber

Driver ON-OFF mA	Nominal/lm 3K-4K	Real/lm 3K-4K - 40°	System/W	Driver DALI mA	Nominal/lm 3K-4K	Real/lm 3K-4K - 40°	System/W
250	1150-1250	902-980	11	--	--	--	--
350	1600-1650	1255-1295	15	350	1600-1650	1255-1295	15
450	2000-2100	1568-1647	18.5	450	2000-2100	1568-1647	18.5
500	2250-2300	1765-1804	21	500	2250-2300	1765-1804	21

E' possibile selezionare la potenza desiderata tramite il selettore sul driver / Possibility to select the desired power via the selector on the driver

Possibilité de selectionner la puissance souhaitée sur le switch de l'alimentation / Möglichkeit mit dem Treiber Stromstärke auszuwählen.

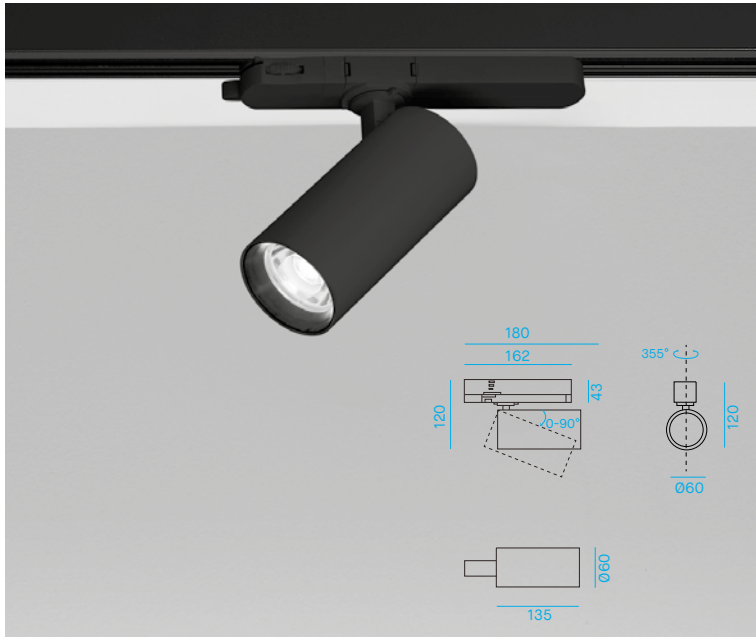

R59S SMART

Code (black)	Nominal/lm	Real/lm	System/W	CCT	Beam	Driver MADE IN ITALY	mA
R59S/3K/25/B/1	2250	1358	21	3000K	25°	ON-OFF	500
R59S/4K/25/B/1	2300	1388	21	4000K	25°	ON-OFF	500
R59S/3K/25/B/3	2250	1358	21	3000K	25°	DALI	500
R59S/4K/25/B/3	2300	1388	21	4000K	25°	DALI	500
R59S/3K/40/B/1	2250	1765	21	3000K	40°	ON-OFF	500
R59S/4K/40/B/1	2300	1804	21	4000K	40°	ON-OFF	500
R59S/3K/40/B/3	2250	1765	21	3000K	40°	DALI	500
R59S/4K/40/B/3	2300	1804	21	4000K	40°	DALI	500
R59S/3K/60/B/1	2250	1134	21	3000K	60°	ON-OFF	500
R59S/4K/60/B/1	2300	1159	21	4000K	60°	ON-OFF	500
R59S/3K/60/B/3	2250	1134	21	3000K	60°	DALI	500
R59S/4K/60/B/3	2300	1159	21	4000K	60°	DALI	500

R59S/_/_/_/B/10	21	BLUETOOTH BLL	500
R59S/_/_/_/B10P	21	BLUETOOTH BLL PIR	500
R59S/_/_/_/B/11	21	BLUETOOTH CASAMBI	500

Utilizzabile tramite APP BLL PLUS o CASAMBI (per sistemi iOS e Android)
 It can be controlled via APP BLL PLUS or CASAMBI (for iOS and Android systems)
 Possibilité de contrôle remote via APP BLL PLUS ou CASAMBI (pour systèmes Apple et Android)
 Steuerbar mit APP BLL PLUS oder CASAMBI (für Apple- und Android-Systeme).

Proiettore LED multipotenza orientabile per installazione su binario eurostandard.

LED COB SAMSUNG LC026D G3 CRI>90 McAdam Step3

Lifetime 50.000h (L80B10).

Corpo in alluminio verniciato a polvere goffrato, bianco o nero.

Ottiche 25°-40°-60° in PMMA ad alta efficienza.

BLUETOOTH BLL PIR: Apparecchio dotato di sensore di movimento. Distanza di rilevamento: 5 metri

Alimentatore multipotenza dip-switch 220-240V 50/60Hz incluso.

Garanzia prodotto: driver Made in Italy 5 anni

Multipower adjustable LED projector for eurostandard track installation.

SAMSUNG COB LED LC026D G3 CRI>90 McAdam Step3

Lifetime 50.000h (L80B10).

White matt or black matt powder-coated aluminium body.

25°-40°-60° optics in high efficiency PMMA.

BLUETOOTH BLL PIR: Luminaire with motion sensor. Detection distance: 5m

Multi-power dip-switch 220-240V 50/60Hz power supply included.

Product guarantee: 5 years with Made in Italy driver.

Projecteur LED multi puissance pour installation sur rails eurostandard.

LED COB SAMSUNG LC026D G3 CRI>90 McAdam Step3

Durée de vie 50.000h (L80B10).

Corps en aluminium peint par poudrage blanc ou noir mat.

Lentilles 25°-40°-60° en PMMA à haut rendement.

BLUETOOTH BLL PIR: Appareil avec détecteur de présence. Distance détection: 5m

Dip-switch multi-puissance 220-240V 50/60Hz alimentation inclus.

Garantie produit: 5 ans avec alimentation Made in Italy.

Multipower verstellbarer LED-Projektor für Eurostandard Spur- Installation.

SAMSUNG COB LED LC026D G3 CRI>90 McAdam Step3

Lebensdauer 50.000 Std. (L80B10).

Matt, weißer oder schwarzer Pulverlack-Aluminium-Körper.

25°-40°-60° Abstrahlwinkel, aus qualitativ hochwertigem PMMA.

BLUETOOTH BLL PIR: Leuchte mit Bewegungsmelder. Distanz: 5m

Multi-Power-Dip-Schalter 220-240V 50/60Hz Netzteil enthalten.

Produktgarantie: 5 Jahre with Made in Italy Treiber.

Mind in Italy

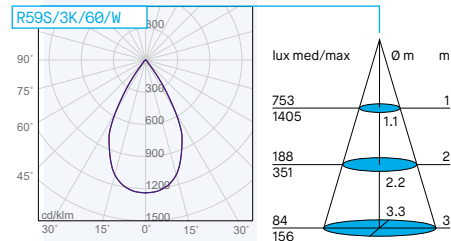
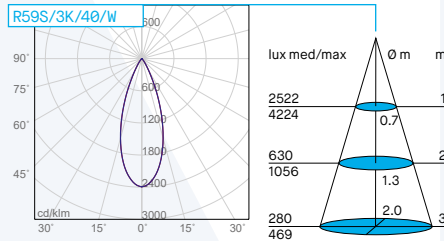
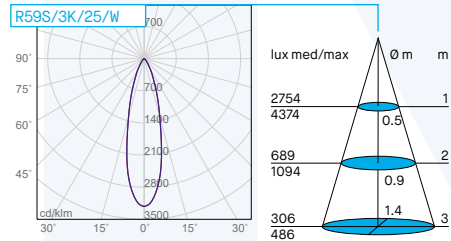

Gestione della luce / Light management, see [cat.42](#)

DALI	Bluetooth BLL	Bluetooth CASAMBI
✓	✓	✓

Correnti di pilotaggio con driver ON-OFF e DALI — Driving currents with ON-OFF and DALI drivers — Courants d'alimentation avec alimentation ON-OFF et DALI — Stromzufuhr mit ON-OFF- und DALI-Treiber

Driver ON-OFF mA	Nominal/lm 3K-4K	Real/lm 3K-4K - 40°	System/W	Driver DALI mA	Nominal/lm 3K-4K	Real/lm 3K-4K - 40°	System/W
250	1150-1250	902-980	11	--	--	--	--
350	1600-1650	1255-1295	15	350	1600-1650	1255-1295	15
450	2000-2100	1568-1647	18.5	450	2000-2100	1568-1647	18.5
500	2250-2300	1765-1804	21	500	2250-2300	1765-1804	21

E' possibile selezionare la potenza desiderata tramite il selettore sul driver / Possibility to select the desired power via the selector on the driver

Possibilité de selectionner la puissance souhaitée sur le switch de l'alimentation / Möglichkeit mit dem Treiber Stromstärke auszuwählen.

Accessori su richiesta — Accessories upon request - Accessoires sur demande - Zubehör auf Anfrage



HONEYCOMB/R59S

Griglia antiabbagliamento per R59S. Griglia antiabbagliamento a nido d'ape per riduzione del 30% del flusso e del fattore di abbagliamento.

Antiglare honeycomb for R59S. Honeycomb anti-dazzle screen to reduce the glare and the flux of 30%.

Grille en nid d'abeilles anti-éblouissement pour R59S. Grille en nid d'abeilles anti-éblouissement pour réduire le flux lumineux et l'éblouissement du 30%.

Wabenförmige Antiblendgitter für R59S. Wabenförmige Antiblendgitter reduzieren den Lichtfluss um 30%.



LENS/R59S/_

Lente intercambiabile in PMMA. Aperture 25° - 40° - 60°. Idonee per R59S.

PMMA interchangeable lens. 25° - 40° - 60° beams. Suitable for R59S.

Lentille interchangeable 25° - 40° - 60°. Compatible pour R59S.

Austauschbare Linsen in PMMA 25° - 40° - 60° Strahler. Passend für R59S.

Code	Descrizione	Description	Description	Beschreibung
LENS/R59S/25	Lente intercambiabile 25° per R59S	Interchangeable 25° lens for R59S	Lentille interchangeable 25° pour R59S	Austauschbare Linsen 25° Strahler für R59S
LENS/R59S/40	Lente intercambiabile 40° per R59S	Interchangeable 40° lens for R59S	Lentille interchangeable 40° pour R59S	Austauschbare Linsen 40° Strahler für R59S
LENS/R59S/60	Lente intercambiabile 60° per R59S	Interchangeable 60° lens for R59S	Lentille interchangeable 60° pour R59S	Austauschbare Linsen 60° Strahler für R59S
HONEYCOMB/R59S	Griglia antiabbagliamento per R59S	Antiglare honeycomb for R59S	Grille en nid d'abeilles anti-éblouissement	Wabenförmige Antiblendgitter für R59S