



M3SA/C

Code	Nominal/lm	Real/lm	LED/W	System/W	CCT	Beam
M3SA/CM/3K25/_	2200	1642	25	28	3000K	20°
M3SA/CM/4K25/_	2400	1791	25	28	4000K	20°
M3SA/CF/3K25/_	2200	1497	25	28	3000K	40°
M3SA/CF/4K25/_	2400	1632	25	28	4000K	40°
M3SA/CM/3K38/_	3400	2538	38	40	3000K	20°
M3SA/CM/4K38/_	3600	2687	38	40	4000K	20°
M3SA/CF/3K38/_	3400	2312	38	40	3000K	40°
M3SA/CF/4K38/_	3600	2448	38	40	4000K	40°



Incasso orientabile quadrato a LED per installazione a soffitto.

LED COB CITIZEN CRI>90 (range potenza: 25W-38W).

Life time 50.000h (L70B10).

Corpo in alluminio pressofuso. Modulo LED IP54.

Cornice in alluminio verniciato bianco con staffe di fissaggio regolabili per soffitti di spessore diverso.

Doppio sistema ottico con lente e riflettore che migliora il comfort visivo. UGR<19 o UGR<16 a seconda del modello.

Disponibili accessori intercambiabili: - cornice trimless per soffitti di spessore 12,5-25 mm; - riflettore in policarbonato in cinque finiture diverse; - griglia anti abbagliamento.

Alimentatore 220-240V - 50/60Hz incluso. (ON-OFF, PUSH/DIM 1-10V, DALI)

Square adjustable recessed LED fitting for false ceiling installation.

CITIZEN COB LED CRI>90 (power range: 25W-38W).

Life time 50.000h (L70B10).

Body in die-cast aluminium. LED Module IP54.

Frame in white painted aluminium with adjustable fixing brackets adjustable to different depth of ceiling.

Double optical system with lens and reflector to improve the visual comfort. UGR<19 or UGR<16 depending on model.

Interchangeable accessories available upon request: - trimless frame for ceiling of depth 12,5-25mm; - polycarbonate reflector in 5 different finishing; - anti-glare grid.

220-240V - 50/60Hz power supply included. (ON-OFF, PUSH/DIM 1-10V, DALI)

Appareil à encastrer LED orientable carré pour installation dans faux-plafond

LED COB CITIZEN IRC>90 (gamme puissances: 25W-38W).

Durée de vie 50.000h (L70B10).

Corps en fonderie d'aluminium. Module LED IP54.

Cadre en aluminium peint blanc avec patentes de fixation réglables pour différentes épaisseurs de plafond.

Double système optique avec lentille et réflecteur pour un meilleur confort visuel. UGR<19 ou UGR<16 Selon le modèle.

Disponibles accessoires interchangeables: - anneau trimless pour plafond d'épaisseur 12,5-25 mm; - réflecteur en polycarbonate en cinq finitions différentes; - grille anti éblouissement.

Alimentation 220-240V - 50/60Hz incluse. (ON-OFF, PUSH/DIM 1-10V, DALI)

Quadratischer LED-Einbau für Deckeninstallation i

LED COB CITIZEN CRI>90 (Leistungsbereich: 25W-38W).

Lebensdauer 50.000h (L70B10).

Aluminium-Druckguss Körper. LED-Modul IP54.

Weiss lackierter Aluminium Rahmen mit einstellbaren Klammern für verschiedene Deckendichte.

Dual-optisches System mit einer Linse und Reflektor die den Sehkomfort verbessern. UGR<19 or UGR<16 Gemäss Modell.

Austauschbare Zubehöre erhältlich: - Rahmen Trimless für 12,5-25 mm Deckendichte; - Polycarbonat Reflektor in fünf verschiedenen Ausführungen; - Entblendungs Gitter.

Netzgerät 220-240V - 50 / 60Hz enthalten. (ON-OFF, PUSH/DIM 1-10V, DALI)

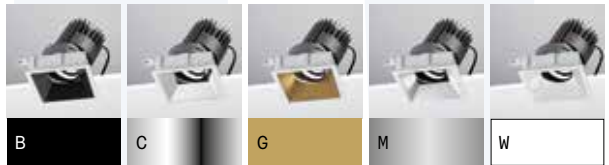
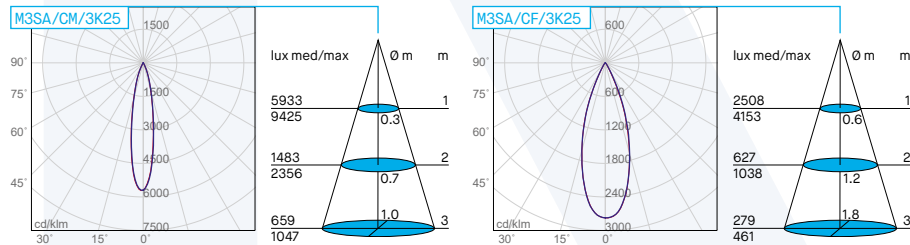

Completare il codice prodotto identificando il driver - Choose the driver version you need to complete the product's code

Code	Descrizione	Description	Description	Beschreibung
M3SA/_/_/_/_/1	Con driver ON-OFF Made in Italy	With Made in Italy ON-OFF driver	Avec alimentation ON-OFF Made in Italy	Mit Driver ON-OFF Made in Italy
M3SA/_/_/_/_/2	Con driver PUSH/DIM 1-10V Made in Italy	With Made in Italy PUSH/DIM 1-10V driver	Avec alimentation PUSH/DIM 1-10V Made in Italy	Mit Driver PUSH/DIM 1-10V Made in Italy
M3SA/_/_/_/_/3	Con driver DALI Made in Italy	With Made in Italy DALI driver	Avec alimentation DALI Made in Italy	Mit Driver DALI Made in Italy
M3SA/_/_/_/_/6	Con driver ON-OFF	With ON-OFF driver	Avec alimentation ON-OFF	Mit Driver ON-OFF

Accessori disponibili su richiesta - Accessories available upon request

Code	Descrizione	Description
5861	Interfaccia Bluetooth regolazione tramite APP o pulsante NA. Solo per versione /2	Bluetooth interface, control via App or NO button. Only for version /2
5864	Interfaccia Wi-Fi regolazione tramite gateway Zigbee (non fornito). Solo per versione /2	Wi-Fi interface through Zigbee gateway (not included). Only for version /2

Kit emergenza disponibile su richiesta - Emergency kit available upon request - Kit éclairage secouru disponible sur demande - Notfall Kit auf Anfrage erhältlich.

Code	Descrizione	Description	Description	Beschreibung
KIT EM/LED/1H	Kit emergenza per LED 1 ora - Batt.7.2V - 1.5Ah	Emergency kit for LED 1 hour - Batt.7.2V - 1.5Ah	Kit éclairage secouru pour LED 1 heure - Batt.7.2V - 1.5Ah	Notfall Kit für LED 1 Stunde - Batt.7.2V - 1.5Ah
KIT EM/LED/3H	Kit emergenza per LED 3 ore - Batt.7.2V - 4Ah	Emergency kit for LED 3 hours - Batt.7.2V - 4Ah	Kit éclairage secouru pour LED 3 heures - Batt.7.2V - 4Ah	Notfall Kit für LED 3 Stunden - Batt.7.2V - 4Ah

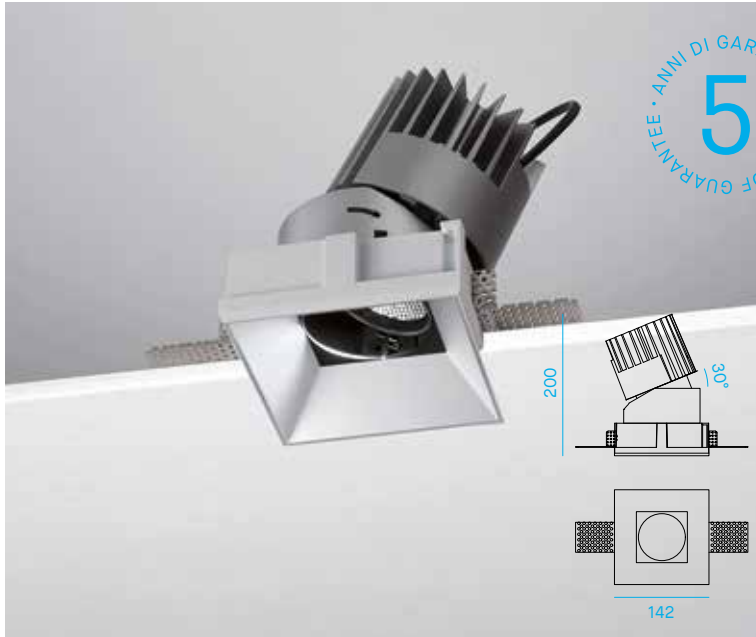

M3SA/T

Code	Nominal/lm	Real/lm	LED/W	System/W	CCT	Beam
M3SA/TM/3K25/_	2200	1642	25	28	3000K	20°
M3SA/TM/4K25/_	2400	1791	25	28	4000K	20°
M3SA/TF/3K25/_	2200	1497	25	28	3000K	40°
M3SA/TF/4K25/_	2400	1632	25	28	4000K	40°
M3SA/TM/3K38/_	3400	2538	38	40	3000K	20°
M3SA/TM/4K38/_	3600	2687	38	40	4000K	20°
M3SA/TF/3K38/_	3400	2312	38	40	3000K	40°
M3SA/TF/4K38/_	3600	2448	38	40	4000K	40°



Incasso orientabile quadrato a LED per installazione a soffitto.

Square adjustable recessed LED fitting for false ceiling installation.

Appareil à encastrer LED orientable carré pour installation dans faux-plafond

Quadratischer LED-Einbau für Deckeninstallation

LED COB CITIZEN CRI>90 (range potenza: 25W-38W).

CITIZEN COB LED CRI>90 (power range: 25W-38W).

LED COB CITIZEN IRC>90 (gamme puissances: 25W-38W).

LED COB CITIZEN CRI>90 (Leistungsbereich: 25W-38W).

Life time 50.000h (L70B10).

Life time 50.000h (L70B10).

Durée de vie 50.000h (L70B10).

Lebensdauer 50.000h (L70B10).

Corpo in alluminio pressofuso. Modulo LED IP54.

Body in die-cast aluminium. LED Module IP54.

Corps en fonderie d'aluminium. Module LED IP54.

Aluminium-Druckguss Körper. LED-Modul IP54.

Cornice in alluminio verniciato bianco con staffe di fissaggio regolabili per soffitti di spessore diverso.

Frame in white painted aluminium with adjustable fixing brackets adjustable to different depth of ceiling.

Cadre en aluminium peint blanc avec patentes de fixation réglables pour différentes épaisseurs de plafond.

Weiss lackierter Aluminium Rahmen mit einstellbaren Klammern für verschiedene Deckendichte.

Doppio sistema ottico con lente e riflettore che migliora il comfort visivo. UGR<19 o UGR<16 a seconda del modello.

Double optical system with lens and reflector to improve the visual comfort. UGR<19 or UGR<16 depending on model.

Double système optique avec lentille et réflecteur pour un meilleur confort visuel. UGR<19 or UGR<16 Selon le modèle.

Dual-optisches System mit einer Linse und Reflektor die den Sehkomfort verbessern. UGR<19 or UGR<16 Gemäss Modell.

Disponibili accessori intercambiabili: - cornice trimless per soffitti di spessore 12,5-25 mm; - riflettore in policarbonato in cinque finiture diverse; - griglia anti abbagliamento.

Interchangeable accessories available upon request: - trimless frame for ceiling of depth 12,5-25mm; - polycarbonate reflector in 5 different finishing; - anti-glare grid.

Disponibles accessoires interchangeables: - anneau trimless pour plafond d'épaisseur 12,5-25 mm; - réflecteur en polycarbonate en cinq finitions différentes; - grille anti éblouissement.

Austauschbare Zubehöre erhältlich: - Rahmen Trimless für 12,5-25 mm Deckendichte; - Polycarbonat Reflektor in fünf verschiedenen Ausführungen; - Entblendungs Gitter.

Alimentatore 220-240V - 50/60Hz incluso. (ON-OFF, PUSH/DIM 1-10V, DALI)

220-240V - 50/60Hz power supply included. (ON-OFF, PUSH/DIM 1-10V, DALI)

Alimentation 220-240V - 50/60Hz incluse. (ON-OFF, PUSH/DIM 1-10V, DALI)

Netzgerät 220-240V - 50 / 60Hz enthalten. (ON-OFF, PUSH/DIM 1-10V, DALI)

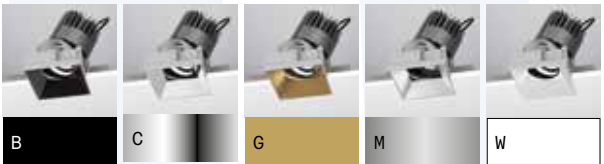
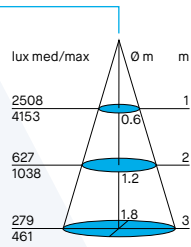
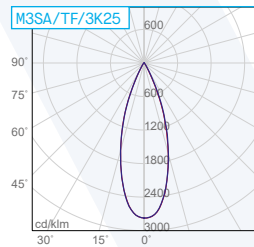
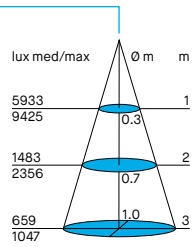
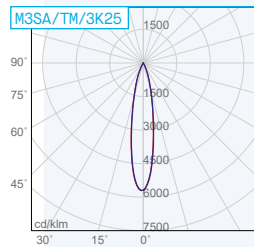

Completare il codice prodotto identificando il driver - Choose the driver version you need to complete the product's code

Code	Descrizione	Description	Description	Beschreibung
M3SA/_/_/_/_/1	Con driver ON-OFF Made in Italy	With Made in Italy ON-OFF driver	Avec alimentation ON-OFF Made in Italy	Mit Driver ON-OFF Made in Italy
M3SA/_/_/_/_/2	Con driver PUSH/DIM 1-10V Made in Italy	With Made in Italy PUSH/DIM 1-10V driver	Avec alimentation PUSH/DIM 1-10V Made in Italy	Mit Driver PUSH/DIM 1-10V Made in Italy
M3SA/_/_/_/_/3	Con driver DALI Made in Italy	With Made in Italy DALI driver	Avec alimentation DALI Made in Italy	Mit Driver DALI Made in Italy
M3SA/_/_/_/_/6	Con driver ON-OFF	With ON-OFF driver	Avec alimentation ON-OFF	Mit Driver ON-OFF

Accessori disponibili su richiesta - Accessories available upon request

Code	Descrizione	Description
5861	Interfaccia Bluetooth regolazione tramite APP o pulsante NA. Solo per versione /2	Bluetooth interface, control via App or NO button. Only for version /2
5864	Interfaccia Wi-Fi regolazione tramite gateway Zigbee (non fornito). Solo per versione /2	Wi-Fi interface through Zigbee gateway (not included). Only for version /2

Kit emergenza disponibile su richiesta - Emergency kit available upon request - Kit éclairage secouru disponible sur demande - Notfall Kit auf Anfrage erhältlich.

Code	Descrizione	Description	Description	Beschreibung
KIT EM/LED/1H	Kit emergenza per LED 1 ora - Batt.7.2V - 1.5Ah	Emergency kit for LED 1 hour - Batt.7.2V - 1.5Ah	Kit éclairage secouru pour LED 1 heure - Batt.7.2V - 1.5Ah	Notfall Kit für LED 1 Stunde - Batt.7.2V - 1.5Ah
KIT EM/LED/3H	Kit emergenza per LED 3 ore - Batt.7.2V - 4Ah	Emergency kit for LED 3 hours - Batt.7.2V - 4Ah	Kit éclairage secouru pour LED 3 heures - Batt.7.2V - 4Ah	Notfall Kit für LED 3 Stunden - Batt.7.2V - 4Ah