



A LED wall equipment, perfect for general or accent lighting. Featuring a square shape and a clean, elegant design, Tak is suitable for applications in both the commercial and residential spheres.

MATERIALS:

Die-cast aluminium body alloy EN AB47100.
High-reflectance and tempered glass with sandblasting treatment (dot-less effect)

FINISHING:

Matt white, grey, cor-ten or anthracite.
Outdoor-use treatment with epoxy-polyester powder coating, pre-treatment for oxide protection with nanoceramics process for pre-varnish passivation of iron, galvanised steel and aluminium. Salty fog test resistance up to 1000H.

INSTALLATION:

The fixture is usually installed using a fixing plate, screws and plugs, supplied with gel-filled junction box for exterior cabling

EMISSIONS:

The fixture is provided with 3 optics: large, medium and narrow.

Apparecchio a plafone da soffitto, ideale per illuminazione generale e di accento. Caratterizzato da una forma quadrata e da un design pulito ed elegante Tak è idoneo per applicazioni sia in ambito commerciale che residenziale.

MATERIALI:

Corpo in alluminio presso-fuso lega EN AB47100.
Schermo in vetro extrachiario temprato con trattamento di sabbia-tura per un effetto dot-less.

FINITURA:

Bianco opaco, grigio, cor-ten o antracite.
Trattamento di verniciatura per esterni con polveri epossidiche; pre-trattamento antiossidante con processo Nanoceramico per la passivazione in preverniciatura di materiale ferroso, zincato e alluminio. Resistenza al test di nebbia salina di 1000H.

INSTALLAZIONE:

Il prodotto viene normalmente installato con una piastra di fissaggio mediante viti e tasselli. Viene fornito con muffola stagna al gel per cablaggi in esterni.

EMISSIONE:

Il prodotto dispone di tre ottiche: fascio largo, medio e stretto.



TECHNICAL DATA

ELECTRICAL FEATURES CARATT. ELETTRICHE	POWER CONSUMPTION <i>POTENZA ASSORBITA</i>	10W (5 LED); 18W (9 LED)
	SUPPLY VOLTAGE <i>ALIMENTAZIONE</i>	230Vac 50Hz
	POWER SUPPLY UNIT <i>ALIMENTATORE</i>	Built-in <i>Integrato</i>
LIGHTING FEATURES CARATT. ILLUMINOTECNICHE	N° AND TYPE OF LED USED <i>N° E TIPO DI LED USATI</i>	5/9 LED power <i>5/9 power LED</i>
	AVERAGE LED LIFE <i>DURATA MEDIA LED</i>	75% after 50.000 h <i>75% dopo 50.000 ore</i>
	LED COLOURS AVAILABLE <i>COLORI LED DISPONIBILI</i>	White: 5000K; 4000K; 3000K; 2700K <i>Bianco: 5000K; 4000K; 3000K; 2700K</i>
	CRI <i>INDICE RESA CROMATICA CRI</i>	>80
	LIGHT BEAM AVAILABLE <i>ANGOLO DI EMISSIONE (OTTICA)</i>	S (10°); K (30°); F (70°)
	TOTAL LUMINOUS FLUX <i>FLUSSO TOTALE APPARECCHIO</i>	883 lm (3000K 9LED); 495 lm (3000K 5LED)
MECHANICAL FEATURES CARATT. MECCANICHE	DIMENSIONS <i>DIMENSIONI</i>	150x150x100 mm
	WEIGHT <i>PESO</i>	2,36 kg (Packaging included / imballo compreso)
	FINISHING <i>FINITURA</i>	Matt white; Grey; Cor-ten; Anthracite <i>Bianco opaco; Grigio; Cor-ten; Antracite</i>
	FIXING <i>FISSAGGIO</i>	With fixing plate, screws and plugs <i>Con piastra di fissaggio, viti e tasselli</i>
	BODY MATERIAL <i>MATERIALE CORPO</i>	Die-cast aluminium alloy EN AB47100 <i>Alluminio pressofuso lega EN AB47100</i>
	SCREEN MATERIAL <i>MATERIALE SCHERMO</i>	High-reflectance and tempered glass <i>Schermo in vetro extrachiario temprato</i>
	ACCESSORIES <i>ACCESSORI DISPONIBILI</i>	No accessories needed <i>Non previsti</i>
GENERAL FEATURES CARATT. GENERALI	OPERATING TEMPERATURE <i>TEMPERATURA DI ESERCIZIO</i>	0°÷ +45°
	IP RATE <i>GRADO IP</i>	IP65
	IK RATE <i>GRADO IK</i>	06
	ENERGY EFFICIENCY CLASS <i>CLASSE DI CONSUMO ENERGETICO</i>	A/A+/A++ (built-in LED lamps) in accordance with UE874/2012 A/A+/A++ (modulo LED integrato) in accordo con UE874/2012
	UGR	--
	GLOW WIRE TEST <i>GLOW WIRE TEST</i>	960°
	APPLIANCE CLASS <i>CLASSE ISOLAMENTO</i>	Class I <i>Classe I</i>
	WIRING AND CABLE <i>LUNGHEZZA CAVO E TIPO</i>	Not wired <i>Non cablato</i>
	PROTECTIONS <i>PROTEZIONI</i>	No <i>No</i>
	PHOTOBIOLOGICAL SAFETY <i>SICUREZZA FOTOBIOLOGICA</i>	Risk group 1 in accordance with EN62471:2006 <i>Gruppo rischio 1 secondo EN62471:2006</i>

PHOTOMETRIC DATA DATI FOTOMETRICI

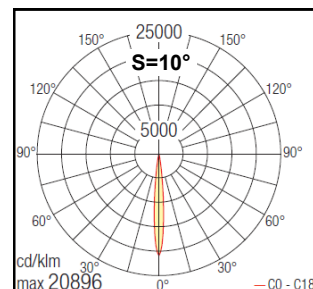
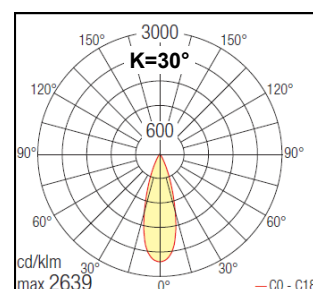
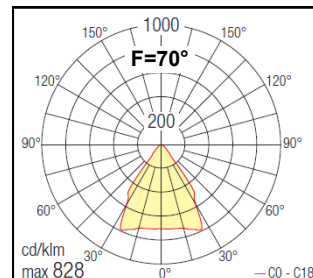

L&L Luce&Light srl
TAK 1.1

Questo dispositivo è munito di lampade a LED integrate.

Le lampade a LED di questo dispositivo non sono sostituibili

874/2012



DIMENSIONS:

DIMENSIONI:

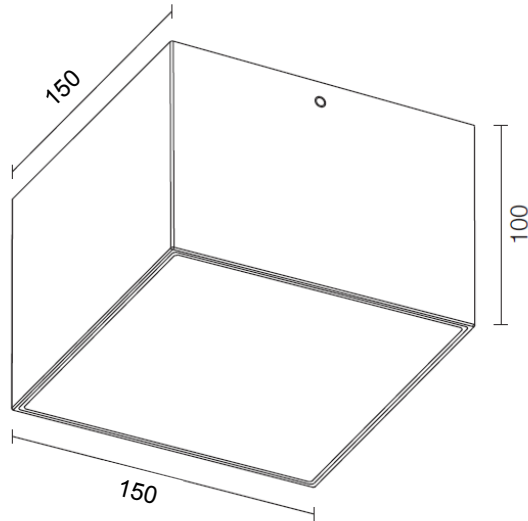





ACCESSORIES:

ACCESSORI:

No accessories needed
Accessori non previsti

FINISHES:

FINITURE:

	B Matt white <i>Bianco opaco</i>		R Cor-ten <i>Cor-ten</i>
	G Grey <i>Grigio</i>		H Anthracite <i>Antracite</i>