



Outdoor or indoor recessed LED equipment, perfect for general or scenographic lighting, for residential or hotel contexts.

MATERIALS:

Die-cast aluminium body alloy EN AB 47100.
4 mm thick high reflectance tempered glass screen with anti-scratch surface.

FINISHES:

Outdoor painted in grey Ral9006, anthracite, cor-ten and matt white Ral9003.
Outdoor-use treatment with epoxy-polyester powder coating, pre-treatment for oxide protection with nanoceramics process for pre-varnish passivation of iron, galvanised steel and aluminium. Salty fog test resistance up to 1000H.

INSTALLATION:

The fixture is usually installed with a fixing plate using screws and plugs. Optional spacer WD003x is available. It is supplied with gel-filled junction box for exterior cabling.

EMISSIONS:

Geko 6.1 has a wide range of optics: large, medium, narrow, elliptical and asymmetric.

Applique da parete a LED da esterno o da interno, ideale per illuminazione generale o scenografica, sia in ambito residenziale o alberghiero.

MATERIALI:

Corpo in alluminio presso-fuso lega EN AB 47100.
Schermo in vetro extrachiario temprato con trattamento antigraffio di spessore 4mm.

FINITURA:

Verniciato outdoor in cor-ten, bianco opaco Ral9003, antracite o grigio Ral9006.
Trattamento di verniciatura per esterni con polveri epossidiche; pre-trattamento antiossidante con processo Nanoceramico per la passivazione in preverniciatura di materiale ferroso, zincato e alluminio. Resistenza al test di nebbia salina di 1000H.

INSTALLAZIONE:

Il prodotto viene normalmente installato con una piastra di fissaggio mediante viti e tasselli; è possibile l'installazione con l'accessorio distanziale WD0300x.
Viene fornito con muffola stagna al gel per cablaggi in esterni.

EMISSIONE:

Geko 6.1 è provvisto di vari tipi di ottica: larga, media, stretta, ellittica e asimmetrica.



TECHNICAL DATA		
ELECTRICAL FEATURES CARATT. ELETTRICHE	POWER CONSUMPTION POTENZA ASSORBITA	20W
	SUPPLY VOLTAGE ALIMENTAZIONE	230Vac 50/60Hz
	POWER SUPPLY UNIT ALIMENTATORE	Built-in Integrato
	CONTROLLER DIMMERAZIONE	No dimming needed Non disponibile
	CONNECTION COLLEGAMENTO	230Vac 50/60Hz
LIGHTING FEATURES CARATT. ILLUMINOTECNICHE	N° AND TYPE OF LED USED N° E TIPO DI LED USATI	5+5 power LED (Geko 6.1) 5+5 power LED (Geko 6.1)
	AVERAGE LED LIFE DURATA MEDIA LED	75% after 50.000 h 75% dopo 50.000 ore
	LED COLOURS AVAILABLE COLORI LED DISPONIBILI	White: 5000K; 4000K; 3000K; 2700K Bianco: 5000K; 4000K; 3000K; 2700K
	CRI INDICE RESA CROMATICA CRI	75+85
	LIGHT BEAM AVAILABLE ANGOLO DI EMISSIONE (OTTICA)	Geko 6.1: T(7°); S(10°); F(30°);K(70°); W (elliptical 10°x45°); A (asymmetric)
TOTAL LUMINOUS FLUX FLUSSO TOTALE APPARECCHIO	2x521 lm (@3000K Geko 6.1)	
MECHANICAL FEATURES CARATT. MECCANICHE	DIMENSIONS DIMENSIONI	170x100x100 mm
	WEIGHT PESO	2.0 kg
	FINISHES FINITURA	Cor-ten; matt white RAL9003; antracite; grey RAL9006 Cor-ten; bianco opaco RAL9003; antracite; grigio RAL9006
	FIXING FISSAGGIO	With fixing plate, screws and plugs Con piastra di fissaggio, viti e tasselli
	BODY MATERIAL MATERIALE CORPO	Die-cast aluminium alloy EN AB 47100 Alluminio pressofuso lega EN AB 47100
	SCREEN MATERIAL MATERIALE SCHERMO	High thickness tempered glass Vetro temprato ad elevato spessore
ACCESSORIES ACCESSORI DISPONIBILI	Spaced wall mounted WD0300x Distanziale WD0300x	
GENERAL FEATURES CARATT. GENERALI	OPERATING TEMPERATURE TEMPERATURA DI ESERCIZIO	-10° ÷ +45°
	IP RATE GRADO IP	IP65
	IK RATE GRADO IK	IK07
	ENERGY EFFICIENCY CLASS CLASSE DI CONSUMO ENERGETICO	A/A+/A++ (built-in LED lamps) in accordance with UE874/2012 A/A+/A++ (modulo LED integrato) in accordo con UE874/2012
	UGR	--
	GLOW WIRE TEST GLOW WIRE TEST	960°
	SCREEN TEMPERATURE TEMPERATURA SCHERMO	Max 40°C (Ta 25°C)
	INSULATION CLASS CLASSE ISOLAMENTO	Class I Classe I
	WIRING AND CABLE LUNGHEZZA CAVO E TIPO	IP68 connection box inside Dotato di muffola per connessione stagna
	PHOTOBIOLOGICAL SAFETY SICUREZZA FOTOBIOLOGICA	Risk group 1 in accordance with EN62471:2006 Gruppo rischio 1 secondo EN62471:2006

PHOTOMETRIC DATA DATI FOTOMETRICI

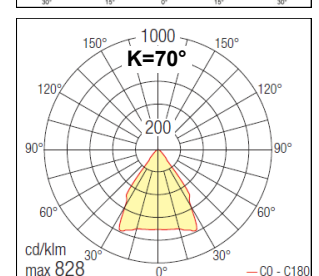
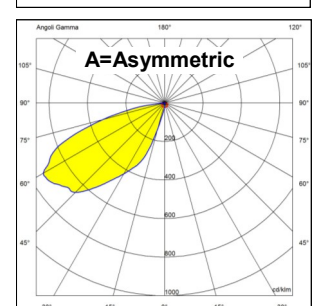
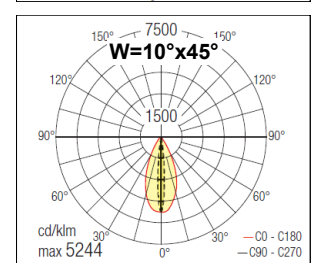
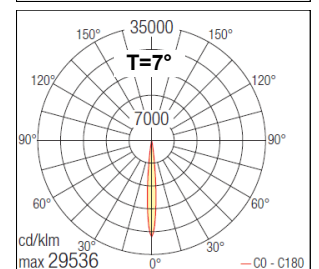
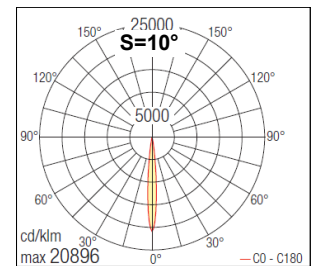
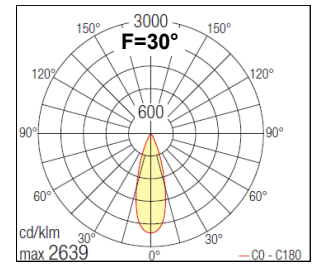



DIMENSIONS:
DIMENSIONI:

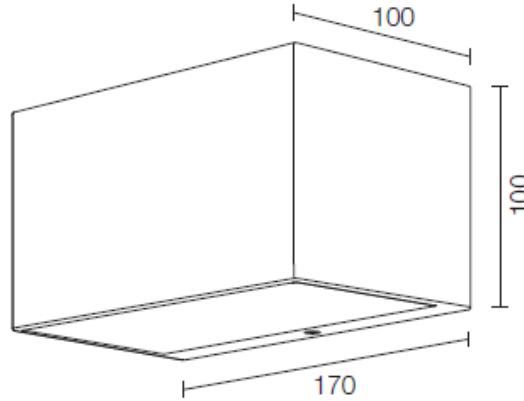

ACCESSORIES:
ACCESSORI:

WD0300x

Spaced wall mounted
Distanziale

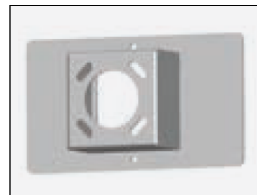
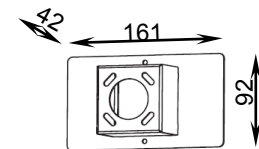

DRIVERS / POWER SUPPLIES:
ALIMENTATORI:

Built-in
Integrato

FINISHES:
FINITURE:

	B White painted <i>Bianco verniciato</i>		R Cor-ten <i>Cor-ten</i>
	N Black <i>Nero</i>		O Grey painting <i>Verniciato grigio</i>