



General characteristics

Colour	Black
Type of positions	1 > 0 - 2, key extraction in 2
Material	Polyamide
IEC degree of protection	IP66, IP67 and IP69K

Mechanical features

Mechanical life	cycles	1000000
Mounting adapter		LPXAU120
Weight	g	60

UL technical data

UL degree of protection	Type1, 2, 3R, 4, 4X, 12, 12K
-------------------------	------------------------------

Ambient conditions

Temperature	Operating temperature	min	°C	-25
		max	°C	+70
	Storage temperature	min	°C	-40
		max	°C	+85

Dimensions

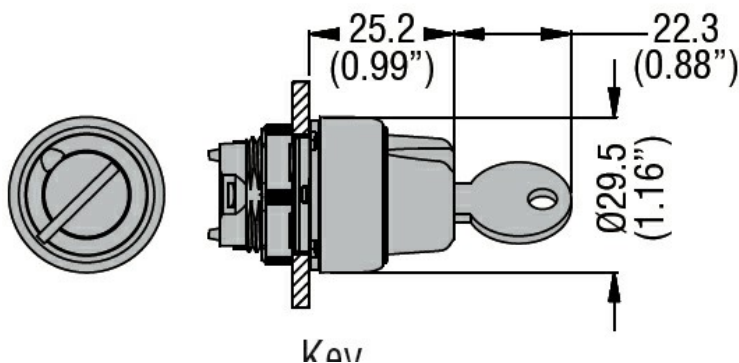

Certifications and compliance

Compliance	CSA C22.2 n° 14
	IEC/EN/BS 60947-1
	IEC/EN/BS 60947-5-1
	UL508

Certificates	CCC
	cULus

ETIM classification

ETIM 8.0

EC000222 -
Front element for
selector switch