



Caratteristiche meccaniche

Peso prodotto

g 193

Dimensioni

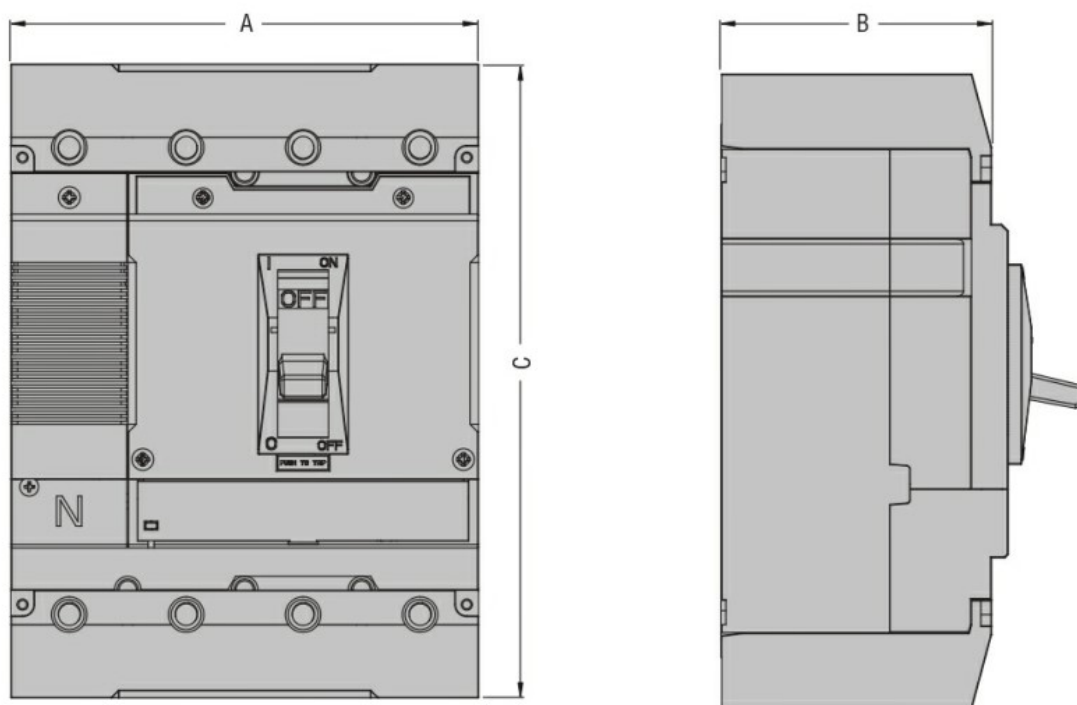

P5X8...	A [mm]	B [mm]	C [mm]
P5X831L	105	80,8	321
P5X831S			190
P5X841L	140		321

P5X841S			190
P5X832L	140	105	479
P5X832S			300
P5X842L	186		479
P5X842S			300
P5X833L	210	128	600
P5X833S			360
P5X843L	280		600
P5X843S			360

Omologazioni e conformità

Omologazioni

Classificazione ETIM

EC000066 - Power contactor, AC switching