



Caratteristiche elettriche

Taratura relè termico	A	9-14
IEC Caratteristiche di impiego ($\leq 440V$)		

le	A	14
kW	kW	5.5

Dati tecnici UL

Grado di protezione (UL)	Type 1, 12K, 4, 4X
--------------------------	--------------------

Caratteristiche meccaniche

Peso prodotto	g	1515
---------------	---	------

Condizioni ambientali

Temperatura di impiego	min	°C	-25
	max	°C	+60

Temperatura di stoccaggio	min	°C	-40
	max	°C	+70

Tolleranze e protezioni

Grado di protezione (IEC)	IP65
---------------------------	------

Dimensioni

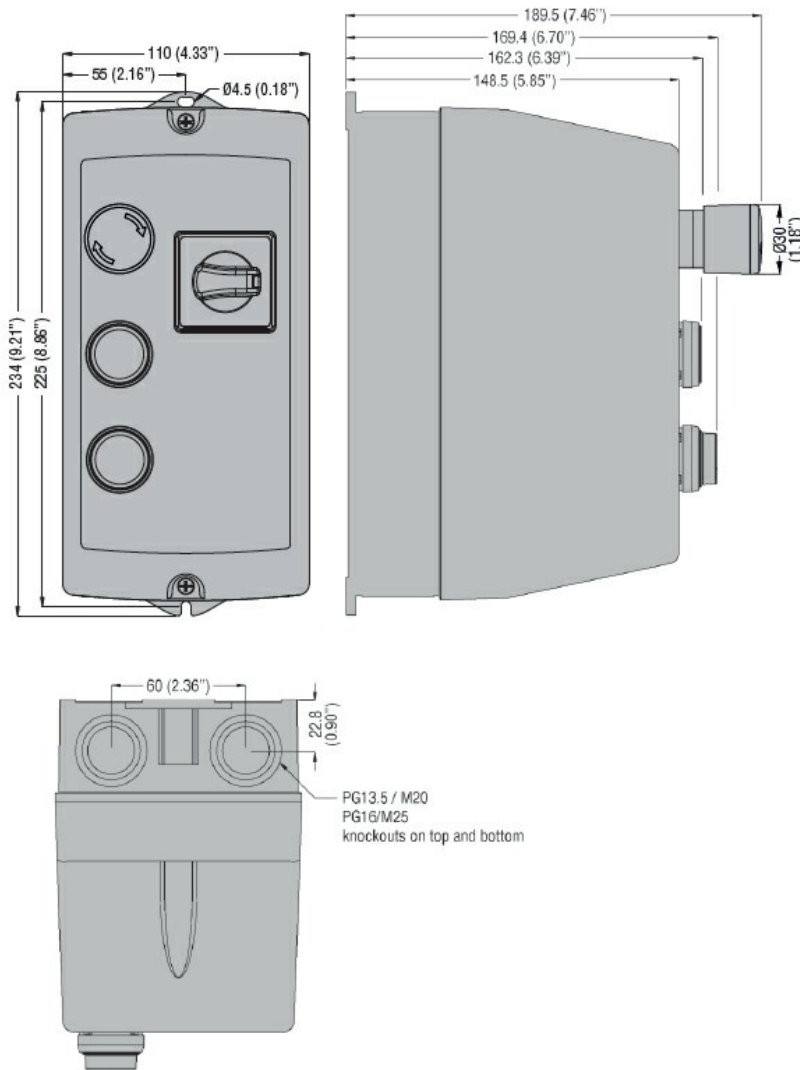

Schemi elettrici

Incorporated button control and rotary actuator for 3-phase motors

Power connection for 1-phase motors



I = Start; O = Stop; E = Emergency Stop

Omologazioni e conformità

Conformità

IEC/EN 60947-1
IEC/EN 60947-4-1

Omologazioni

EAC

Classificazione ETIM

ETIM 8.0

EC001037 -
Combinazione
starter motore