



Alimentazione ausiliaria Us

Frequenza di impiego

min	Hz	50
max	Hz	60

Potenza assorbita

max	VA	3.5
-----	----	-----

Potenza massima dissipata

	W	2.7
--	---	-----

Ingressi di misura della tensione

Tensione nominale (Ue)

fase-fase	VAC	380...415
fase-neutro	VAC	220...240

Campo di misura

fase-fase	VAC	323...456
fase-neutro	VAC	187...264

Modalità di inserzione

Via CT

Corrente

massima (Imax)

A	5
---	---

minima (Imin)

A	0.05
---	------

nominale (Iref-Ib)

A	5
---	---

di start (Ist)

mA	0.005
----	-------

di transazione (Itr)

A	0.25
---	------

Accuratezza

Energia attiva	Classe 0.5s (IEC/EN 62053-22)
Energia reattiva	Classe 2 (IEC/EN 62053-23)

Caratteristiche di uscita

Impulsi LED

pulse/kWh	1000
-----------	------

Durata impulso LED

ms	30
----	----

Isolamenti

Tensione nominale di isolamento IEC/EN

V	250
---	-----

Tensione nominale di tenuta ad impulso (Uimp)

kV	6
----	---

Tensione di tenuta alla frequenza di esercizio

kV	4
----	---

Caratteristiche meccaniche

Tipo custodia

Poliammide

Attacchi tipo

Fissi

Sezione conduttori

min	mm ²	0.2
		4 for supply voltage measurement;
max	mm ²	2.5 for current measurement
min	AWG	24

	max	AWG	12
Coppia di serraggio (Max)		Nm	0.8
		lbin	7
Fissaggio		Guida DIN	
Peso prodotto		g	332
Condizioni ambientali			
Temperatura			
Temperatura di impiego			
	min	°C	-25
	max	°C	+55
Temperatura di stoccaggio			
	min	°C	-25
	max	°C	+70
Umidità relativa		%	<80
Grado di inquinamento massimo			2

Dimensioni

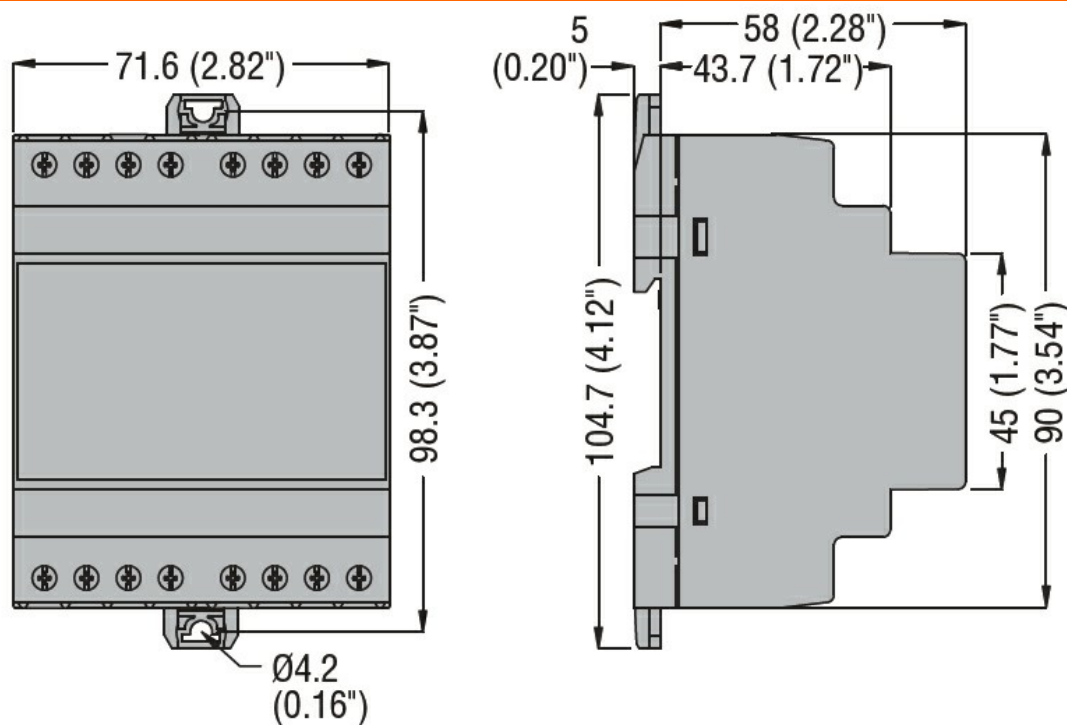

Schemi elettrici

Single-phase

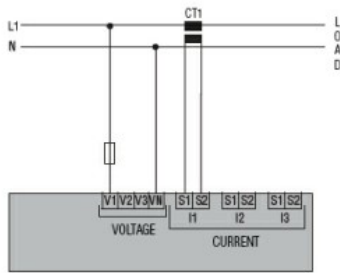

Two-phase

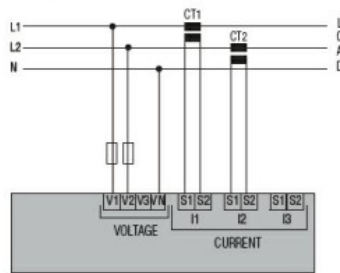

Three-phase with or without neutral

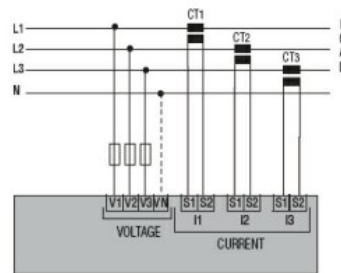

Three-phase without neutral in ARON connection

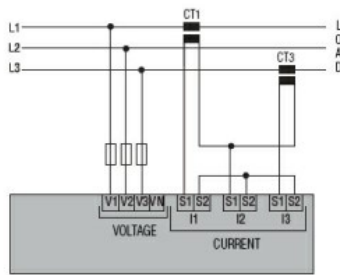
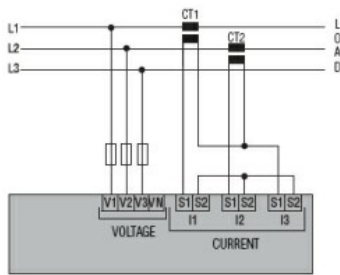

Tariff input

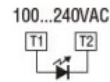

Pulse output 30VDC 50mA for DME D305 T2

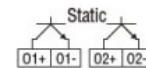

RS485 for DME D330



M-Bus for DME D332

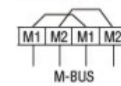

Omologazioni e conformità

Conformità

IEC/EN 50470-1

IEC/EN 61010-1

IEC/EN 61010-2-030

Omologazioni

EAC

RCM

Classificazione ETIM

ETIM 8.0

EC001506 -
Contatore di
energia elettrica