



### Caratteristiche generali

Diametro	mm - inch	70 / 2.75
Tensione di alimentazione (AC)	V	230...240
Colore		Arancione
Grado di protezione (IEC)		IP65

### Caratteristiche meccaniche

Peso prodotto	g	83
---------------	---	----

### Condizioni ambientali

Temperatura	Temperatura di impiego	min	°C	-20
		max	°C	+50

### Dimensioni

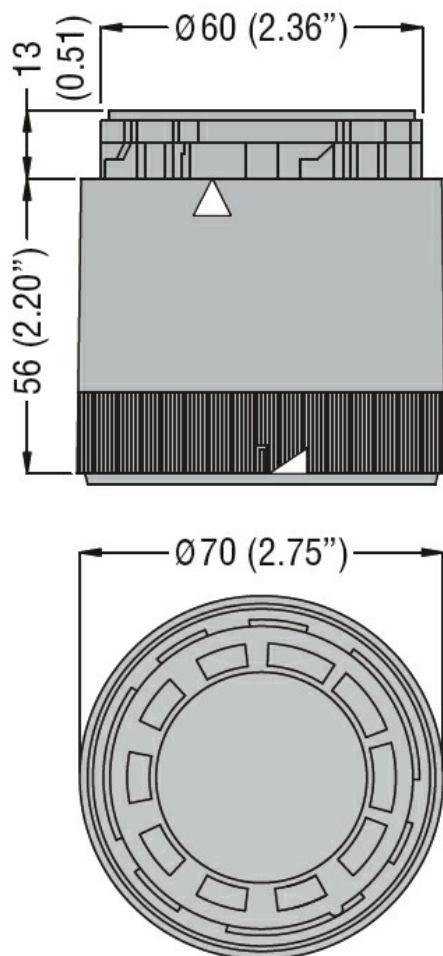

### Schemi elettrici

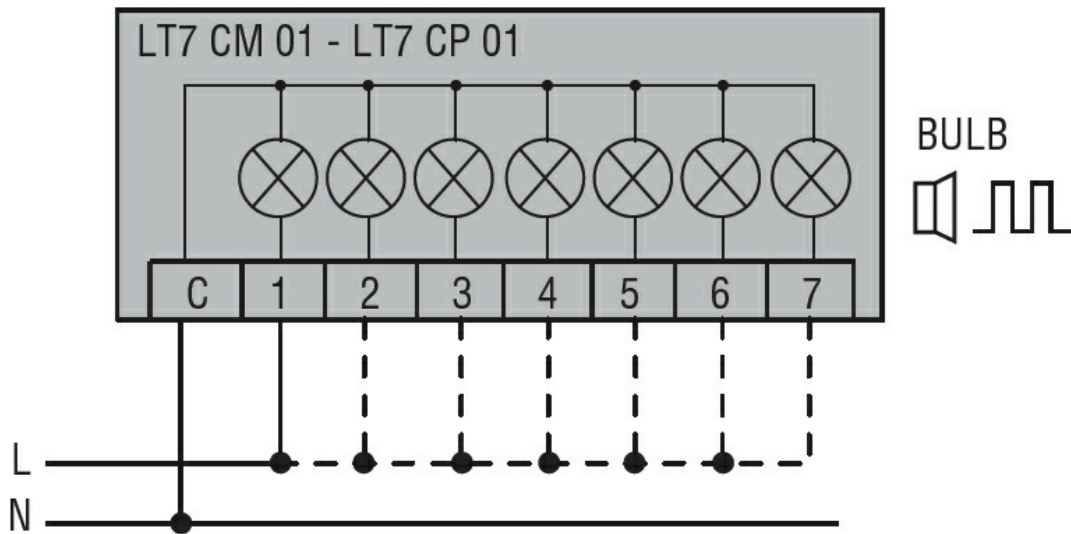

Connect terminals C and 1 as indicated to power the first module.  
If other modules are fitted, the respective terminals must be  
connected accordingly.

#### Omologazioni e conformità

##### Conformità

CSA C22.2 n° 14

IEC/EN 60947-1

IEC/EN 60947-5-1

UL508

##### Omologazioni

cULus

EAC

#### Classificazione ETIM

ETIM 8.0

EC000232 -  
Modulo ottico per  
torre di  
segnalazione