



Caratteristiche generali

Diametro	mm - inch	70 / 2.75
Tensione di alimentazione (AC)	V	110...120
Colore		Giallo
Grado di protezione (IEC)		IP65

Caratteristiche meccaniche

Peso prodotto	g	83
---------------	---	----

Condizioni ambientali

Temperatura	Temperatura di impiego	min	°C	-20
		max	°C	+50

Dimensioni

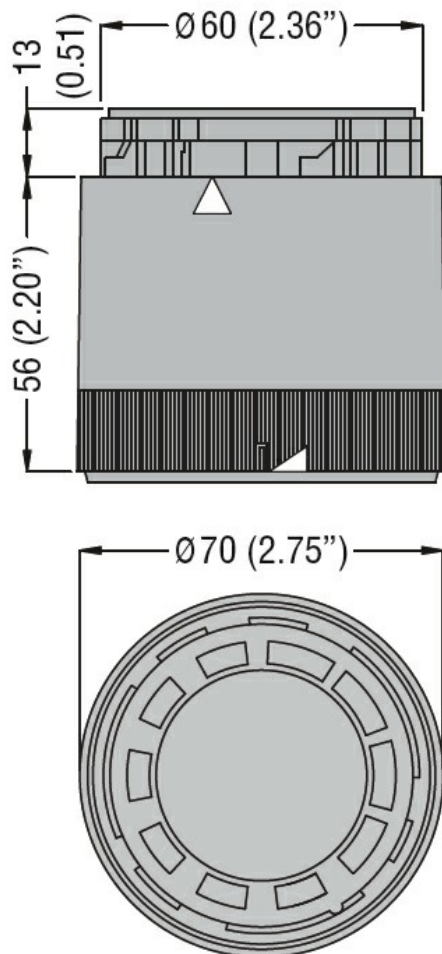

Schemi elettrici

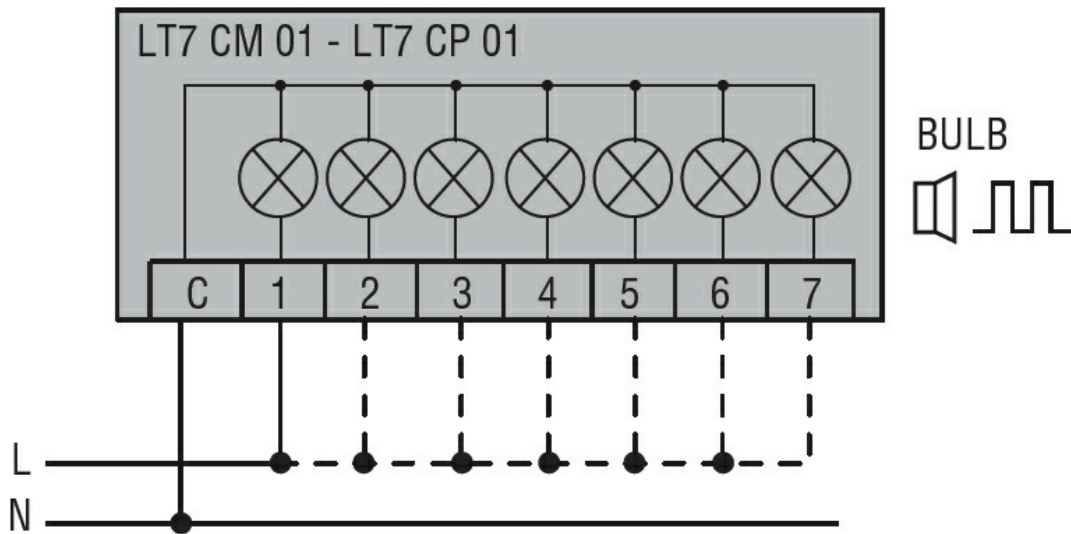

Connect terminals C and 1 as indicated to power the first module.
If other modules are fitted, the respective terminals must be
connected accordingly.

Omologazioni e conformità

Conformità

CSA C22.2 n° 14

IEC/EN 60947-1

IEC/EN 60947-5-1

UL508

Omologazioni

cULus

EAC

Classificazione ETIM

ETIM 8.0

EC000232 -
Modulo ottico per
torre di
segnalazione