



Caratteristiche generali

Diametro	mm - inch	70 / 2.75
Colore		Grigio
Grado di protezione (IEC)		IP65

Caratteristiche meccaniche

Coppia di serraggio terminali max	Nm	0.5
Attacchi vite		Morsetti

Sezione dei conduttori

AWG/Kcmil	max	16
	IEC	max mm ² 1.5

Peso prodotto	g	120
---------------	---	-----

Condizioni ambientali

Temperatura	Temperatura di impiego	min	°C	-20
		max	°C	+50

Dimensioni

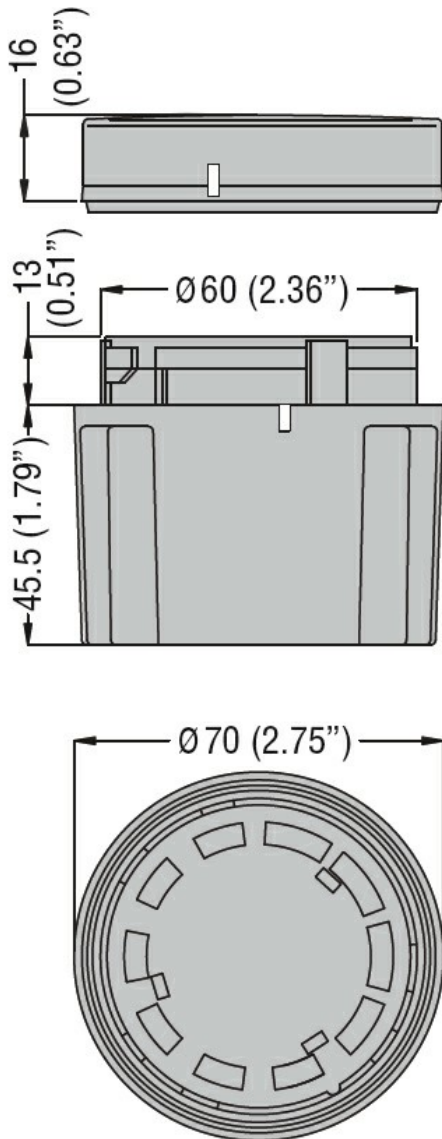

Schemi elettrici

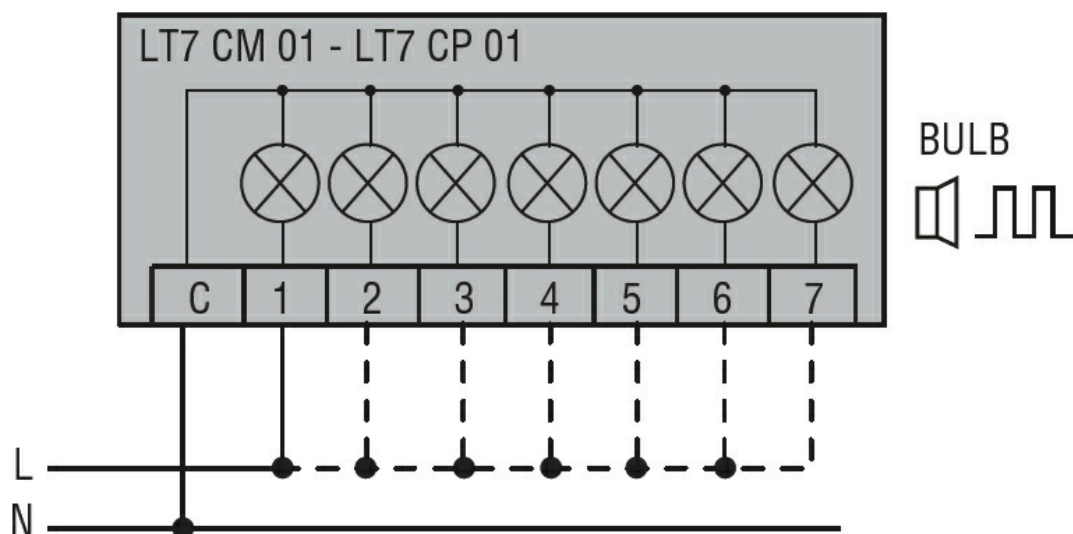

Connect terminals C and 1 as indicated to power the first module. If other modules are fitted, the respective terminals must be connected accordingly.

Omologazioni e conformità

Conformità

CSA C22.2 n°14

IEC/EN 60947-1

IEC/EN 60947-5-1

UL508

Omologazioni

cULus

EAC

Classificazione ETIM

ETIM 8.0

EC001152 -
Modulo di
connessione per
colonna
segnaletica