



General characteristics

Material

Housing Aluminium-zinc alloy

Contact characteristics

Type of contact		1NC
Thermal current I _{th}	A	10
Rated insulation voltage U _i	V	400
Short-circuit protection with fuse	Class/A	10 gG/SC QUICK FUSE
IEC Conventional free air thermal current I _{th} ≤ 40°C	A	10
Resistance per pole (average value)	mΩ	<10

Mechanical features

Operating head fixing		Fixed
Tightening torque (Max)		
Switch fixing	Nm lbin	2.5 22.1

Conductor section

AWG/Kcmil	max		14
IEC	max	mm ²	2.5

Cable connection

Screw terminal with clamp

Cable entry

PG11

Weight

g 220

Operations

Mechanical life	cycles	>10000000
Mechanical operation	cycles/h	3600

Ambient conditions

Temperature

Operating temperature	min	°C	-25
	max	°C	+70
Storage temperature	min	°C	-40
	max	°C	+70

Resistance & Protection

IP degree

Body housing IP40

Dimensions

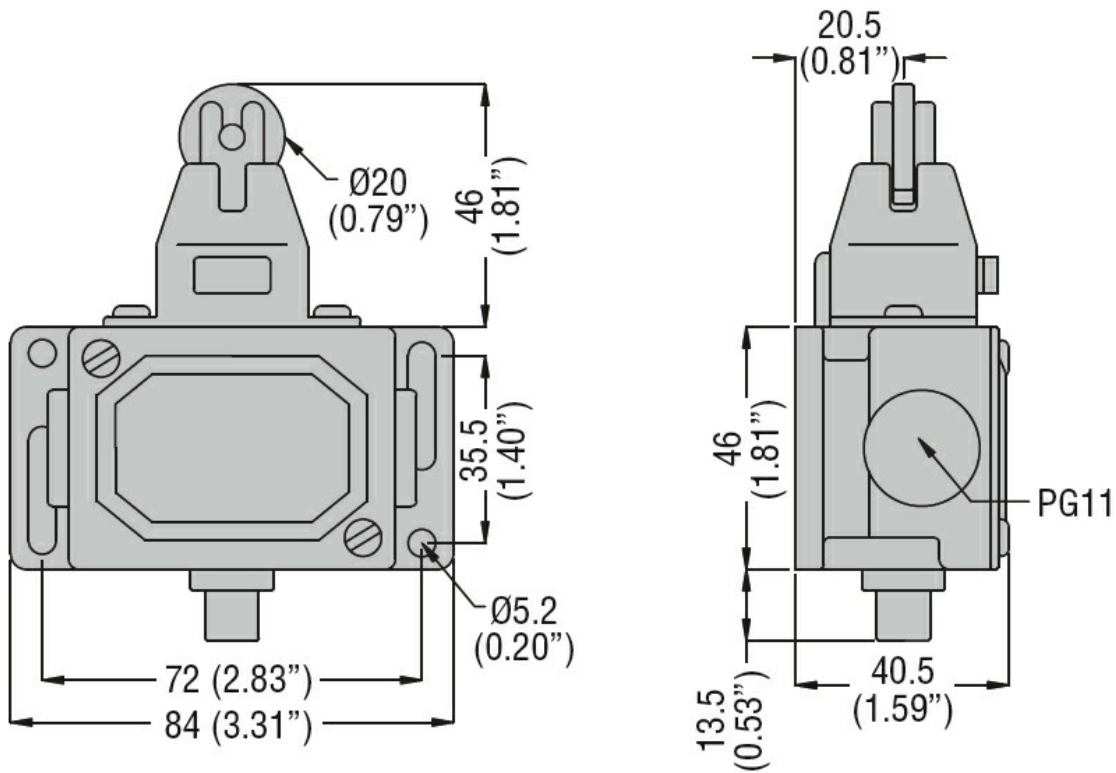

Wiring diagrams

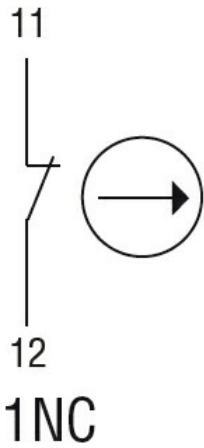

Certifications and compliance

Compliance

- EN 81-1.
- IEC/EN 60947-1
- IEC/EN 60947-5-1

Certificates

EAC

ETIM classification

ETIM 8.0

EC000030 - End switch