



Electrical features

Number of poles	Nr.	3
Rated current ($\leq 40^{\circ}\text{C}$)	A	160
Electronic overload trip adjustment range	A	64...160
Electronic short circuit trip adjustment range	A	96...1600
AC rated operation voltage U_e	V	690
Rated insulation voltage U_i	V	1000
Rated impulse withstand voltage U_{imp}	kV	8
Short circuit breaking capacity I_{cu}		
	220...240VAC 50/60Hz	kA 100
	380...415VAC 50/60Hz	kA 50
	440...460VAC 50/60Hz	kA 50
	480...500VAC 50/60Hz	kA 42
	525VAC 50/60Hz	kA 22
	660...690VAC 50/60Hz	kA 10
Short circuit breaking capacity I_{cs}		
	220...240VAC 50/60Hz	kA 100
	380...415VAC 50/60Hz	kA 50
	440...460VAC 50/60Hz	kA 50
	480...500VAC 50/60Hz	kA 42
	525VAC 50/60Hz	kA 22
	660...690VAC 50/60Hz	kA 5
Heat dissipation per pole (max)	W	16

Mechanical features

Terminals	screw tool	M8 x 20 Metric Allen key 6
Tightening torque for terminals	max max	Nm 14 lbin 125
Mounting position	normal allowable	On vertical plan Any
Fixing		Screw
Weight	g	2000
Mechanical life	cycles	25000
Electrical life	cycles	10000
Dimensions (W x H x D)	mm	105x160x86

Ambient conditions

Temperature			
Operating temperature	min max	$^{\circ}\text{C}$ $^{\circ}\text{C}$	-20 +70
Storage temperature	min	$^{\circ}\text{C}$	-40

Current derating for temperature >40°C	max	°C	+80
	50°C	°C	150
	60°C	°C	141
	70°C	°C	131

Resistance & Protection

Frontal IP degree IP20

Dimensions

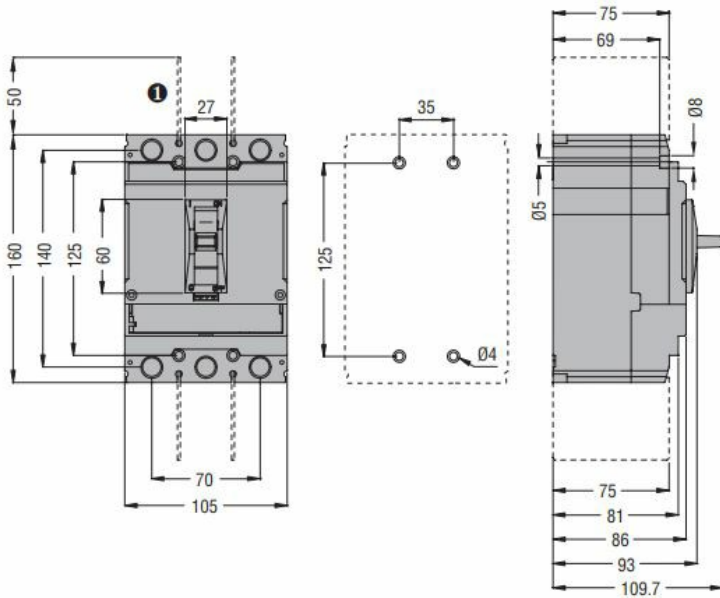

Wiring diagrams

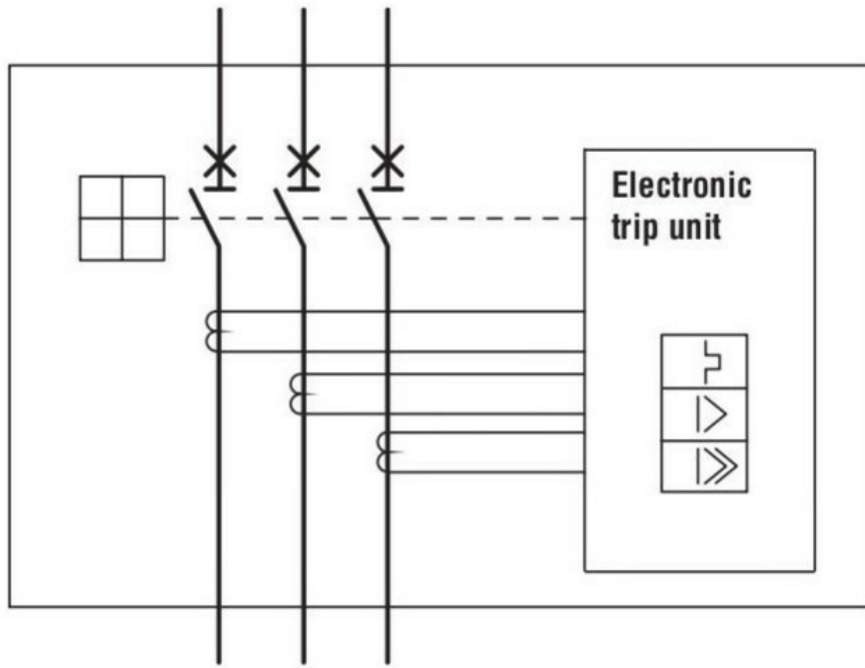

ETIM classification

EC000066 - Power contactor, AC switching