



Electrical features

Rated insulation voltage U_i IEC/EN	V	400
Rated impulse withstand voltage U_{imp}	kV	4
Rated operational voltage AC (IEC)	VAC	230/400
Rated frequency	Hz	50/60
Rated current (I_n)	A	63
Residual operation characteristic		AC
Rated residual current	mA	300
Short circuit rating (IEC)	kA	10
Rated conditional short-circuit current (I_{nc})	kA	10
Electrical life	cycles	10000

Ambient conditions

Operating temperature	min	°C	-35
	max	°C	+70
Storage temperature	min	°C	-40
	max	°C	+80
Max altitude	m		2000

Mechanical features

Operating position	normal		Vertical plan	
Fixing			35mm DIN rail	
Tightening torque for terminals	max	Nm	2	
	max	Ibin	15	
Terminals tool			Pz 2	
Conductor section	IEC	min	mm ²	2.5
		max	mm ²	35
	AWG/Kcmil	min		14
		max	kcmil	2
Mechanical life		cycles	20000	
Weight		g	326	
Frontal IP degree			IP20	
Pollution degree			2	

Dimensions

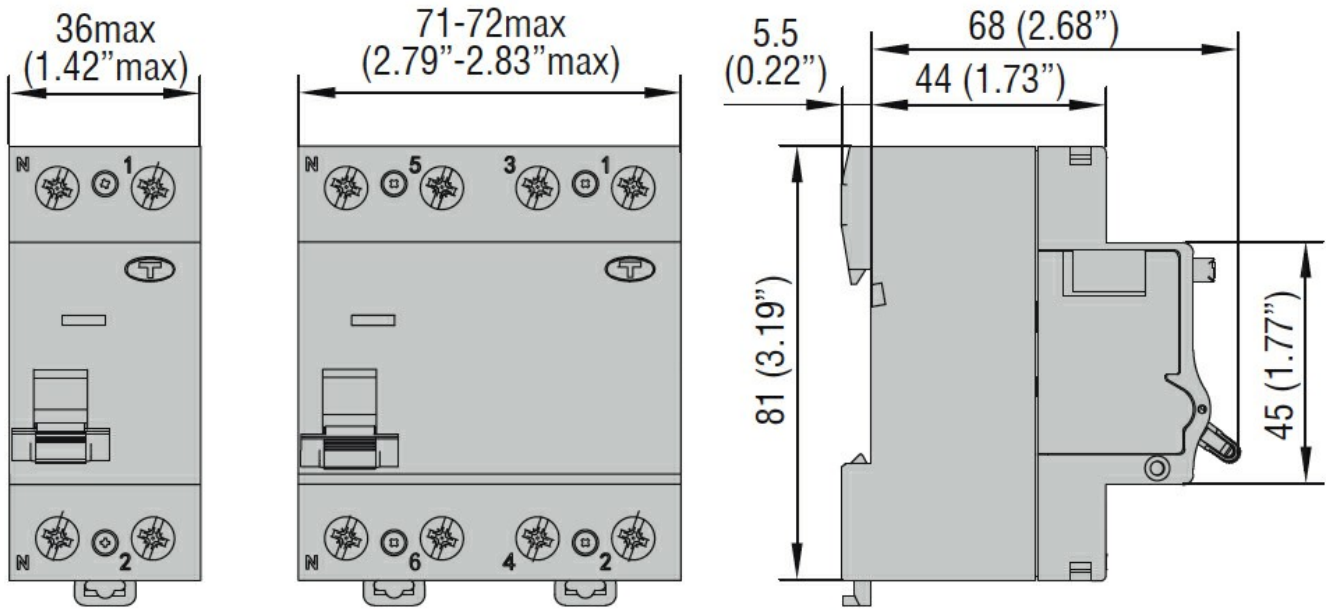

Wiring diagrams

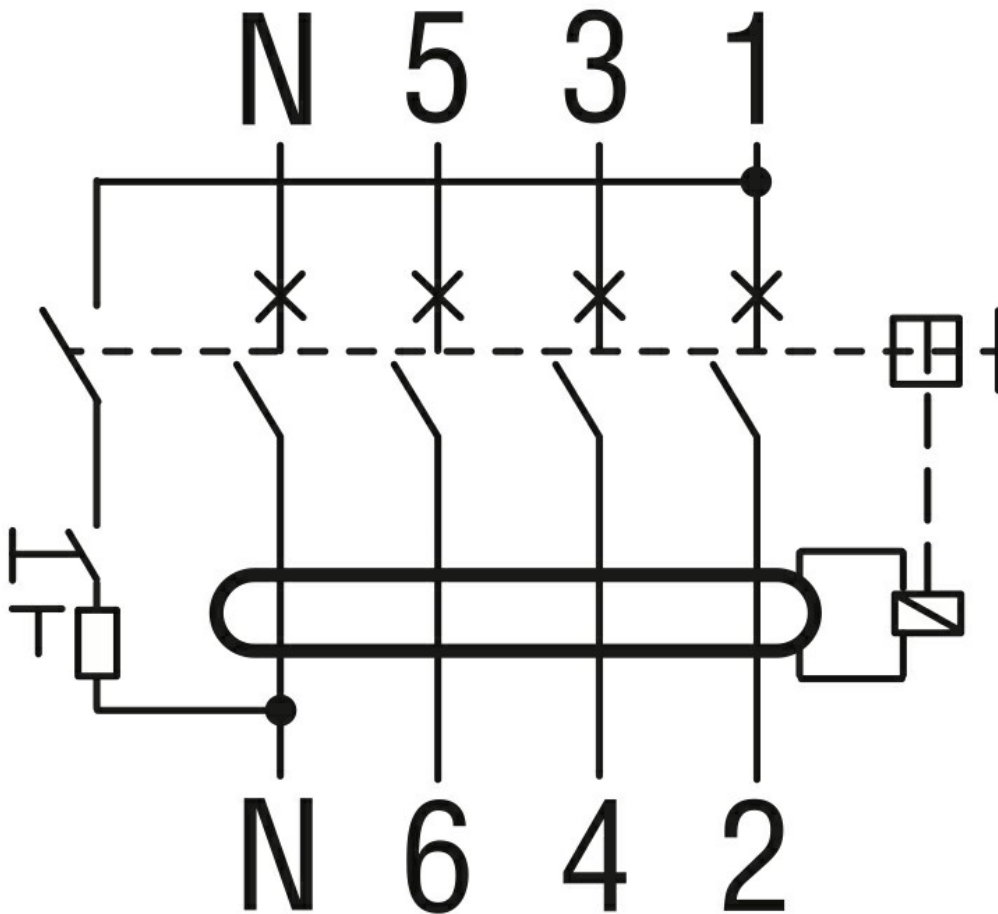

Certifications and compliance

Compliance

IEC/EN/BS 61008-1

Certifications

EAC
TÜV-Rheinland

ETIM classification

ETIM 8.0

EC000003 -
Residual current
circuit breaker
(RCCB)