



Electrical features

Rated insulation voltage U_i IEC/EN	V	400
Rated impulse withstand voltage U_{imp}	kV	4
Rated operational voltage AC (IEC)	VAC	230
Rated frequency	Hz	50/60
Rated current (I_n)	A	25
Residual operation characteristic		AC
Rated residual current	mA	300
Short circuit rating (IEC)	kA	10
Rated conditional short-circuit current (I_{nc})	kA	10
Electrical life	cycles	10000

Ambient conditions

Operating temperature	min	°C	-35
	max	°C	+70
Storage temperature	min	°C	-40
	max	°C	+80
Max altitude	m		2000

Mechanical features

Operating position	normal		Vertical plan
Fixing			35mm DIN rail
Tightening torque for terminals	max	Nm	2
	max	Ibin	15
Terminals tool			Pz 2
Conductor section	IEC	min	mm ² 2.5
		max	mm ² 35
	AWG/Kcmil	min	14
		max	kcmil 2
Mechanical life		cycles	20000
Weight		g	185
Frontal IP degree			IP20
Pollution degree			2

Dimensions

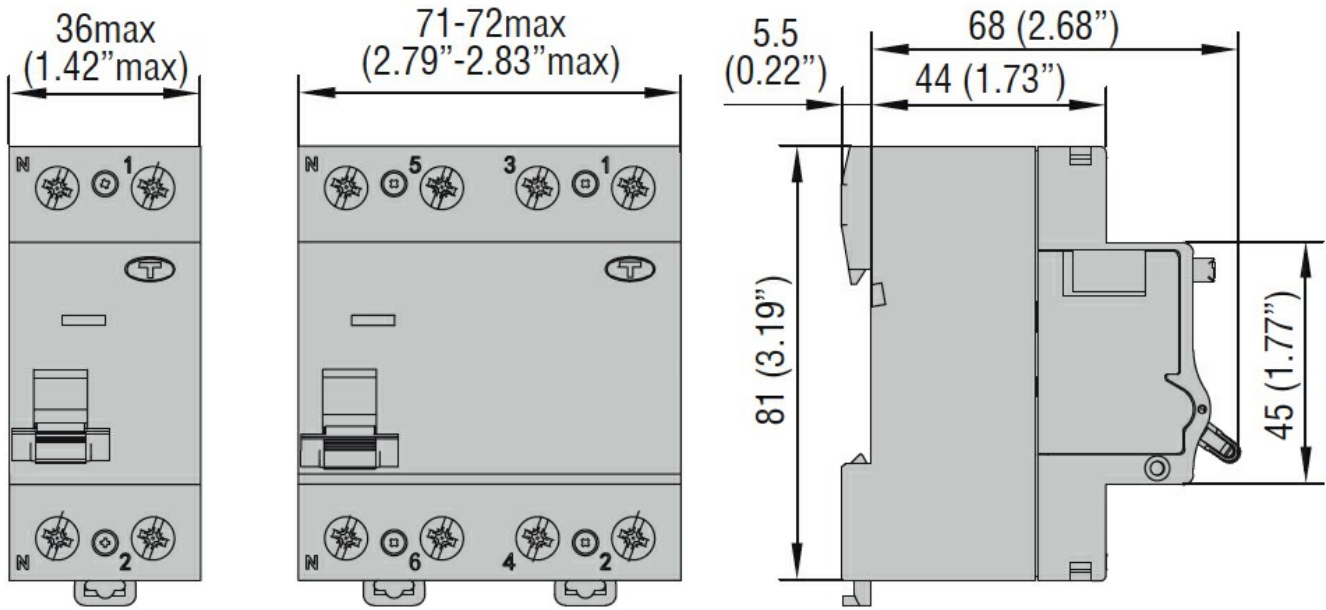

Wiring diagrams

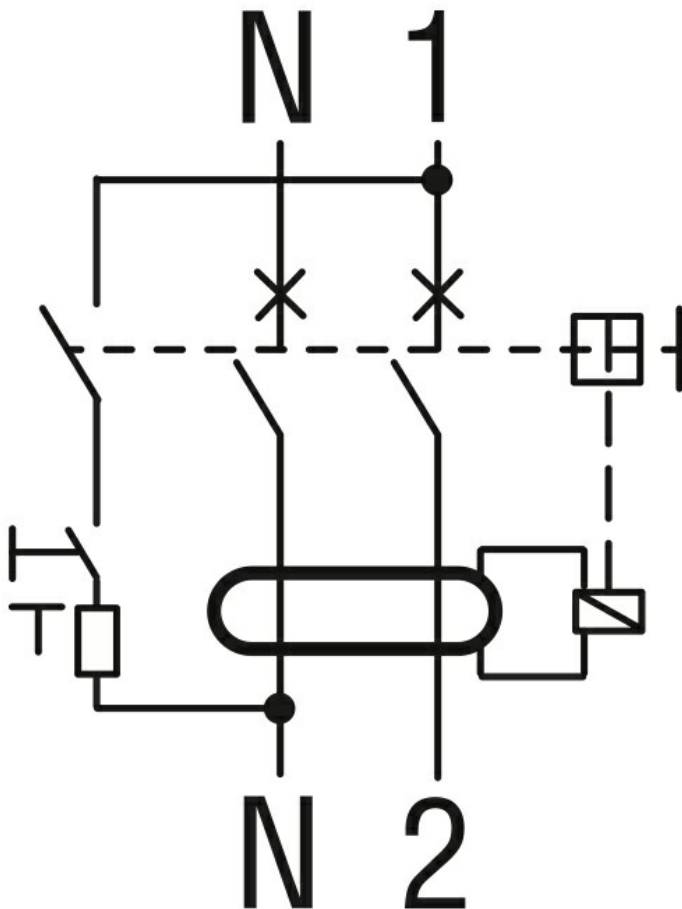

Certifications and compliance

Compliance

IEC/EN/BS 61008-1

Certifications

EAC
TÜV-Rheinland

ETIM classification

ETIM 8.0

EC000003 -
Residual current
circuit breaker
(RCCB)