



Electrical features

Rated insulation voltage U_i IEC/EN	V	440
Rated impulse withstand voltage U_{imp}	kV	4
Rated operational voltage AC (IEC)	VAC	230/400
Rated operational voltage AC (UL)	V	120
Rated operational voltage DC	VDC	60
Rated frequency	Hz	50/60
Rated current (I_n)	A	50
Tripping curve		C
Short circuit rating (IEC)	kA	10
Short circuit rating (UL)	kA	10
Electrical life	cycles	10000
Power dissipation per pole max	W	3.5

Ambient conditions

Operating temperature	min	°C	-40
	max	°C	+70
Storage temperature	min	°C	-40
	max	°C	+80
Max altitude		m	2000

Mechanical features

Operating position		normal	Vertical plan
Fixing			35mm DIN rail
Tightening torque for terminals	min	Nm	1.8
	max	Nm	2
	min	lbin	16
	max	lbin	17.7
Terminals tool			Pz 2
Conductor section	IEC	min	mm ² 1
		max	mm ² 35
	AWG/Kcmil	min	14
		max	kcmil 6
Mechanical life		cycles	20000
Weight		g	133
Frontal IP degree			IP20
Pollution degree			2

Dimensions

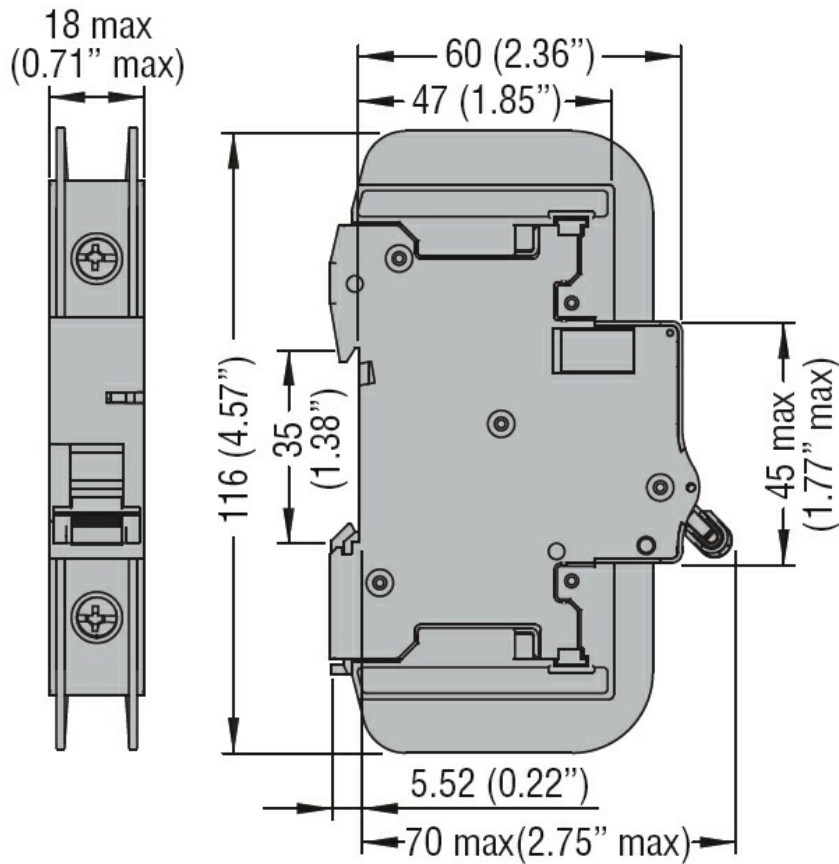

Wiring diagrams



Certifications and compliance

Compliance

IEC/EN 60947-2
 UL489

Certifications

cULus
 EAC

ETIM classification

ETIM 8.0

EC000042 -
 Miniature circuit
 breaker (MCB)