



Electrical features

Rated insulation voltage U_i IEC/EN	V	440
Rated impulse withstand voltage U_{imp}	kV	4
Rated operational voltage AC (IEC)	VAC	230/400
Rated frequency	Hz	50/60
Rated current (I_n)	A	16
Tripping curve		B
Short circuit rating (IEC)	kA	10
Limiting class		3
Electrical life	cycles	10000
Power dissipation per pole max	W	1.69

Ambient conditions

Operating temperature	min	°C	-40
	max	°C	+70
Storage temperature	min	°C	-40
	max	°C	+80
Max altitude	m		2000

Mechanical features

Operating position	normal	Vertical plan		
Fixing		35mm DIN rail		
Tightening torque for terminals	min	Nm	1.8	
	max	Nm	2	
	min	lbin	16	
	max	lbin	17.7	
Terminals tool		Pz 2		
Conductor section	IEC	min	mm ²	1
		max	mm ²	35
	AWG/Kcmil	min		14
		max	kcmil	6
Mechanical life	cycles		20000	
Weight	g		345	
Frontal IP degree			IP20	
Pollution degree			2	
Grid distance as per Annex H.1 of IEC/EN60898-1 standard	mm		60	

Dimensions

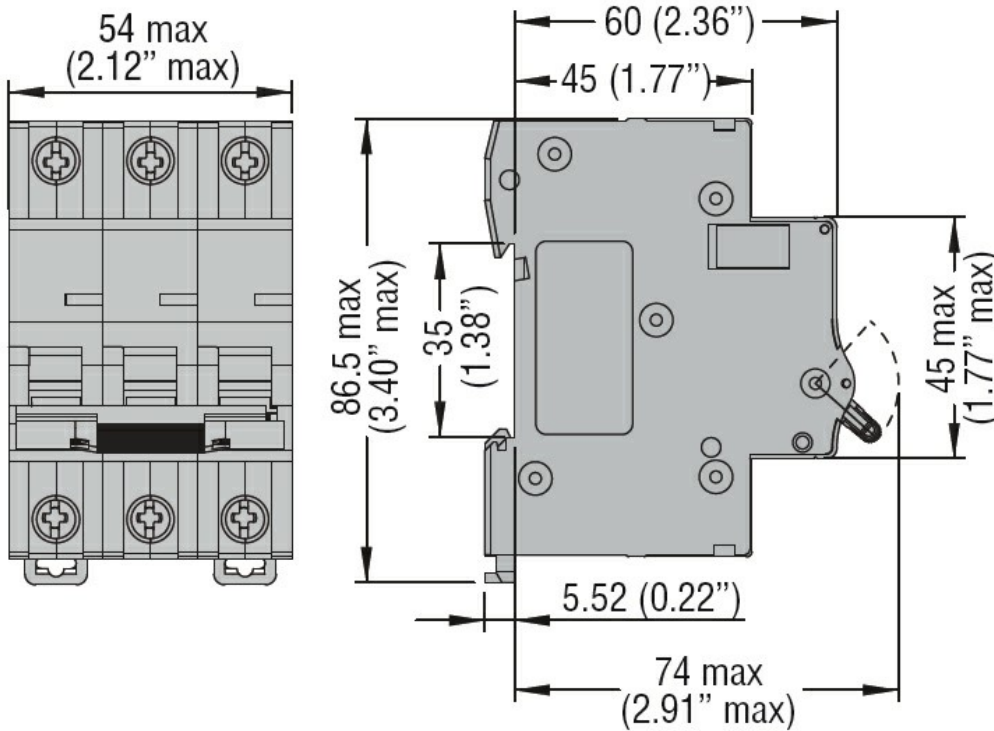

Wiring diagrams

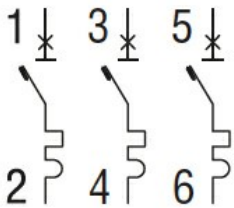

Certifications and compliance

Compliance

CSA C22.2 n°235. UR "UL Recognized" per Canada e USA.

IEC/EN 60898-1

IEC/EN 60947-2

UL 1077

Certifications

cURus

EAC

TÜV-Rheinland

ETIM classification

ETIM 8.0

EC000042 -
Miniature circuit
breaker (MCB)