



General characteristics

Material

Housing	Aluminium-zinc alloy
Roller	Plastic

Contact characteristics

Type of contact		1NO+1NC Snap action
Thermal current I _{th}	A	10
IEC/EN 60947-5-1 designation		B300 R300
Rated insulation voltage U _i	V	400
Rated impulse withstand voltage U _{imp}	kV	4
Insulation class		I
IEC Conventional free air thermal current I _{th} ≤ 40°C	A	10
Resistance per pole (average value)	mΩ	<25
Conductivity		10mA 5V

Mechanical features

Operating head fixing		Fixed
Operating torque	N	10
	lb	2.2
Tightening torque (Max)		
Switch fixing	Nm	2.5
	lbin	22.1
Cable connection		2m / 5xAWG18-0.75mm ² PVC Style 2517
Weight	g	310

Operations

Mechanical life	cycles	>10000000
Mechanical operation	cycles/h	3600

Ambient conditions

Temperature			
Operating temperature	min	°C	-25
	max	°C	+70
Storage temperature	min	°C	-40
	max	°C	+70

Resistance & Protection

IP degree	Body housing	IP67
Pollution degree		3

Dimensions

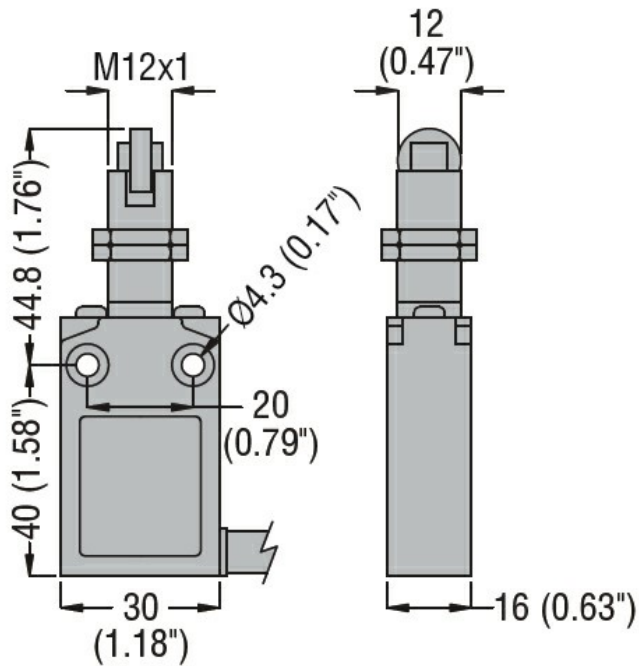

Wiring diagrams

Snap action

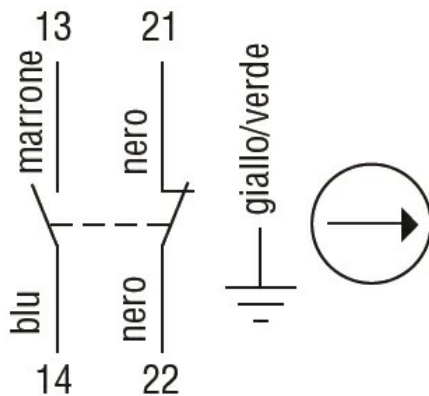

1NO + 1NC

Certifications and compliance

Compliance

CSA C22.2 n° 14.

IEC/EN 60947-1

IEC/EN 60947-5-1

UL508

Certificates

cULus

EAC

ETIM classification

ETIM 8.0

EC000030 - End switch