



General characteristics

Material

Housing	Aluminium-zinc alloy
Roller	Metal

Contact characteristics

Type of contact		2NC Slow action
Thermal current I _{th}	A	10
IEC/EN 60947-5-1 designation		A300 Q300
Rated insulation voltage U _i	V	440
Rated impulse withstand voltage U _{imp}	kV	4
Short-circuit protection with fuse	Class/A	10 gG/SC QUICK FUSE
Switching speed	min	m/s 0.5
	max	m/s 1.5
IEC Conventional free air thermal current I _{th} ≤ 40°C	A	10
Resistance per pole (average value)	mΩ	<10

Mechanical features

Operating head fixing		Locking bayonet insert
Operating torque	N	5
	lb	1.1
Tightening torque (Max)		
Switch fixing	Nm	2.5
	lbin	22.1
Contact terminals	Nm	0.8
	lbin	7
Body lid screw fixing	Nm	0.8
	lbin	7
Conductor section		
AWG/Kcmil	min	16
	max	14
IEC	min	mm ² 1.5
	max	mm ² 2.5

Cable connection	Self-releasing screw terminal
Cable entry	M20 on the sides

Operations

Mechanical life	cycles	<10000000
-----------------	--------	-----------

Mechanical operation cycles/h 3600

Ambient conditions

Temperature	Operating temperature	min	°C	-25
		max	°C	+70
	Storage temperature	min	°C	-40
		max	°C	+70

Resistance & Protection

IP degree	Terminals	IP20
	Body housing	IP65

Pollution degree 3

Dimensions

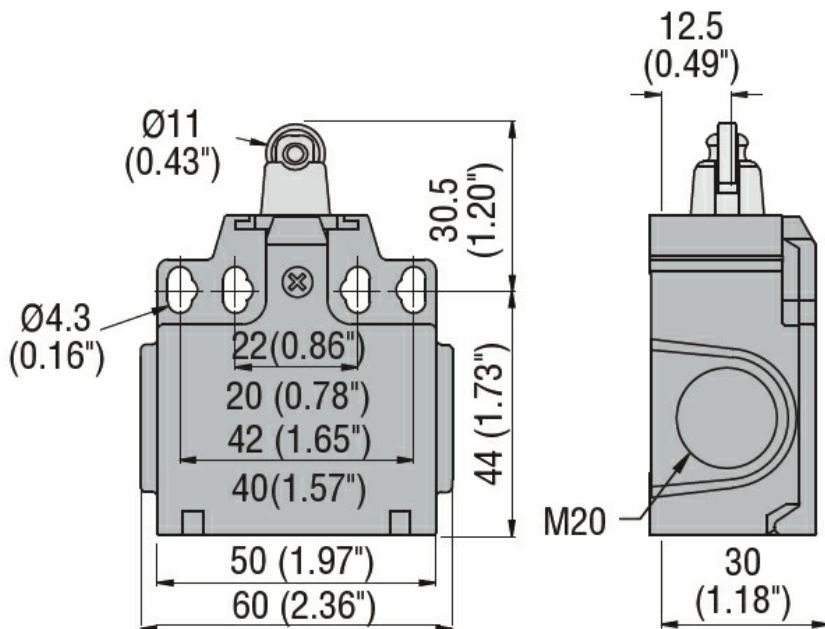

Wiring diagrams

Slow action

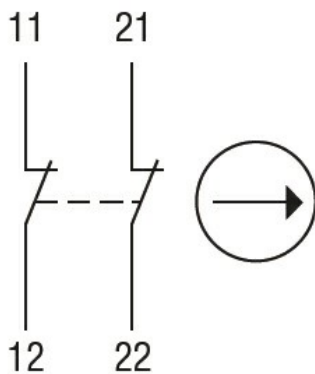

2NC

Certifications and compliance

Compliance

CSA C22.2 n° 14

EN 50047

IEC/EN 60204-1

IEC/EN 60947-1

IEC/EN 60947-5-1

UL508

Certificates

CCC

cULus

EAC

ETIM classification

ETIM 8.0

EC000030 - End
switch