



**Contact characteristics**

IEC Conventional free air thermal current $I_{th} \leq 40^\circ\text{C}$	A	80
Rated insulation voltage $U_i$ IEC/EN	V	1000
Rated impulse withstand voltage $U_{imp}$	kV	8
Operating current $I_e$		
AC21A		
400V	A	80
500V	A	80
690V	A	80
AC22A		
400V	A	80
500V	A	80
690V	A	80
AC23A		
400V	A	80
500V	A	63
690V	A	47
Power dissipation per pole max	W	2.6
Rated operational power AC23A		
400V	kW	45
690V	kW	45
Reactive power for control of capacitors at		
Conditional short-circuit current (rms)	kA	50
Short-circuit protection with fuse	Class/A	gG80
Making capacity AC23A 400V	A	1250
Breaking capacity AC23A 400V	A	1000
Mechanical life	cycles	30000
Electrical life AC21A	cycles	30000

**Mechanical features**

Operating position	normal allowable	Vertical plan Any
Terminals	type	Pillar
	width mm	12.4
	height mm	10.4
	screw	M8
	tool	Metric Allen key 4
Tightening torque for terminals	min Nm	5
	max Nm	6
	min lbin	45
	max lbin	54
Conductor section	IEC min mm <sup>2</sup>	4

IEC max	mm <sup>2</sup>	70
AWG/kcmil min		12
AWG/kcmil max	kcmil	1

**Ambient conditions**

Operating temperature

min	°C	-25
max	°C	+55

Storage temperature

min	°C	-40
max	°C	+70

Max altitude

m	3000
---	------

**Resistance & Protection**

Frontal IP degree

IP65

IP degree of protection

IP65

Pollution degree

3

**Dimensions**

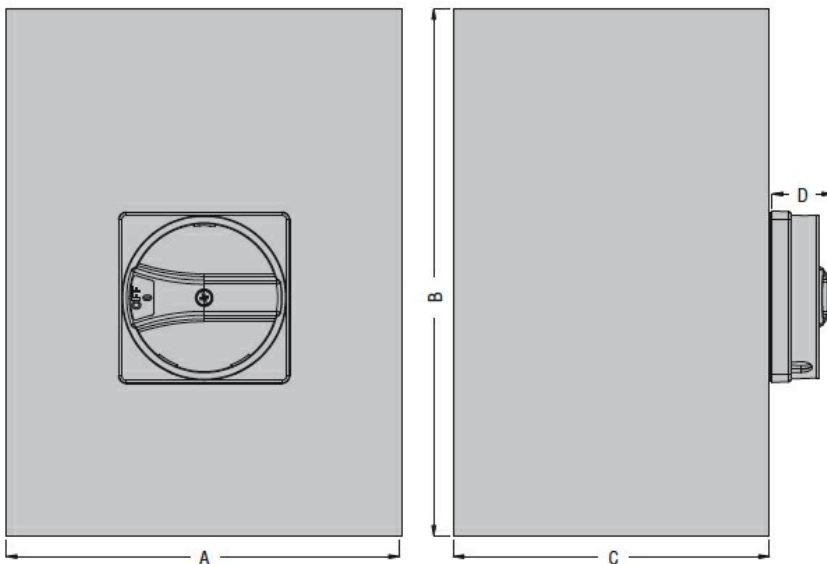

Type	A	B	C	D
GAZM063 ET6...GAZM160 ET6...	200 (7.87")	300 (11.81")	120 (4.72")	35 (1.38")

**Wiring diagrams**

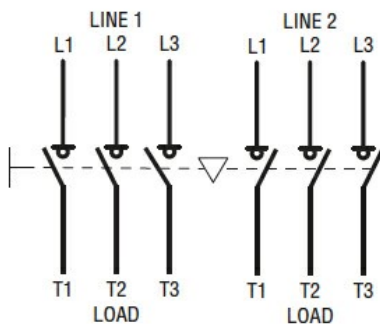

**Certifications and compliance**

Compliance

IEC/EN 60947-1

IEC/EN 60947-3

**ETIM classification**

ETIM 8.0

EC000216 -  
Switch  
disconnecter