



Contact characteristics

IEC Conventional free air thermal current $I_{th} \leq 40^{\circ}C$	A	63
Rated insulation voltage U_i IEC/EN	V	1000
Rated impulse withstand voltage U_{imp}	kV	8
Operating current I_e		
AC21A	400V	A 63
	500V	A 63
	690V	A 63
AC22A	400V	A 63
	500V	A 63
	690V	A 63
AC23A	400V	A 63
	500V	A 63
	690V	A 47
Power dissipation per pole max	W	1.6
Rated operational power AC23A	400V	kW 30
	690V	kW 45
Reactive power for control of capacitors at		
Conditional short-circuit current (rms)	kA	50
Short-circuit protection with fuse	Class/A	gG63
Making capacity AC23A 400V	A	1250
Breaking capacity AC23A 400V	A	1000
Mechanical life	cycles	30000
Electrical life AC21A	cycles	30000

Mechanical features

Operating position	normal allowable	Vertical plan Any
Terminals	type	Pillar
	width mm	12.4
	height mm	10.4
	screw	M8
	tool	Metric Allen key 4
Tightening torque for terminals	min Nm	5
	max Nm	6
	min lbin	45
	max lbin	54
Conductor section	IEC min mm ²	4

IEC max	mm ²	70
AWG/kcmil min		12
AWG/kcmil max	kcmil	1

Ambient conditions

Operating temperature

min	°C	-25
max	°C	+55

Storage temperature

min	°C	-40
max	°C	+70

Max altitude

m	3000
---	------

Resistance & Protection

Frontal IP degree

IP65

IP degree of protection

IP65

Pollution degree

3

Dimensions

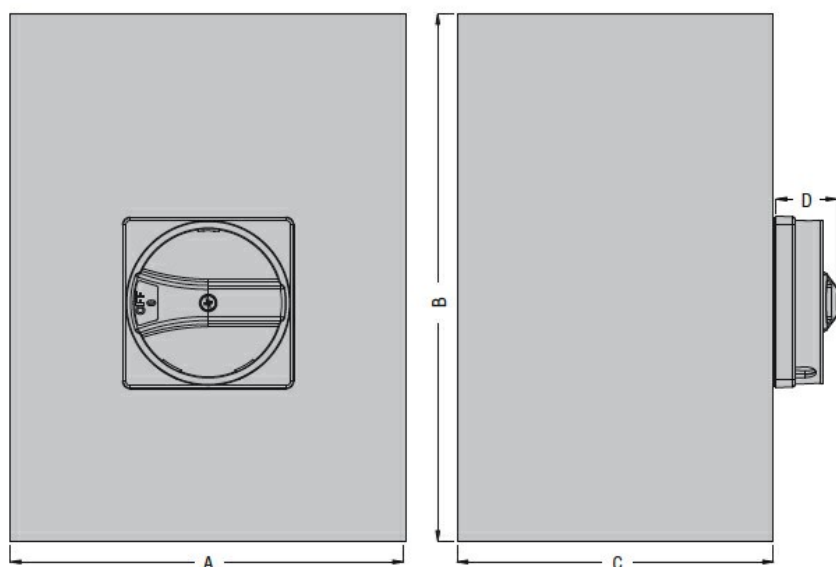

Type	A	B	C	D
GAZM016...GAZM100...	150 (5.90")	200 (7.87")	120 (4.72")	23 (0.90")

Wiring diagrams

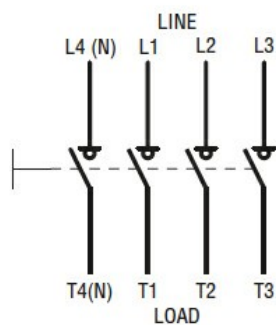

Certifications and compliance

Compliance

IEC/EN 60947-1

IEC/EN 60947-3

ETIM classification

ETIM 8.0

EC000216 -
Switch
disconnecter