



Current inputs

Primary current I_{pn} (/5)	A	2500
Operational frequency	min Hz	50
	max Hz	60
Secondary output current	A	5
Overload withstand I_{pn}	%	120
Burden	cl. 0.5s VA	10
	cl. 0.5 VA	15

Insulations

Rated insulation voltage U_i IEC/EN	V	720
IEC rated short-time thermal current I_{th}	I_{th} for s	40...60
IEC rated dynamic current I_{dyn}	I_{th} for s	2.5
Insulation dry type		Class E

Mechanical features

Terminals type	Screw
Fixing	DIN rail or by Screw
Weight	g 900

Ambient conditions

Temperature	Operating temperature		
	min	°C	-25
	max	°C	+50
	Storage temperature		
	min	°C	-40
	max	°C	+80
Relative humidity	%	90	
Protection degree		IP30	

Dimensions

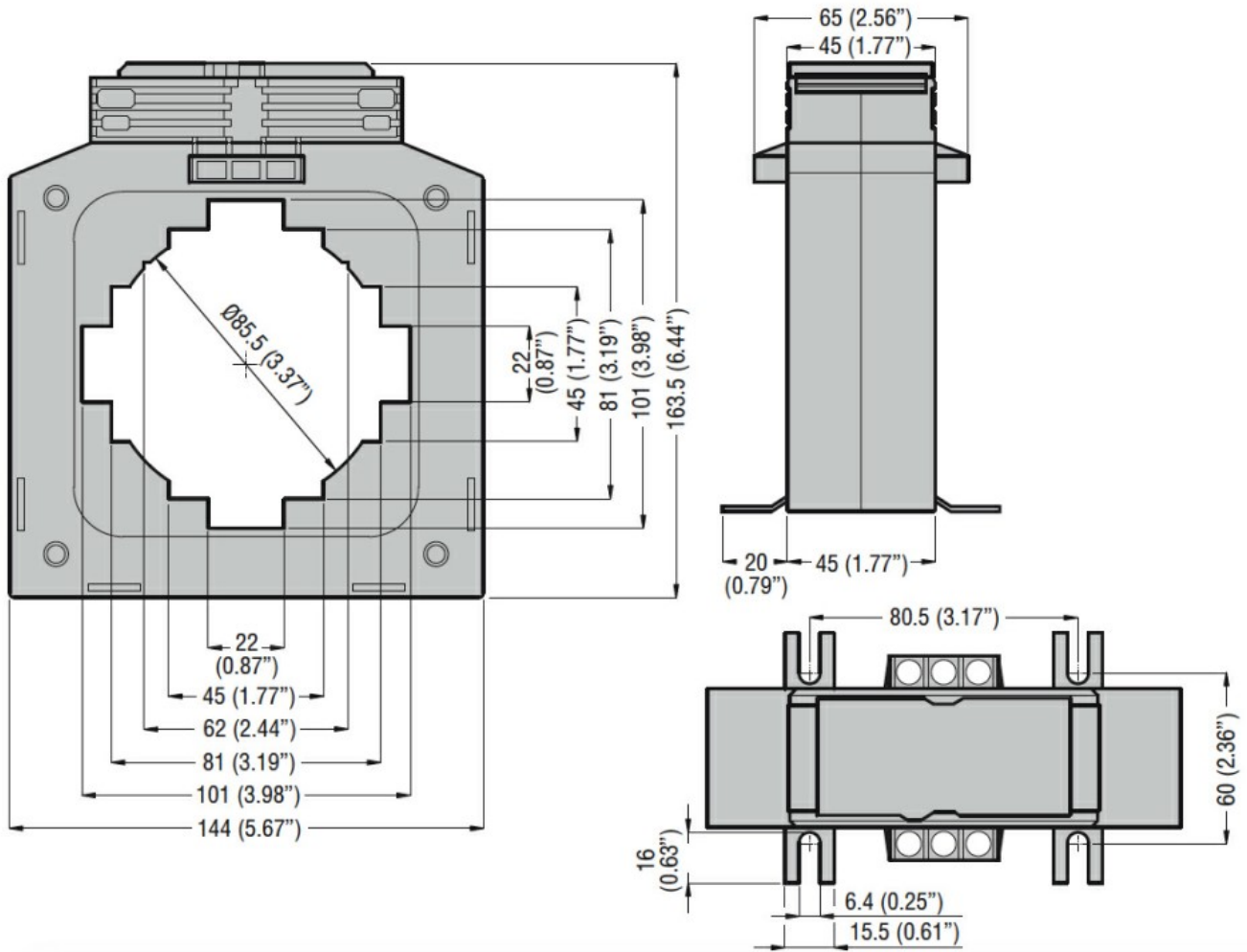

Certifications and compliance

Certifications

IEC/EN/BS 61869-1

IEC/EN/BS 61869-2

Compliance

EAC

ETIM classification

EC000066 - Power contactor, AC switching