



**Mechanical features**

Weight g 64

**UL technical data**

Rated operational voltage AC (UL) V 600

**Dimensions**

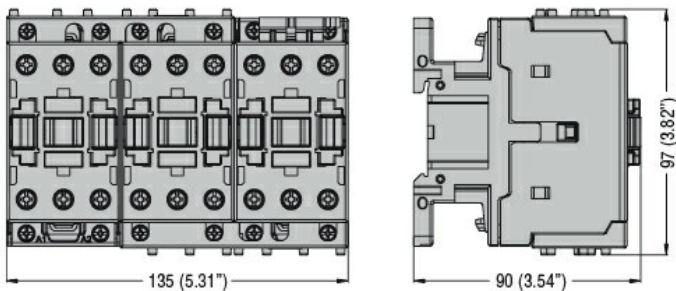

**Wiring diagrams**

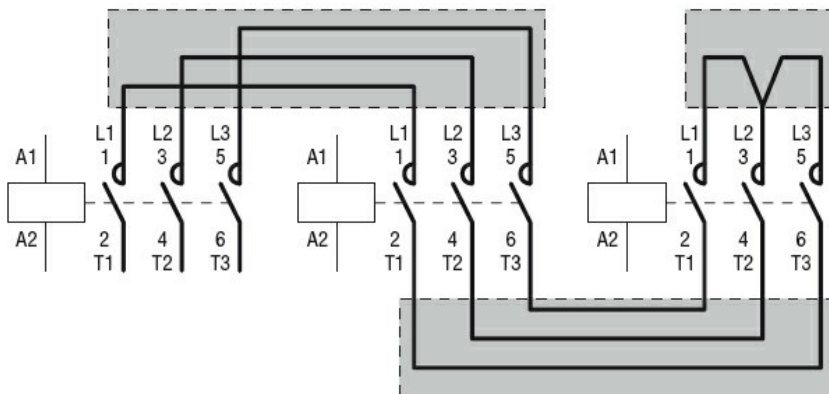

**Certifications and compliance**

**Compliance**

CSA C22.2 n° 60947-1

IEC/EN 60947-1

UL 60947-1

**Certificates**

cULus

EAC

**ETIM classification**

ETIM 8.0

EC002498 -  
Accessories/spare  
parts for low-  
voltage switch  
technology