



Contact characteristics

Number of poles	Nr.	4
Rated insulation voltage U_i IEC/EN	V	1000
Rated impulse withstand voltage U_{imp}	kV	8
Operational frequency	min	Hz 25
	max	Hz 400
IEC Conventional free air thermal current $I_{th} \leq 40^\circ\text{C}$	A	100
Operational current I_e	AC-1 ($\leq 40^\circ\text{C}$)	A 100
	AC-1 ($\leq 55^\circ\text{C}$)	A 80
	AC-1 ($\leq 70^\circ\text{C}$)	A 70
	AC-3 ($\leq 440\text{V} \leq 55^\circ\text{C}$)	A 65
	AC-4 (400V)	A 31
Rated operational current AC-3 ($T \leq 55^\circ\text{C}$)	230V	A 65
	400V	A 65
	415V	A 65
	440V	A 65
	500V	A 53
	690V	A 47
	1000V	A 25
Rated operational power AC-1 ($T \leq 40^\circ\text{C}$)	230V	kW 38
	400V	kW 65
	500V	kW 82
	690V	kW 114
IEC max current I_e in DC1 with $L/R \leq 1\text{ms}$ with 1 poles in series	$\leq 24\text{V}$	A 50
	48V	A 50
	75V	A 50
	110V	A 8
	220V	A –
IEC max current I_e in DC1 with $L/R \leq 1\text{ms}$ with 2 poles in series	$\leq 24\text{V}$	A 70
	48V	A 70
	75V	A 70
	110V	A 60
	220V	A 9
IEC max current I_e in DC1 with $L/R \leq 1\text{ms}$ with 3 poles in series	$\leq 24\text{V}$	A 70
	48V	A 70
	75V	A 70
	110V	A 60
	220V	A 90

IEC max current I_e in DC1 with L/R ≤ 1ms with 4 poles in series

≤24V	A	70
48V	A	70
75V	A	70
110V	A	70
220V	A	110

IEC max current I_e in DC3-DC5 with L/R ≤ 15ms with 1 poles in series

≤24V	A	35
48V	A	25
75V	A	25
110V	A	3
220V	A	–

IEC max current I_e in DC3-DC5 with L/R ≤ 15ms with 2 poles in series

≤24V	A	45
48V	A	40
75V	A	40
110V	A	30
220V	A	5

IEC max current I_e in DC3-DC5 with L/R ≤ 15ms with 3 poles in series

≤24V	A	55
48V	A	50
75V	A	50
110V	A	35
220V	A	52

IEC max current I_e in DC3-DC5 with L/R ≤ 15ms with 4 poles in series

≤24V	A	60
48V	A	60
75V	A	60
110V	A	50
220V	A	65

Short-time allowable current for 10s (IEC/EN60947-1)

A	640
---	-----

Protection fuse

gG (IEC)	A	125
aM (IEC)	A	80

Making capacity (RMS value)

A	650
---	-----

Breaking capacity at voltage

440V	A	520
500V	A	425
690V	A	376

Resistance per pole (average value)

mΩ	0.8
----	-----

Power dissipation per pole (average value)

I _{th}	W	8
AC-3	W	3.4

Tightening torque for terminals

min	Nm	4
max	Nm	5
min	I _{bin}	2.95
max	I _{bin}	3.69

Tightening torque for coil terminal

min	Nm	0.8
max	Nm	1
min	I _{bin}	0.8
max	I _{bin}	0.74

Max number of wires simultaneously connectable	Nr.	2	
Conductor section	AWG/Kcmil		
	max	2	
Flexible w/o lug conductor section	min	mm ²	1.5
	max	mm ²	35
Flexible c/w lug conductor section	min	mm ²	1.5
	max	mm ²	35
Power terminal protection according to IEC/EN 60529	IP20 front		
Mechanical features			
Operating position	normal allowable	Vertical plan ±30°	
Fixing	Screw / DIN rail 35mm		
Weight	g	1240	
Operations			
Mechanical life	cycles	15000000	
Electrical life	cycles	1400000	
Safety related data			
Performance level B10d according to EN/ISO 13489-1	rated load mechanical load	cycles	1400000
		cycles	15000000
EMC compatibility	yes		
AC coil operating			
Rated AC voltage at 60Hz	V	48	
AC operating voltage	of 60Hz coil powered at 60Hz		
	pick-up		
	min	%Us	80
	max	%Us	110
	drop-out		
	min	%Us	20
	max	%Us	55
AC average coil consumption at 20°C	of 60Hz coil powered at 60Hz		
	in-rush holding	VA	210
		VA	15
Dissipation at holding ≤20°C 50Hz	W	5	
Max cycles frequency			
Mechanical operation	cycles/h	3600	
Operating times			
Average time for Us control	in AC		
	Closing NO		
	min	ms	12
	max	ms	28
	Opening NO		
	min	ms	8
	max	ms	22
	in DC		

Closing NO	min	ms	40
	max	ms	85
Opening NO	min	ms	20
	max	ms	55

UL technical data

Rated operational voltage AC (UL) V 600

Full-load current (FLA) for three-phase AC motor

at 480V	A	65
at 600V	A	62

Yielded mechanical performance for three-phase AC motor

200/208V	HP	20
220/240V	HP	25
460/480V	HP	50
575/600V	HP	60

General USE

Contactor AC current A 100

Short-circuit protection fuse, 600V High fault

Short circuit current	kA	100
Fuse rating	A	200
Fuse class		J

Standard fault

Short circuit current	kA	10
Fuse rating	A	200
Fuse class		RK5

Ambient conditions

Temperature

Operating temperature

min	°C	-50
max	°C	70

Storage temperature

min	°C	-60
max	°C	80

Max altitude m 3000

Resistance & Protection

Pollution degree 3

Dimensions



① BF80T2 82mm/3.23"

Wiring diagrams

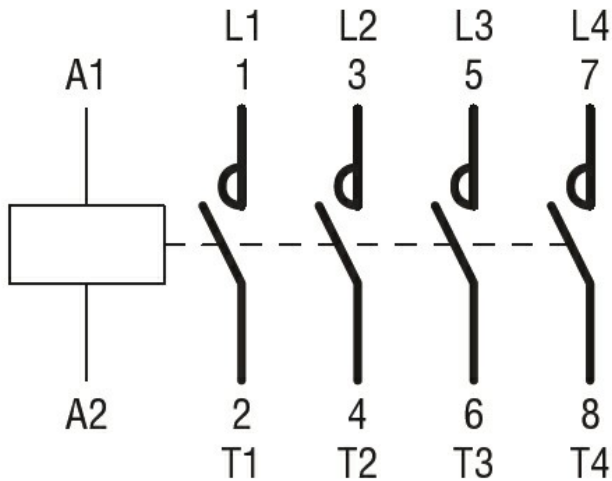

Certifications and compliance

Compliance

CSA C22.2 n° 60947-1

CSA C22.2 n° 60947-4-1

IEC/EN 60335-2-89

IEC/EN/BS 60947-1

IEC/EN/BS 60947-4-1

UL 60947-1

UL 60947-4-1

Certificates

CCC

CSA C22.2 n. 60335-2-40:22 LZGH A2L

CSA C22.2 No. 60335-2-89:21 LZGH A2L

cULus

UL 60335-2-40 LZGH A2L

UL 60335-2-89 LZGH A2L

ETIM classification

ETIM 8.0

EC000066 -
Power contactor,
AC switching